

**lenovo**

# Lenovo

## G70-70/G70-80

## Z70-80

### User Guide



Read the safety notices and important tips in the included manuals before using your computer.

## Notes

- Before using the product, be sure to read *Lenovo Safety and General Information Guide* first.
- Some instructions in this guide may assume that you are using Windows® 8.1. If you are using other Windows operating systems, some operations may be slightly different. If you are using other operating systems, some operations may not apply to you.
- The features described in this guide are common to most models. Some features may not be available on your computer and/or your computer may include features that are not described in this user guide.
- The illustrations used in this manual are from Lenovo G70-70 unless otherwise stated.
- The illustrations in this manual may differ from the actual product. Please refer to the actual product.

## Regulatory Notice

- For details, refer to **Guides & Manuals** at <http://support.lenovo.com>.

**First Edition (July 2014)**

**© Copyright Lenovo 2014.**

LIMITED AND RESTRICTED RIGHTS NOTICE: If data or software is delivered pursuant a General Services Administration "GSA" contract, use, reproduction, or disclosure is subject to restrictions set forth in Contract No. GS-35F-05925.

# Contents

<b>Chapter 1. Getting to know your computer .....</b>	<b>1</b>
Top view .....	1
Left-side view .....	7
Right-side view .....	10
Front view .....	11
Bottom view .....	13
<b>Chapter 2. Starting to use Windows 8.1 .....</b>	<b>14</b>
Configuring the operating system for the first time .....	14
Switching screens .....	14
Charms and the charms bar .....	15
Putting the computer to sleep or shutting it down .....	17
Connecting to wireless LAN .....	18
Help and support .....	19
<b>Chapter 3. Lenovo OneKey Recovery system .....</b>	<b>20</b>
<b>Chapter 4. Troubleshooting .....</b>	<b>22</b>
Frequently asked questions .....	22
Troubleshooting .....	25
<b>Appendix. CRU instructions .....</b>	<b>29</b>
Replacing the battery .....	29
Replacing the hard disk drive .....	30
Replacing memory .....	34
Replacing the Mini PCI Express Card .....	36
Replacing the fan assembly .....	39
Replacing the keyboard .....	42
Removing the optical drive .....	45
<b>Trademarks .....</b>	<b>47</b>



# Chapter 1. Getting to know your computer

## ■ ■ Top view

---

### ■ G70-70/G70-80

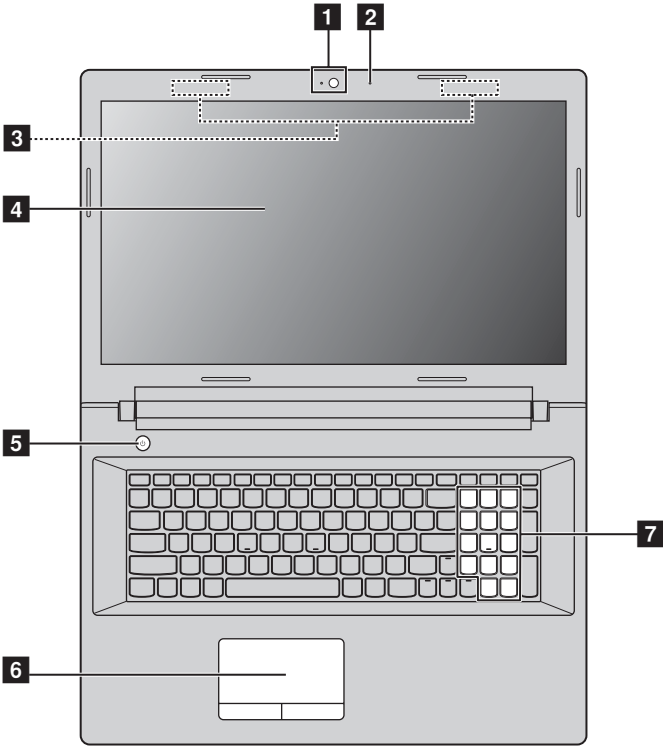

## Chapter 1. Getting to know your computer

### ■ Z70-80

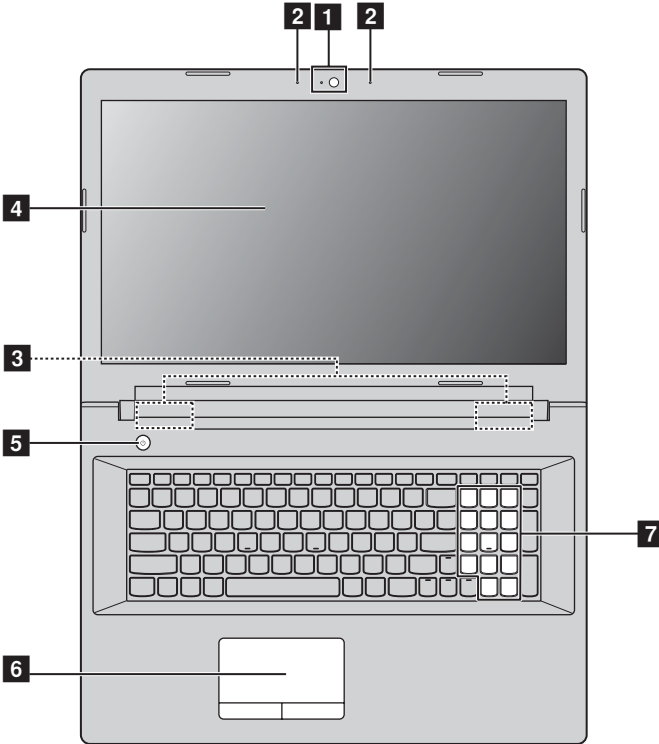

**Note:** The dashed areas indicate parts that are invisible from outside.

#### ⊙ **Attention:**

- Do *not* open the display panel beyond 130 degrees. When closing the display panel, be careful *not* to leave pens or any other objects in between the display panel and the keyboard. Otherwise, the display panel may be damaged.

## Chapter 1. Getting to know your computer

- 1 Integrated camera** Use the camera for video communication.
- 2 Built-in microphone** Captures sound which can be used for video conferencing, voice narration, or audio recording.
- 3 Wireless antennas** Connect to the wireless adapter to receive and send wireless radio.
- 4 Display** Provides brilliant visual output.
- 5 Power button** Press this button to turn on the computer.
- 6 Touch pad** The touch pad functions as a conventional mouse.

**Touch pad:** To move the pointer on the screen, slide your fingertip over the pad in the direction in which you want the pointer to move.

**Touch pad buttons:** The functions of the left/right side correspond to those of the left/right mouse button on a conventional mouse.

**Note:** You can enable or disable the Touch pad and the Touch pad buttons by pressing



- 7 Numeric keypad** For details, see “Using the keyboard” on page 4.

## Chapter 1. Getting to know your computer

### ■ Using the keyboard

Your computer has number keys and function keys and may also have a numeric keypad incorporated into its standard keyboard.

#### **Numeric keypad**

The keyboard has a separate numeric keypad. To enable or disable the numeric keypad, press the **Num Lock** key.

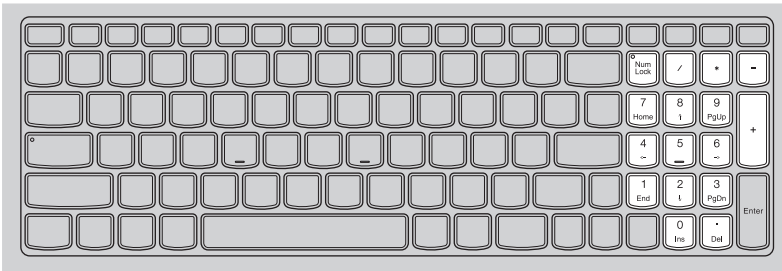



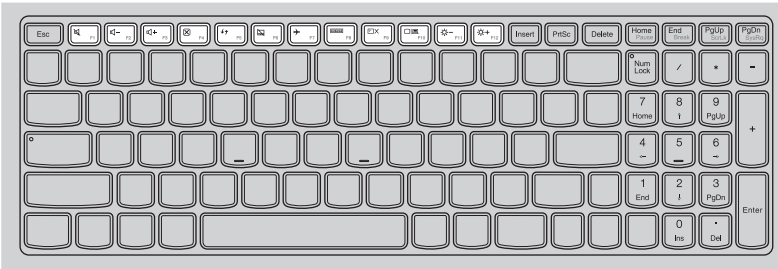

## ■ Hotkeys

You can access certain system settings quickly by pressing the appropriate hotkeys.





 : Mutes/unmutes the sound.

 : Enables/disables airplane mode.

 : Decreases the volume level.

 : Switches the active program.

 : Increases the volume level.

 : Turns on/off the backlight of the display.

 : Closes the currently active window.

 : Projects to a connected display.

 : Refreshes the desktop or the currently active window.

 : Decreases display brightness.

 : Enables/disables the touch pad and the touch pad buttons.

 : Increases display brightness.

**Note:** If you changed the **Hotkey Mode** from **Enabled** to **Disabled** in the BIOS setup utility, you will need to press the Fn key in combination with the appropriate hotkey.

## Chapter 1. Getting to know your computer

### Function key combinations

Through the use of the function keys, you can change operational features instantly. To use this function, press and hold **Fn 1**; then press one of the function keys **2**.

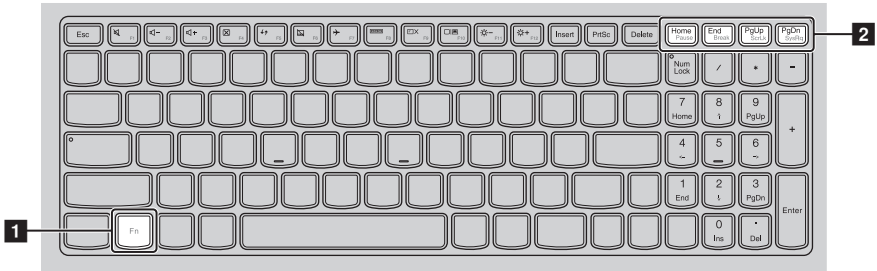

The following describes the features of each function key.

**Fn + Home:** Activate the pause function.

**Fn + End:** Activate the break function.

**Fn + PgUp:** Enable/Disable the scroll lock.

**Fn + PgDn:** Activate the system request.

### ■ ■ Left-side view

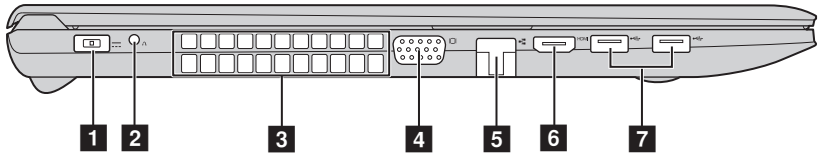

**1 AC power adapter jack** Connects the AC power adapter.

**2 Novo button** When the computer is off, press this button to start the Lenovo OneKey Recovery system or the BIOS setup utility, or to enter the boot menu.

**Note:** For details, see “Chapter 3. Lenovo OneKey Recovery system” on page 20.

**3 Ventilation slots** Dissipate internal heat.

ⓘ **Attention:**

- Make sure that none of the ventilation slots are blocked or else overheating of the computer may occur.

**4 VGA port** Connects to external display devices.

**5 RJ-45 port** Connects the computer to an Ethernet network.

**6 HDMI port** Connects to devices with HDMI input such as a TV or a display.

**7 USB ports** Connect to USB devices.

**Notes:**

- The blue port supports USB 3.0.
- For details, see “Connecting USB devices” on page 8.

## Chapter 1. Getting to know your computer

### ■ Connecting USB devices

You can connect a USB device to your computer by inserting its USB plug (Type A) into the USB port on your computer.

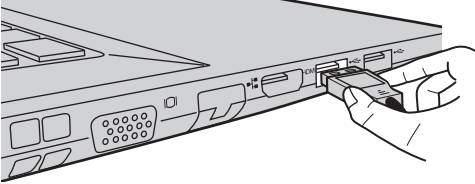

The first time you plug a USB device into a particular USB port on your computer, Windows automatically installs a driver for that device. After the driver is installed, you can disconnect and reconnect the device without performing any additional steps.

**Note:** Typically, Windows detects a new device after connecting it, and then installs the driver automatically. However, some devices may require you to install the driver before connecting. Check the documentation provided by the device's manufacturer before connecting the device.

Before disconnecting a USB storage device, make sure your computer has finished transferring data by that device. Click the **Safely Remove Hardware and Eject Media** icon in the notification area of the Windows desktop screen to remove the device before disconnecting.

**Note:** If your USB device uses a power cord, connect the device to a power source before connecting it. Otherwise, the device may not be recognized.

### ■ Connecting network cables

To insert a network cable, do the following:

- ❶ Hold one connector of the network cable to press the RJ-45 cover down gently **1**.
- ❷ Insert the connector into the RJ-45 port **2**.

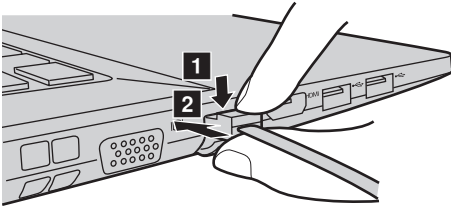

### ■ Software configuration

Consult your Internet Service Provider (ISP) for details on how to configure your computer.

## Chapter 1. Getting to know your computer

### ■ ■ Right-side view

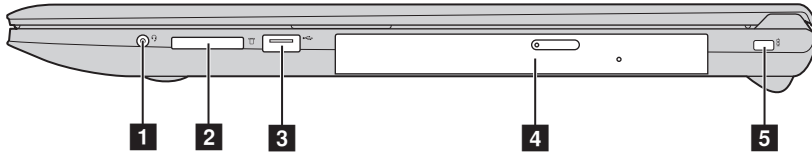

- 1 Combo audio jack** Connects to headsets.

**Notes:**

- The combo audio jack does not support conventional microphones.
- The recording function may not be supported if third-party headphones or headsets are connected, due to different industry standards.

- 2 Memory card slot** Insert memory cards (not supplied) here. For details, see “Using memory cards (not supplied)” on page 12.

- 3 USB ports** Connect to USB devices. For details, see “Connecting USB devices” on page 8.

- 4 Optical disc drive** Reads/Burns optical discs.



**Note:** Some models are supplied with a dummy optical disc drive.

- 5 Kensington slot** Attach a security lock (not supplied) here to help protect your computer from theft and unauthorized use. You can attach a security lock to your computer to help prevent it from being removed without your permission. For details on installing the security lock, please refer to the instructions shipped with the security lock that you have purchased.

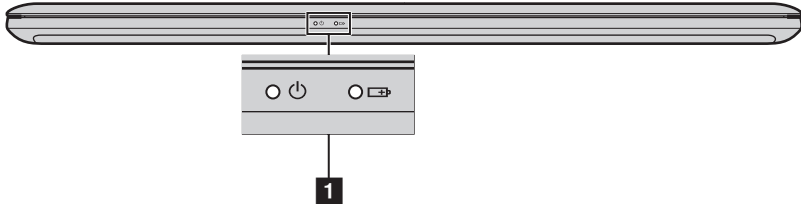
■ ■ Front view



**1 System status indicators**

Power status indicator   
 Battery status indicator 

Indicator	Indicator status	Charge Status	Meaning
<b>Power status indicator</b>	On (solid white)	—	The computer is powered on.
	Blinking	—	The computer is in sleep mode.
	Off	—	The computer is powered off.
<b>Battery status indicator</b>	On (solid white)	Discharging	The battery has more than 20% charge.
	Solid amber	Discharging	The battery has between 5% and 20% charge.
	Fast blinking amber	Charging/ Discharging	The battery has less than 5% charge.
	Slow blinking amber	Charging	The battery is being charged. When battery charge reaches 20%, the blinking color changes to white.
	Slow blinking white	Charging	The battery has between 20% and 80% charge and is still charging. When the battery reaches 80% charge the light will stop blinking, but charging will continue until the battery is fully charged.

## Chapter 1. Getting to know your computer

### ■ Using memory cards (not supplied)

Your computer supports the following types of memory card:

- Secure Digital (SD) card
- MultiMediaCard (MMC)

⦿ **Attention:**

- Insert *only* one card in the slot at a time.
- This card reader does not support SDIO devices (e.g., SDIO Bluetooth, etc.).

### Inserting a memory card

Slide a memory card in until it clicks into place.

**Note:** If a dummy card is shipped with the computer, push the dummy card and then remove it before inserting a memory card.

### Removing a memory card

Gently pull the memory card out of the memory card slot.

⦿ **Attention:**

- Before removing a memory card, disable it through **Safely Remove Hardware and Eject Media** to avoid data corruption.



■ ■ Bottom view

---

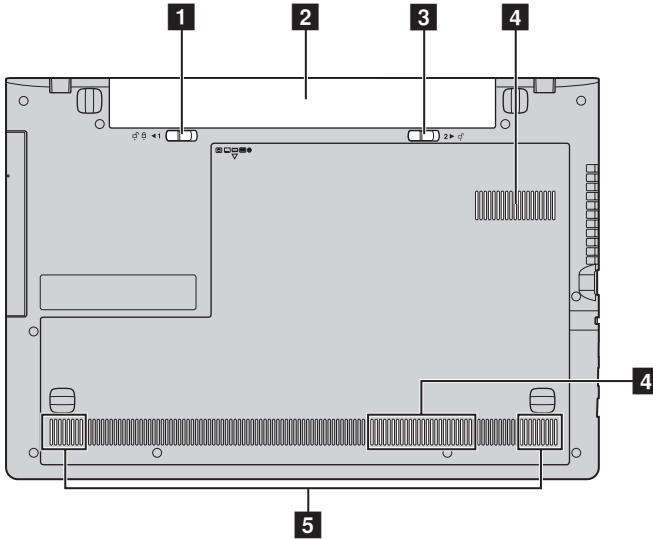

- 1 Battery latch - manual** The manual battery latch is used to keep the battery pack secured in place.
- 2 Battery pack**
- 3 Battery latch - spring loaded** The spring-loaded battery latch keeps the battery pack secured in place.
- 4 Ventilation slots** Allow air to enter the computer for cooling.
- 5 Speakers** Provide audio output.

## Chapter 2. Starting to use Windows 8.1

### ■ ■ Configuring the operating system for the first time

---

You may need to configure the operating system when it is first used. The configuration process may include the procedures below:

- Choosing a region and a language
- Accepting the license terms
- Personalizing your computer
- Configuring the Internet connection
- PC settings
- Creating a user account



### ■ ■ Switching screens

---

To switch from the Start screen to the Windows desktop, do one of the following:

- Click the **Desktop** tile on the Start screen.
- Press the Windows key  + D.

To switch from the desktop to the Start screen, do one of the following:

- Click **Start**  from the charms bar.
- Press the Windows key .
- Move the cursor to the lower-left corner, and then click the **Start** button.

To switch different apps, do the following:

- ① By using a mouse or the touch pad, move the cursor to upper-left corner and then slide it downwards.
- ② When the apps list appears, click to switch apps.

### ■ Charms and the charms bar

---

**Charms** are navigation buttons that let you access basic tasks quickly. Charms include: Search, Share, Start, Devices, and Settings. The **charms bar** is the menu that contains the charms.

To display the charms, do one of the following:

- Move the pointer to the upper-right or lower-right corner until the charms bar is displayed.
- Press Windows key  + C.

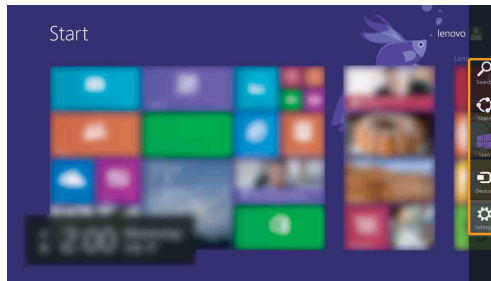

#### Search charm

The **Search** charm is a powerful new way to find what you are looking for, including settings, files, Web images, Web videos, etc.

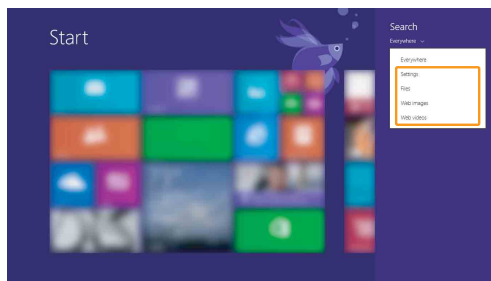

## Chapter 2. Starting to use Windows 8.1

### Share charm

The **Share** charm lets you send links, photos, and more to your friends and social networks without leaving the app you are in.

### Start charm

The **Start** charm is a fast way to go to the Start screen.

### Devices charm

The **Devices** charm allows you to connect or send files to any external devices, including the devices to play, print, and project.

### Settings charm

The **Settings** charm lets you perform basic tasks, such as setting the volume or shutting down the computer. Also, you can get to the Control Panel through the **Settings** charm when using the desktop screen.

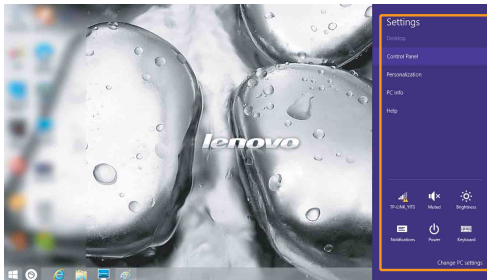

### ■ ■ Putting the computer to sleep or shutting it down



---

When you have finished working with your computer, you can put it to sleep or shut it down.

#### ■ Putting your computer to sleep

If you will be away from your computer briefly, put the computer to sleep. When the computer is in sleep mode, you can quickly wake it to resume use, bypassing the startup process.

To put the computer to sleep, do one of the following:

- Close the display lid.
- Press the Power button.
- Right-click the **Start** button in the lower-left corner and select **Shut down or sign out** → **Sleep**.
- Open the charms and then select **Settings**  → **Power**  → **Sleep**.

**Note:** Put your computer to sleep before you move it. Moving your computer while the hard disk drive is spinning can damage the hard disk, causing loss of data.

To wake the computer, do one of the following:

- Press any key on the keyboard.
- Press the Power button.

**Note:** Only available to the factory settings.

#### ■ Shutting down the computer

If you are not going to use your computer for a long time, shut it down.

To shut down the computer, do one of the following:



- Press and hold or right-click the **Start** button in the lower-left corner and select **Shut down or sign out** → **Shut down**.
- Open the charms bar and select **Settings**  → **Power**  → **Shut down**.

## Chapter 2. Starting to use Windows 8.1

### ■ ■ Connecting to wireless LAN

#### Enabling wireless connection

To enable wireless functions, do one of the following:

- Press F7 (  ) to disable the Airplane mode if the mode is enabled.
- Open the charms, and select **Settings**  →  to open the Network configuration page. Toggle the Airplane mode switch to **Off**.

#### Connecting to a wireless LAN

After wireless has been enabled, the computer will automatically scan for available wireless networks and display them in the wireless LAN network list. To connect to a wireless network, click the network name in the list, and then click **Connect**.

**Note:** Some networks require a network security key or passphrase for connection. To connect to one of those networks, ask the network administrator or the Internet Service Provider (ISP) for the security key or passphrase.

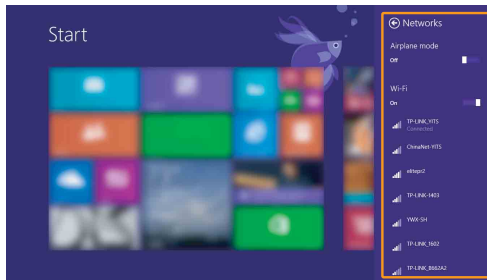

### ■ ■ Help and support

---

If you have any problems using the operating system, see the Windows Help and Support file. To open the Windows Help and Support file, do one of the following:

- Select the **Settings** charm, then select **Help**.
- Press **F1** or **Fn + F1** (depending on your keyboard layout).

You can read the Windows Help and Support file on your computer. You can also get online help and support by clicking the link listed under **More to explore**.

**Note:** A new app, **Help + Tips**, is also available on the Start screen for you to learn new features of Windows 8.1.

## Chapter 3. Lenovo OneKey Recovery system

The Lenovo OneKey Recovery system is software designed to back up and restore your computer. You can use it to restore the system partition to its original status in case of a system failure. You can also create user backups for easy restoration as required.

### Notes:

- If your computer is preinstalled with an operating system other than Windows, OneKey Recovery system is not available.
- To utilize the features of the OneKey Recovery system, your hard disk already includes a hidden partition by default to store the system image file and the OneKey Recovery system program files. This default partition is hidden for security reasons, which explains why the available disk space is less than the stated capacity.

### ■ Backing up the system partition

You can back up the system partition to an image file. To back up the system partition:

- ① Press the Novo button to start the Lenovo OneKey Recovery system.
- ② Click **System Backup**.
- ③ Select a back-up location and click **Next** to start the backup.

### Notes:

- You can choose a back-up location on the local hard disk drive or an external storage device.
- Remove the removable hard disk drive before starting the Lenovo OneKey Recovery system. Otherwise, data from the removable hard disk drive might be lost.
- The back-up process may take a while.
- The back-up process is only available when Windows can be started normally.

### ■ Restoring

You can choose to restore the system partition to its original status or to a previously created back-up point. To restore the system partition:

- ① Press the Novo button to start the Lenovo OneKey Recovery system.
- ② Click **System Recovery**. The computer will restart to the recovery environment.
- ③ Follow the on-screen instructions to restore the system partition to its original status or to a previously created back-up point.

### Notes:

- The recovery process is irreversible. Make sure to back up any data you wish to save on the system partition before starting the recovery process.
- The recovery process may take a while. So be sure to connect the AC power adapter to your computer during the recovery process.
- The above instructions should be followed when Windows can be started normally.



## Chapter 3. Lenovo OneKey Recovery system

If Windows cannot be started, follow the steps below to start the Lenovo OneKey Recovery system:

- ❶ Shut down the computer.
- ❷ Press the Novo button. From the **Novo button menu**, select **System recovery** and press Enter.

# Chapter 4. Troubleshooting

## ■ ■ Frequently asked questions

---

This section lists frequently asked questions by category.

### ■ Finding information

#### **What safety precautions should I follow when using my computer?**

The *Lenovo Safety and General Information Guide* which came with your computer contains safety precautions for using your computer. Read and follow all the precautions when using your computer.

#### **Where can I find the hardware specifications for my computer?**

You can find hardware specification for your computer from the printed flyers which came with your computer.

#### **Where can I find warranty information?**

For the warranty applicable to your computer, including the warranty period and type of warranty service, see the Lenovo limited warranty flyer that came with your computer.

### ■ Drivers

#### **Where can I find drivers for the various hardware devices of my computer?**

If your computer is preinstalled with a Windows operating system, Lenovo provides drivers for the hardware devices that you need on the C or D partition of your hard disk. You can also download the latest device drivers from the Lenovo consumer support Web site.

### ■ Lenovo OneKey Recovery system

#### Where are the recovery discs?

Your computer did not come with recovery discs. Use the Lenovo OneKey Recovery system if you need to restore the system to its factory status.

#### What can I do if the back-up process fails?

If you can start the backup but it fails during the back-up process, try the following steps:

- ❶ Close all open programs, and then restart the back-up process.
- ❷ Check to see if the destination media is damaged. Select another path and then try again.

#### When do I need to restore the system to its factory status?

Use this feature when the operating system fails to start up. If there is critical data on the system partition, back it up before starting recovery.

### ■ BIOS setup utility

#### What is the BIOS setup utility?

The BIOS setup utility is ROM-based software. It communicates basic computer information and provides options for setting boot devices, security, hardware mode, and other preferences.

#### How can I start the BIOS setup utility?

To start the BIOS setup utility, do one of the following:

- Shut down the computer. Press the Novo button and then select **BIOS Setup**.
- Press **Fn + F2** at start-up.

#### How can I change the boot mode?

There are two boot modes: **UEFI** and **Legacy Support**. To change the boot mode, start the BIOS setup utility and set boot mode to **UEFI** or **Legacy Support** on the boot menu.

## Chapter 4. Troubleshooting

### When do I need to change the boot mode?

The default boot mode for your computer is **UEFI** mode. If you need to install a legacy Windows operating system (that is, any operating system before Windows 8) on your computer, you must change the boot mode to **Legacy Support**. The legacy Windows operating system cannot be installed if you don't change the boot mode.

### ■ Getting help

#### How can I contact the customer support center?

See “Chapter 3. Getting help and service” of *Lenovo Safety and General Information Guide*.

## ■ ■ Troubleshooting

### Display problems

When I turn on the computer, nothing appears on the screen.

- If the screen is blank, make sure that:
  - The AC power adapter is connected to the computer, and the power cord is plugged into a working electrical outlet.
  - The computer power is on. (Press the power button again for confirmation.)
  - If you are using the AC power adapter or the battery, and the battery status indicator is on, press **F12** () to make the screen brighter.

When I turn on the computer, only a white cursor appears on a blank screen.

- If these items are properly set, and the screen remains blank, have the computer serviced.
- Restore backed-up files to your Windows environment or the entire contents of your hard disk to its original factory contents using the Lenovo OneKey Recovery system. If you still see only the cursor on the screen, have the computer serviced.

My screen goes blank while the computer is on.

- Your screen saver or power management may be enabled. Do one of the following to exit from the screen saver or to resume from sleep mode:
  - Touch the touch pad.
  - Press any key on the keyboard.
  - Press the power button.
  - Press **F9** () to confirm whether the backlight for the LCD screen has been turned off.
  - If the problem persists, follow the solution in the next problem “The screen is unreadable or distorted.”

The screen is unreadable or distorted.

- Make sure that:
  - The display device driver is installed correctly.
  - The screen resolution and color quality are correctly set.
  - The monitor type is correct.

## Chapter 4. Troubleshooting

Incorrect characters appear on the screen.

- Are the operating system or programs installed correctly? If they are installed and configured correctly, have the computer serviced.

### BIOS password problems

I forgot my password.

- If you forget your user password, you must ask the system administrator to reset your user password.
- If you forget your HDD password, a Lenovo authorized servicer cannot reset your password or recover data from the hard disk. You must take your computer to a Lenovo authorized servicer or a marketing representative to have the hard disk drive replaced. Proof of purchase is required, and a fee will be charged for parts and service.
- If you forget your administrator password, a Lenovo authorized servicer cannot reset your password. You must take your computer to a Lenovo authorized servicer or a marketing representative to have the system board replaced. Proof of purchase is required, and a fee will be charged for parts and service.

### Sleep problems

The critical low-battery error message appears, and the computer immediately turns off.

- The battery power is getting low. Connect the AC power adapter to the computer, or replace the battery with a fully charged one.

The computer enters sleep mode immediately after Power-on self-test (POST).

- Make sure that:
  - The battery is charged.
  - The operating temperature is within the acceptable range. See “Chapter 2. Use and care Information” of *Lenovo Safety and General Information Guide*.

**Note:** If the battery is charged and the temperature is within range, have the computer serviced.

The computer does not return from sleep mode, and the computer does not work.

- If your computer is in sleep mode, connect the AC power adapter to the computer and then press any key or the power button.
- If the system still does not return from sleep mode, stops responding, or cannot be turned off, reset the computer. Unsaved data may be lost. To reset the computer, press and hold the power button for 4 seconds or more.

### Sound problems

No sound can be heard from the speaker even when the volume is turned up.

- Make sure that:
  - The mute function is off.
  - The combo audio jack is not used.
  - The speaker is selected as the playback device.

### Battery problems

Your computer shuts down before the battery status indicator shows empty.

-or-

Your computer operates after the battery status indicator shows empty.

The computer does not operate with a fully charged battery.

- Reset the battery gauge using Lenovo Energy Management. If the problem persists, replace with a new battery pack.
- The surge protector in the battery might be active. Turn off the computer for one minute to reset the protector; then turn on the computer again.

### A hard disk drive problem

The hard disk drive does not work.

- In the **Boot** menu in the BIOS setup utility, make sure that the hard disk drive is included in the **EFI** list.

## Chapter 4. Troubleshooting

### Other problems

Your computer does not respond.

- To turn off your computer, press and hold the power button for 4 seconds or more. If the computer still does not respond, remove the battery pack and the AC power adapter.
- Your computer might lock when it enters sleep mode during a communication operation. Disable the sleep timer when you are working on the network.

I need to start the computer from a connected device, but the device does not appear on the boot device list.

- Check the boot mode setting in the BIOS setup utility. If **Boot Mode** is set to **UEFI**, make sure that the device or the medium in the device supports UEFI boot. If the device or the medium in the device does not support UEFI boot, set **Boot Mode** to **Legacy Support**. If the device still does not appear in the boot device list, replace with a new device or medium.

The connected external device does not work.

- Do not connect or disconnect any external device cables other than USB while the computer power is on; otherwise, you might damage your computer.
- When using a high power consumption external device such as an external USB optical disk drive, use an external device power adapter. Otherwise, the device may not be recognized, or system shut down may result.



## Appendix. CRU instructions

### Notes:

- The CRU service is only applicable to certain countries.
- The illustrations used in this appendix are for the Lenovo G70-70, unless otherwise stated.
- Make sure the battery has been removed before replacing any devices.

## ■ Replacing the battery

**Note:** Use only the battery provided by Lenovo. Any other battery could ignite or explode.

To replace the battery, do the following:

- ① Turn off the computer. Disconnect the AC power adapter and all cables from the computer.
- ② Close the computer display, and turn the computer over.
- ③ Unlock the manual battery latch **1**. Slide the spring-loaded latch to the unlocked position to eject the battery pack **2**. Lift up the inner edge of the battery pack, pivoting it on the outer edge **3**. Slide the battery pack in the indicated direction to remove it **4**.

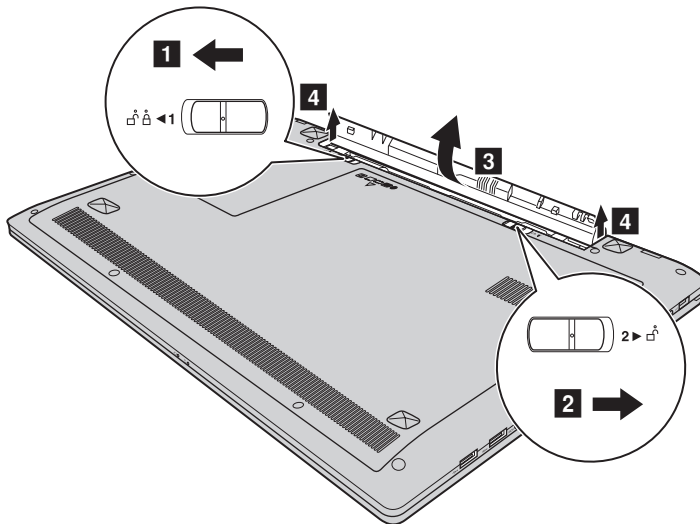

- ④ Install a fully charged battery.
- ⑤ Slide the manual battery latch to the locked position.
- ⑥ Turn the computer over again.
- ⑦ Connect the AC power adapter and the cables to the computer.

## Appendix. CRU instructions

### ■ ■ Replacing the hard disk drive

---

You can increase the storage capacity of your computer by replacing the hard disk drive with one of greater capacity. You can purchase a new hard disk drive from your reseller or Lenovo marketing representative.

**Notes:**

- Replace the hard disk drive only if you upgrade it or have it repaired. The connectors and bay of the hard disk drive were not designed for frequent changes, or drive swapping.
- The preinstalled software is not included on an optional hard disk drive.

#### **Handling a hard disk drive**

- Do not drop the drive or subject it to physical shocks. Put the drive on a material, such as soft cloth, that absorbs the physical shock.
- Do not apply pressure to the cover of the drive.
- Do not touch the connector.

The hard disk drive is very sensitive. Incorrect handling may cause damage and permanent loss of data on it. Before removing the hard disk drive, make a backup copy of all the information on it, and then turn the computer off. Never remove the drive while the system is operating in sleep mode.

To replace the hard disk drive, do the following:

- ① Turn off the computer. Disconnect the AC power adapter and all cables from the computer.
- ② Close the computer display, and turn the computer over.
- ③ Remove the battery pack. For details, see “Replacing the battery” on page 29.
- ④ Remove the Hard disk drive/Memory/Central processing unit/Mini PCI Express Card slot compartment cover.
  - a. Loosen the screws that secure the compartment cover **1**.
  - b. Remove the compartment cover **2**.

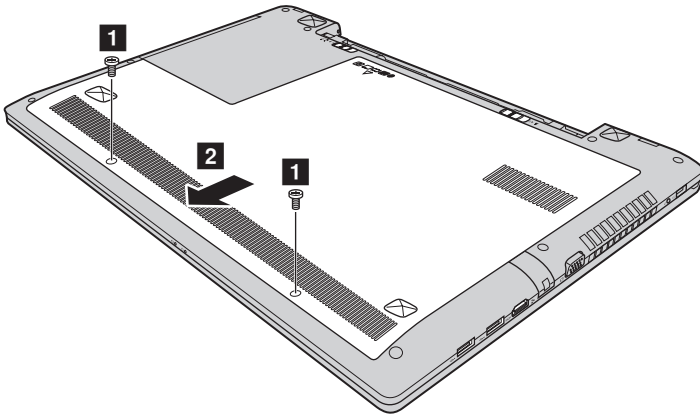

## Appendix. CRU instructions

- 5 Remove the frame fixing screws 3 .

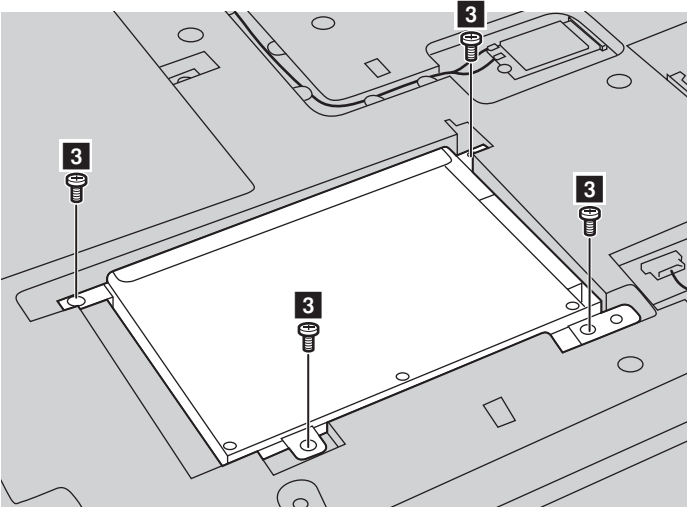

- 6 Pull the tab in the direction shown by arrow 4 .

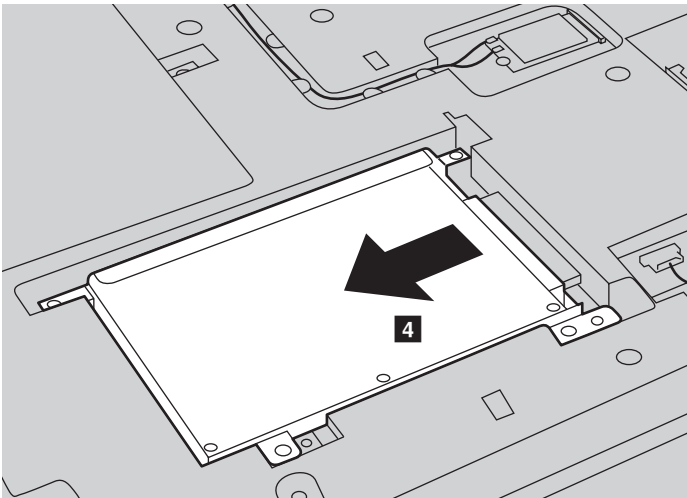

- 7 Take out the hard disk drive secured in a metal frame 5.

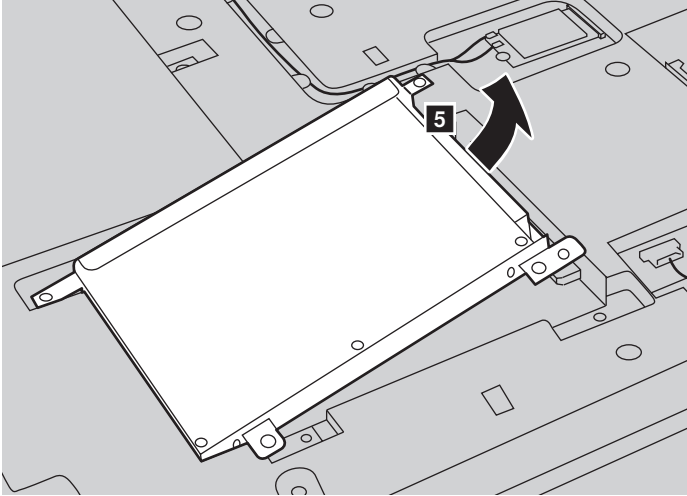

- 8 Remove the screws and detach the metal frame from the hard disk drive.  
9 Attach the metal frame to a new hard disk drive and tighten the screws.  
10 Put the hard disk drive gently into the hard disk drive bay with the tab facing upwards and the connectors facing each other, then push it firmly into space.  
11 Reinstall the frame fixing screw.  
12 Reinstall the compartment cover and tighten the screws.  
13 Reinstall the battery pack.  
14 Turn the computer over again.  
15 Connect the AC power adapter and the cables to the computer.

## Appendix. CRU instructions

### ■ ■ Replacing memory

You can increase the amount of memory in your computer by installing a double-data-rate three low voltage synchronous dynamic random access memory (DDR3L SDRAM)-available as an option in the memory slot of your computer. DDR3L SDRAMs are available in various capacities.

**Note:** Use only the memory types supported by your computer. If you incorrectly install optional memory, or install an unsupported memory type, a warning beep will sound when you try to start the computer.

To replace a DDR3L SDRAM, do the following:

- ❶ Touch a metal table or a grounded metal object to reduce any static electricity in your body, which could damage the DDR3L SDRAM. Do not touch the contact edge of the DDR3L SDRAM.
- ❷ Turn off the computer. Disconnect the AC power adapter and all cables from the computer.
- ❸ Close the computer display, and turn the computer over.
- ❹ Remove the battery pack. For details, see “Replacing the battery” on page 29.
- ❺ Remove the Hard disk drive/Memory/Central processing unit/Mini PCI Express Card slot compartment cover.
  - a. Loosen the screws that secure the compartment cover ❶.
  - b. Remove the compartment cover ❷.

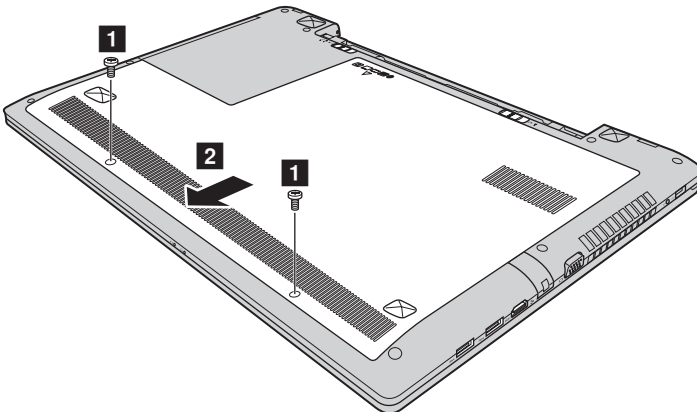

- 6 If two DDR3L SDRAMs are already installed in the memory slot, remove one of them to make room for the new one by pressing out on the latches on both edges of the socket at the same time. Be sure to save the old DDR3L SDRAM for future use.

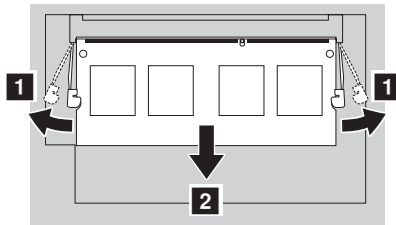

- 7 Align the notch of the DDR3L SDRAM with the protrusion of the socket and gently insert the DDR3L SDRAM into the socket at a 30-45° angle.
- 8 Push the DDR3L SDRAM inward toward the socket until the latches on both edges of the socket are pushed into the closed position.

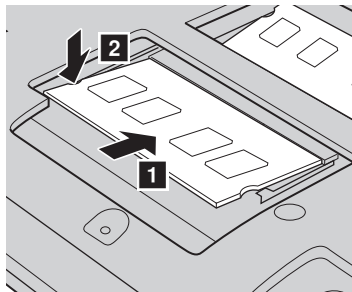

- 9 After aligning the attachment clips with their matching gaps, reinstall the compartment cover.
- 10 Reinstall and tighten the screws.
- 11 Reinstall the battery.
- 12 Turn the computer over again.
- 13 Connect the AC power adapter and the cables to the computer.

To make sure that the DDR3L SDRAM is installed correctly, do as follows:

- 1 Turn the computer on.
- 2 Hold **Fn + F2** during startup. The BIOS setup utility screen opens. The **System Memory** item shows the total amount of memory installed in your computer.

## Appendix. CRU instructions

### ■ ■ Replacing the Mini PCI Express Card

To replace the Mini PCI Express Card, do the following:

- ❶ Turn off the computer. Disconnect the AC power adapter and all cables from the computer.
- ❷ Close the computer display, and turn the computer over.
- ❸ Remove the battery pack. For details, see “Replacing the battery” on page 29.
- ❹ Remove the Hard disk drive/Memory/Central processing unit/Mini PCI Express Card slot compartment cover.
  - a. Loosen the screws that secure the compartment cover ❶.
  - b. Remove the compartment cover ❷.

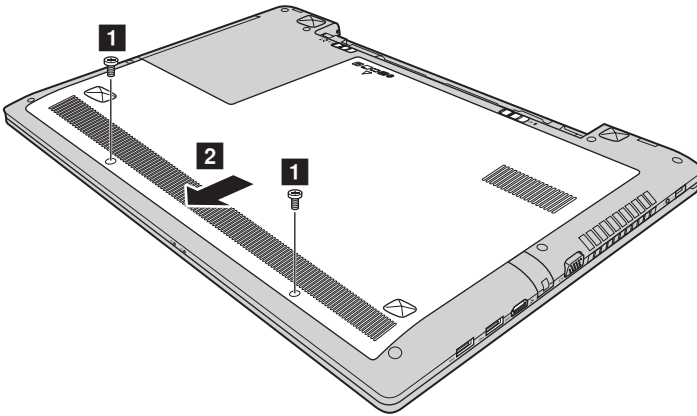



## Appendix. CRU instructions

- 6 If a tool for removing connectors is included in the package with the new card, use it to disconnect the cables **3** from the card. If no such tool is included, disconnect the cables by holding up the connectors with your fingers and gently unplugging them. Then remove the screws **4** and the card pops up.

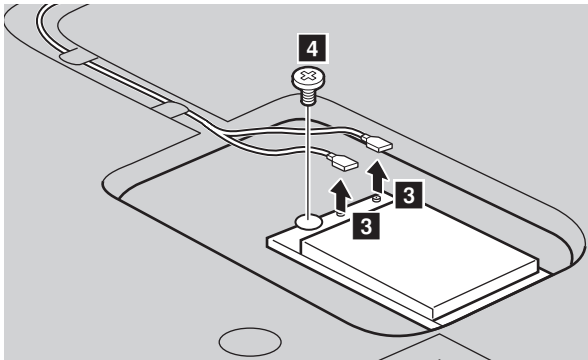

- 6 Remove the card in the direction shown by **5**.

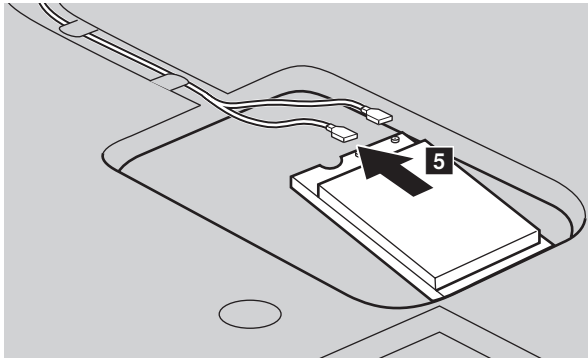

- 7 Align the contact edge of the new Mini PCI Express Card with the corresponding socket.
- 8 Pivot the card until you can snap it into place. Then secure the card with the screw.
- 9 Connect the antenna cables to the new Mini PCI Express Card. Be sure to attach the gray cable to the connector marked "MAIN" or "M" on the card, and the black cable to the connector marked "AUX" or "A".

## Appendix. CRU instructions

- ⑩ Reinstall the compartment cover and tighten the screws.
- ⑪ Reinstall the battery pack.
- ⑫ Turn the computer over again.
- ⑬ Connect the AC power adapter and the cables to the computer.

## ■ ■ Replacing the fan assembly

---

To replace the fan assembly, do the following:

- ❶ Turn off the computer. Disconnect the AC power adapter and all cables from the computer.
- ❷ Close the computer display, and turn the computer over.
- ❸ Remove the battery pack. For details, see “Replacing the battery” on page 29.
- ❹ Remove the Hard disk drive/Memory/Central processing unit/Mini PCI Express Card slot compartment cover.
  - a. Loosen the screws that secure the compartment cover **❶**.
  - b. Remove the compartment cover **❷**.

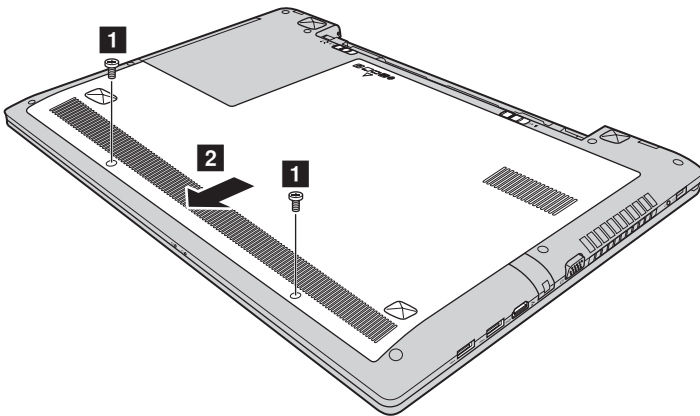

## Appendix. CRU instructions

- 5 Detach the fan connector in the direction shown by arrow **3** and loosen the three screws **4** to lift the fan assembly.

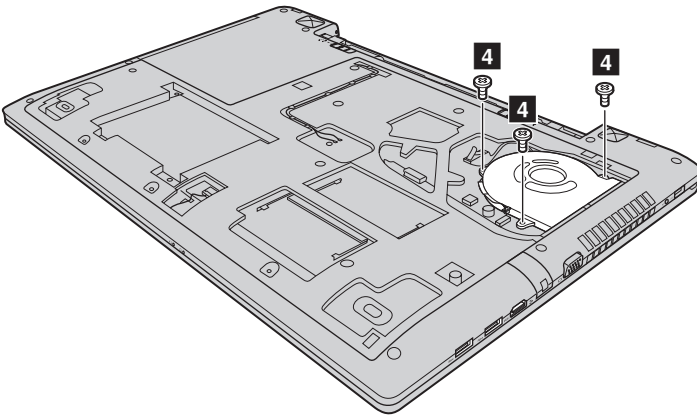
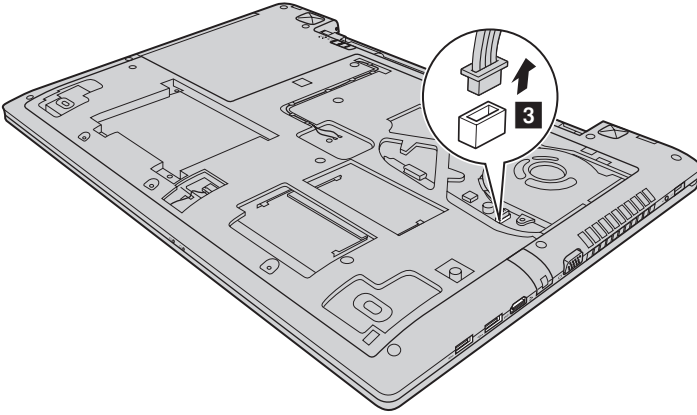

## Appendix. CRU instructions

- 6 Lift the fan assembly in the direction shown by arrow 5. Be careful not to damage the connector.

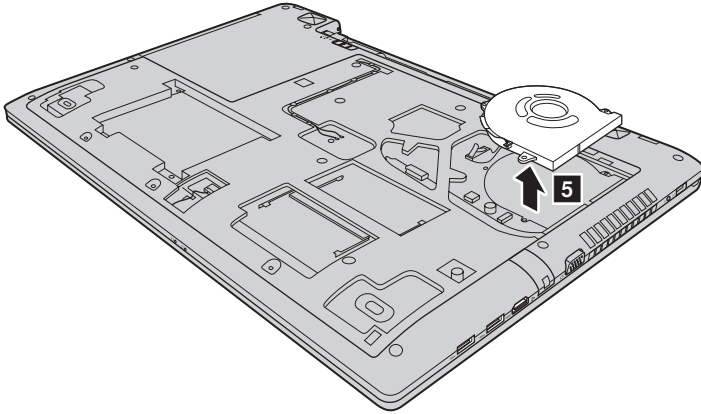

- 7 Reinstall the new fan assembly, tighten the screws, and attach the connector.
- 8 Reinstall the compartment cover and tighten the screws.
- 9 Reinstall the battery pack.
- 10 Turn the computer over again.
- 11 Connect the AC power adapter and the cables to the computer.

## Appendix. CRU instructions

### ■ ■ Replacing the keyboard

---

To replace the keyboard, do the following:

- ❶ Turn off the computer. Disconnect the AC power adapter and all cables from the computer.
- ❷ Close the computer display, and turn the computer over.
- ❸ Remove the battery pack. For details, see “Replacing the battery” on page 29.
- ❹ Remove the Hard disk drive/Memory/Central processing unit/Mini PCI Express Card slot compartment cover.
  - a. Loosen the screws that secure the compartment cover ❶.
  - b. Remove the compartment cover ❷.

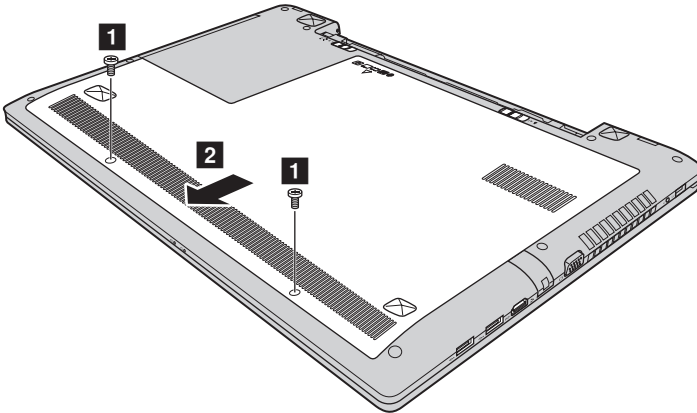

- 5 Remove the screws 3.

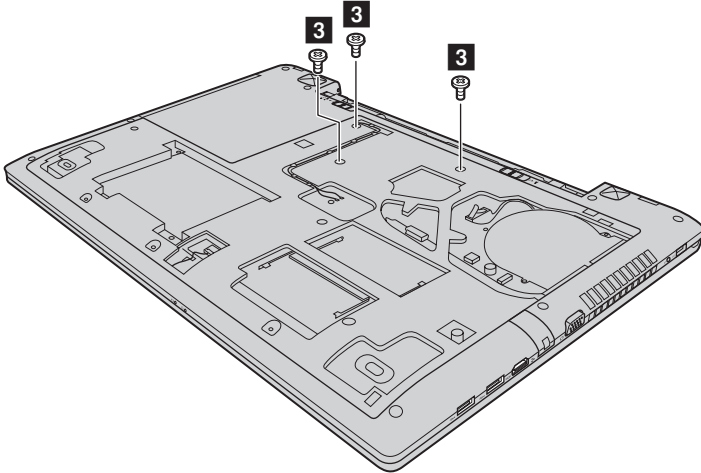

- 6 Turn the computer over, open the display, and lift the keyboard in the direction shown by arrow 4.

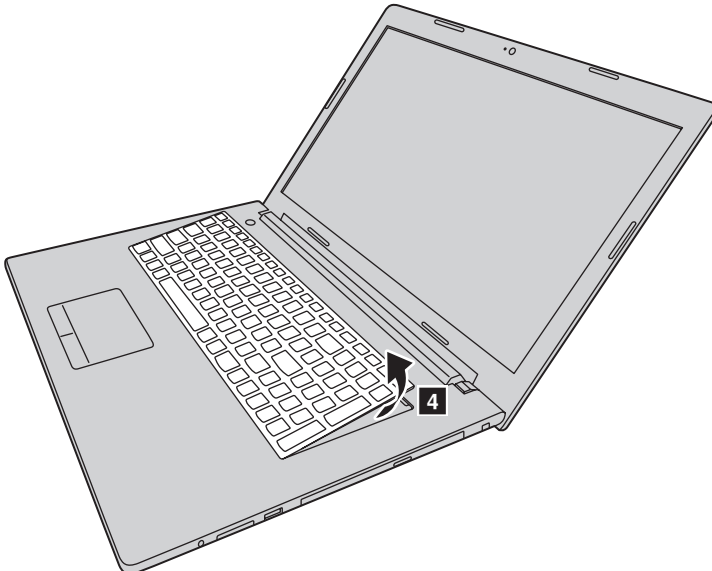

## Appendix. CRU instructions

- 7 Remove the keyboard from the keyboard bezel and turn the keyboard over.
- 8 Pull the keyboard connector slot cover upward as shown by arrow 5, and detach the keyboard cable from the keyboard connector in the direction shown by arrow 6.

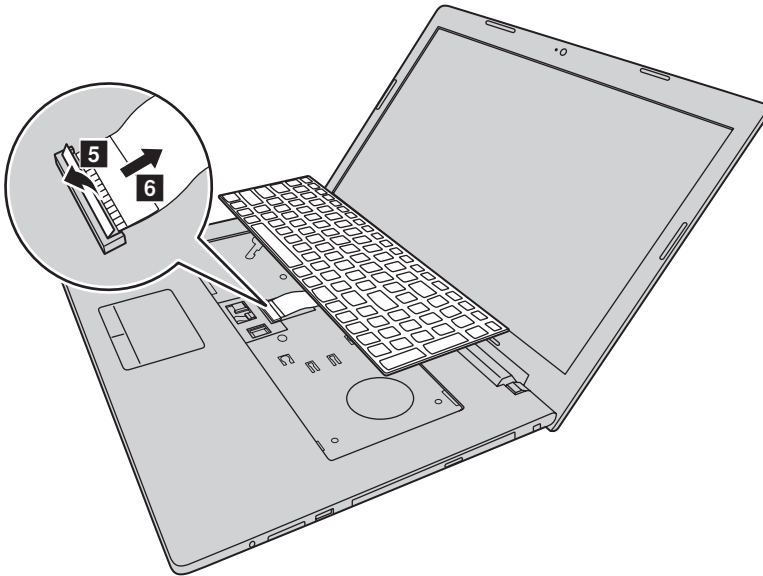

- 9 Install a new keyboard.
- 10 Connect the keyboard cable to the keyboard connector.
- 11 Press the keyboard connector slot cover downward.
- 12 Place the keyboard into the keyboard bezel, and close the computer display.
- 13 Turn the computer over, reinsert and tighten the screw.
- 14 Reinstall the compartment cover and tighten the screws.
- 15 Reinstall the battery pack.
- 16 Turn the computer over again.
- 17 Connect the AC power adapter and the cables to the computer.



## ■ ■ Removing the optical drive

---

To remove the optical drive, do the following:

- ① Turn off the computer. Disconnect the AC power adapter and all cables from the computer.
- ② Close the computer display, and turn the computer over.
- ③ Remove the battery pack. For details, see “Replacing the battery” on page 29.
- ④ Remove the Hard disk drive/Memory/Central processing unit/Mini PCI Express Card slot compartment cover.
  - a. Loosen the screws that secure the compartment cover ①.
  - b. Remove the compartment cover ②.

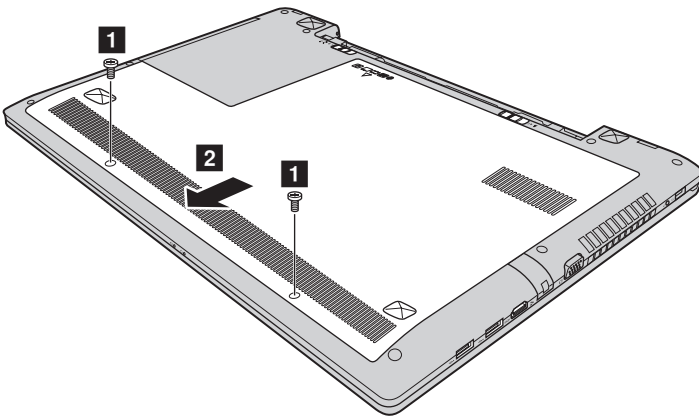

- ⑤ Remove the screw shown in the illustration ③.

## Appendix. CRU instructions

- 6 Gently pull the optical drive out 4.

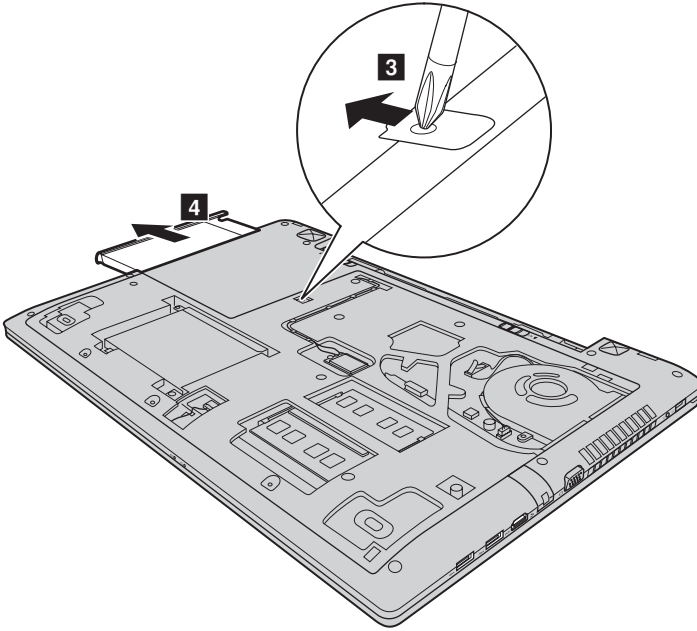

The following table provides a list of CRUs (Customer Replaceable Units) for your computer, and informs you of where to find replacement instructions.

	<b>Safety, Warranty, and Setup Guide</b>	<b>User Guide</b>
AC power adapter	○	
Power cord for AC power adapter	○	
Battery pack		○
Hard disk drive		○
Memory		○
Backup battery		○
Fan assembly		○
Keyboard		○
Optical drive		○
Mini PCI Express Card		○

# Trademarks

The following terms are trademarks or registered trademarks of Lenovo in the United States, other countries, or both.

Lenovo  
OneKey

Microsoft and Windows are trademarks of Microsoft Corporation in the United States, other countries, or both.

Other company, products, or service names may be trademarks or service marks of others.



**lenovo**