

PHILIPS

E line

241E1



www.philips.com/welcome

EN	User manual	1
	Customer care and warranty	21
	Troubleshooting & FAQs	25

Table of Contents

1. Important	1
1.1 Safety precautions and maintenance	1
1.2 Notational Descriptions	3
1.3 Disposal of product and packing material.....	4
2. Setting up the monitor.....	5
2.1 Installation	5
2.2 Operating the monitor.....	8
2.3 Remove the Base Assembly for VESA Mounting	10
3. Image Optimization	13
3.1 SmartImage	13
3.2 SmartContrast.....	14
4. Adaptive Sync	15
5. Technical Specifications	16
5.1 Resolution & Preset Modes	20
6. Power Management	21
7. Customer care and warranty ..	22
7.1 Philips' Flat Panel Monitors Pixel Defect Policy.....	22
7.2 Customer Care & Warranty.....	25
8. Troubleshooting & FAQs.....	26
8.1 Troubleshooting.....	26
8.2 General FAQs.....	27

1. Important

This electronic user's guide is intended for anyone who uses the Philips monitor. Take time to read this user's manual before you use your monitor. It contains important information and notes regarding the operation of your monitor.

The Philips guarantee applies provided the product is handled properly for its intended use, in accordance with its operating instructions and upon presentation of the original invoice or cash receipt, indicating the date of purchase, dealer's name and model and production number of the product.

1.1 Safety precautions and maintenance

Warnings

[Use of controls, adjustments or procedures other than those specified in this documentation may result in exposure to shock, electrical hazards and/or mechanical hazards.](#)

[Read and follow these instructions when connecting and using your computer monitor.](#)

Operation

- Please Keep the monitor out of direct sunlight, very strong bright lights and away from any other heat source. Lengthy exposure to this type of environment may result in discoloration and damage to the monitor.
- Remove any object that could fall into ventilation holes or prevent proper cooling of the monitor's electronics.
- Do not block the ventilation holes on the cabinet.
- When positioning the monitor, make sure the power plug and outlet are easily accessible.
- If turning off the monitor by detaching the power cable or DC power cord, wait for 6 seconds before attaching the power cable or DC power cord for normal operation.
- Please use approved power cord provided by Philips all the time. If your power cord is missing, please contact with your local service center. (Please refer to Service contact information listed in Important information manual.)
- Operate under the specified power supply. Be sure to operate the monitor only with the specified power supply. Use of an incorrect voltage will cause malfunction and may cause fire or electric shock.
- Do not disassemble the AC adapter. Disassembling the AC adapter may expose you to the danger of fire or electric shock.
- Protect the cable. Do not pull or bend the power cable and signal cable. Do not place the monitor or any other heavy objects on the cables, if damaged, the cables may cause fire or electric shock.
- Do not subject the monitor to severe vibration or high impact conditions during operation.
- Do not knock or drop the monitor during operation or transportation.
- Excessive usage of monitor can cause eye discomfort, it's better to take shorter breaks more often at your workstation than longer breaks and less often; for example a 5-10 minute break after 50-60-minute continuous screen use is likely to be better than a 15-minute break every two hours. Try to keep your eyes from eye strain while using the

i. Important

screen for a constant period of time by :

- Looking at something varying distances after a long period focusing on the screen.
- Conscious Blinking often while you work.
- Gently closing and rolling your eyes to relax.
- Reposition your screen to appropriate height and angle according to your height.
- Adjusting the brightness and contrast to appropriate level.
- Adjusting the environment lighting similar to that of your screen brightness, avoid the fluorescent lighting, and surfaces that don't reflect too much light.
- Seeing a doctor if your symptoms.

Maintenance

- To protect your monitor from possible damage, do not put excessive pressure on the LCD panel. When moving your monitor, grasp the frame to lift; do not lift the monitor by placing your hand or fingers on the LCD panel.
- Unplug the monitor if you are not going to use it for an extensive period of time.
- Unplug the monitor if you need to clean it with a slightly damp cloth. The screen may be wiped with a dry cloth when the power is off. However, never use organic solvent, such as, alcohol, or ammonia-based liquids to clean your monitor.
- To avoid the risk of shock or permanent damage to the set, do not expose the monitor to dust, rain, water, or excessive moisture environment.

- If your monitor gets wet, wipe it with dry cloth as soon as possible.
- If foreign substance or water gets in your monitor, please turn the power off immediately and disconnect the power cord. Then, remove the foreign substance or water, and send it to the maintenance center.
- Do not store or use the monitor in locations exposed to heat, direct sunlight or extreme cold.
- In order to maintain the best performance of your monitor and use it for a longer lifetime, please use the monitor in a location that falls within the following temperature and humidity ranges.
 - Temperature: 0-40°C 32-104°F
 - Humidity: 20-80% RH

Important information for Burn-in/ Ghost image

- Always activate a moving screen saver program when you leave your monitor unattended. Always activate a periodic screen refresh application if your monitor will display unchanging static content. Uninterrupted display of still or static images over an extended period may cause “burn in”, also known as “after-imaging” or “ghost imaging”, on your screen.
- “Burn-in”, “after-imaging”, or “ghost imaging” is a well-known phenomenon in LCD panel technology. In most cases, the “burned in” or “after-imaging” or “ghost imaging” will disappear gradually over a period of time after the power has been switched off.



Warning

Failure to activate a screen saver, or a periodic screen refresh application may result in severe “burn-in” or “after-image” or “ghost image” symptoms

i. Important

that will not disappear and cannot be repaired. The damage mentioned above is not covered under your warranty.

Service

- The casing cover should be opened only by qualified service personnel.
- If there is any need for any document for repair or integration, please contact with your local service center. (Please refer to Service contact information listed in Important information manual.)
- For transportation information, please refer to “Technical Specifications”.
- Do not leave your monitor in a car/trunk under direct sun light.

Note

Consult a service technician if the monitor does not operate normally, or you are not sure what procedure to take when the operating instructions given in this manual have been followed.

1.2 Notational Descriptions

The following subsections describe notational conventions used in this document.

Notes, Cautions and Warnings

Throughout this guide, blocks of text may be accompanied by an icon and printed in bold or italic type. These blocks contain notes, cautions or warnings. They are used as follows:

Note

This icon indicates important information and tips that help you make better use of your computer system.

Caution

This icon indicates information that tells you how to avoid either potential damage to hardware or loss of data.

Warning

This icon indicates the potential for bodily harm and tells you how to avoid the problem.

Some warnings may appear in alternate formats and may not be accompanied by an icon. In such cases, the specific presentation of the warning is mandated by the relevant regulatory authority.

1.3 Disposal of product and packing material

Waste Electrical and Electronic Equipment-WEEE



This marking on the product or on its packaging illustrates that, under European Directive 2012/19/EU governing used electrical and electronic appliances, this product may not be disposed of with normal household waste. You are responsible for disposal of this equipment through a designated waste electrical and electronic equipment collection. To determine the locations for dropping off such waste electrical and electronic, contact your local government office, the waste disposal organization that serves your household or the store at which you purchased the product.

Your new monitor contains materials that can be recycled and reused. Specialized companies can recycle your product to increase the amount of reusable materials and to minimize the amount to be disposed of.

All redundant packing material has been omitted. We have done our utmost to make the packaging easily separable into mono materials.

Please find out about the local regulations on how to dispose of your old monitor and packing from your sales representative.

Taking back/Recycling Information for Customers

Philips establishes technically and economically viable objectives to optimize the environmental performance of the organization's product, service and activities.

From the planning, design and production stages, Philips emphasizes the important of making products that can easily be recycled. At Philips, end-of-life management primarily entails participation in national take-back initiatives and recycling programs whenever possible, preferably in cooperation with competitors, which recycle all materials (products and related packaging material) in accordance with all Environmental Laws and taking back program with the contractor company.

Your display is manufactured with high quality materials and components which can be recycled and reused.

To learn more about our recycling program please visit

<http://www.philips.com/a-w/about/sustainability.html>

2. Setting up the monitor

2.1 Installation

1 Package contents

241E1SC

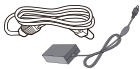
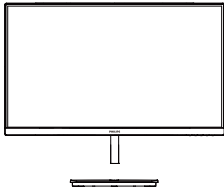

AC/DC Adapter



* CD

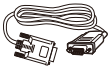

* VGA

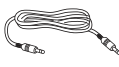

* Audio cable

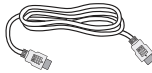

* HDMI

241E1C

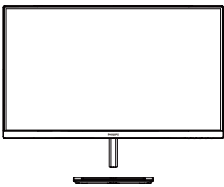

AC/DC Adapter



* CD



* VGA

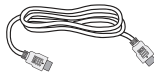

* HDMI

* Different according to region.

Note

Use only the AC/DC adapter model: Philips ADPC1938EX.

2 Install base stand

241E1SC

1. In order to well protect this monitor and avoid scratching or damaging of the monitor, keep the monitor face down in the cushion for the base installation.

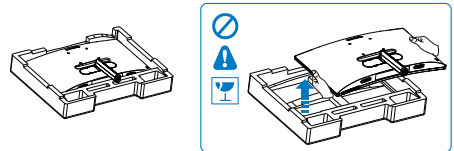

2. (1) Hold the base stand with both hands and firmly insert the base stand into the base column.
(2) Use your fingers to tighten the screw located at the bottom of the base.
(3) Use screwdriver to tighten the screw located at the bottom of the base, and secure the base to the column tightly.

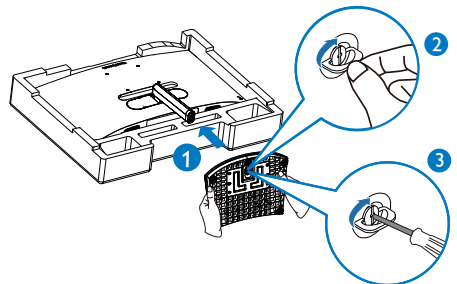

3. After attaching the base, erect the monitor with both hands on holding the monitor together with styrofoam firmly. Now you can pull out the styrofoam. Notice this monitor is

2. Setting up the monitor

curved design, when you pull out the styrofoam, do not squeeze the panel to avoid broken panel.

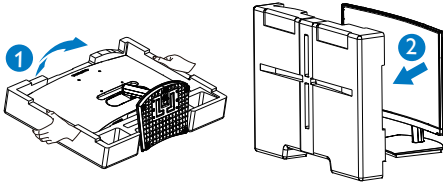

241E1C

1. In order to well protect this monitor and avoid scratching or damaging of the monitor, keep the monitor face down in the cushion for the base installation.

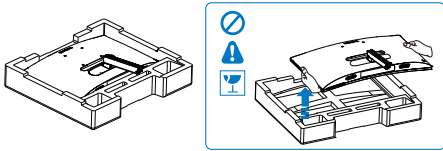

2. (1) Hold the base stand with both hands and firmly insert the base stand into the base column.
(2) Use screwdriver to tighten the screw located at the bottom of the base, and secure the base to the column tightly.

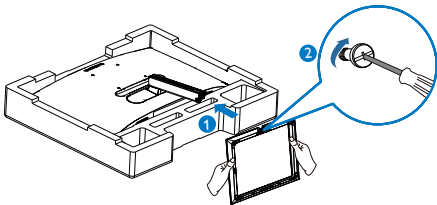

3. After attaching the base, erect the monitor with both hands on holding the monitor together with styrofoam firmly. Now you can pull out the styrofoam. Notice this monitor is curved design, when you pull out the styrofoam, do not squeeze the panel to avoid broken panel.

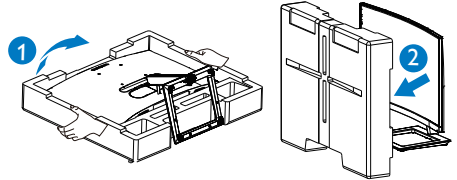

⚠ Warning:

This product is curve design, when attach / detach the base, place the protective material under the monitor and do not press down the monitor to avoid the damage.

2. Setting up the monitor

3 Connecting to your PC

241E1SC/241E1C

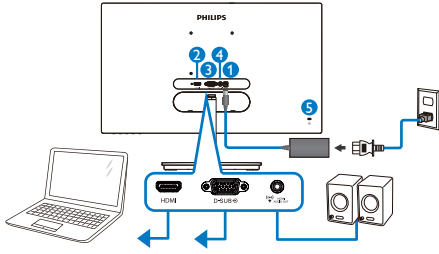

- 1 AC/DC power input
- 2 HDMI input
- 3 VGA input
- 4 HDMI audio out
- 5 Kensington anti-theft lock

241E1SCA

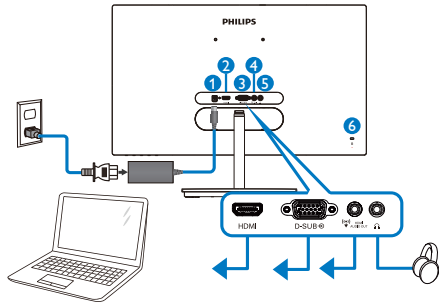

- 1 AC/DC power input
- 2 HDMI input
- 3 VGA input
- 4 HDMI audio out
- 5 Earphone jack
- 6 Kensington anti-theft lock

Connect to PC

1. Connect the power cord to the back of the monitor firmly.
2. Turn off your computer and unplug its power cable.
3. Connect the monitor signal cable to the video connector on the back of your computer.
4. Plug the power cord of your computer and your monitor into a nearby outlet.
5. Turn on your computer and monitor. If the monitor displays an image, installation is complete.

2.2 Operating the monitor

1 Front view product description

241E1SC/241E1C

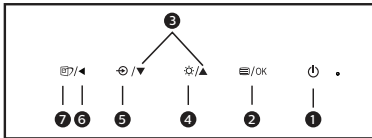
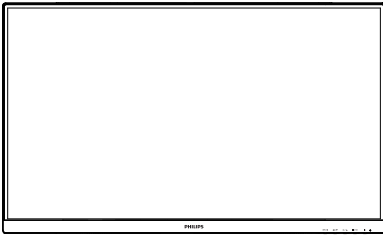

1		Switch monitor's power ON and OFF.
2		Access the OSD menu. Confirm the OSD adjustment.
3		Adjust the OSD menu.
4		Adjust the brightness level.
5		Change the signal input source.
6		Return to previous OSD level.
7		SmartImage. There are multiple selections: FPS, Racing, RTS, Gamer 1, Gamer 2, LowBlue Mode and Off.

241E1SCA

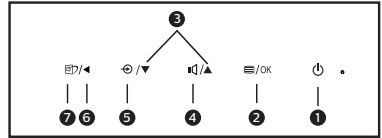
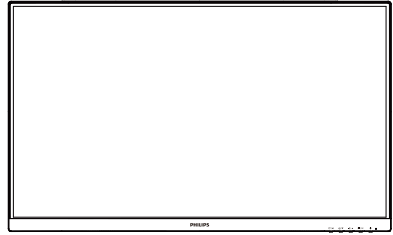

1		Switch monitor's power ON and OFF.
2		Access the OSD menu. Confirm the OSD adjustment.
3		Adjust the OSD menu.
4		Adjust the speaker volume.
5		Change the signal input source.
6		Return to previous OSD level.
7		SmartImage. There are multiple selections: FPS, Racing, RTS, Gamer 1, Gamer 2, LowBlue Mode and Off.

2. Setting up the monitor

2 Description of the On Screen Display

What is On-Screen Display (OSD)?

On-Screen Display (OSD) is a feature in all Philips LCD monitors. It allows an end user to adjust screen performance or select functions of the monitors directly through an on-screen instruction window. A user friendly on screen display interface is shown as below:

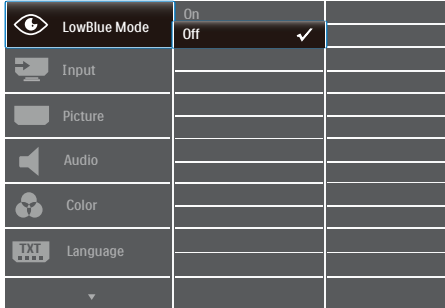

Basic and simple instruction on the control keys

To access the OSD menu on this Philips Display simply use the single toggle button on the backside of the Display bezel. The single button operates like a joystick. To move the cursor, simply toggle the button in four directions. Press the button to select desired option.

The OSD Menu

Below is an overall view of the structure of the On-Screen Display. You can use this as a reference when you want to work your way around the different adjustments later on.

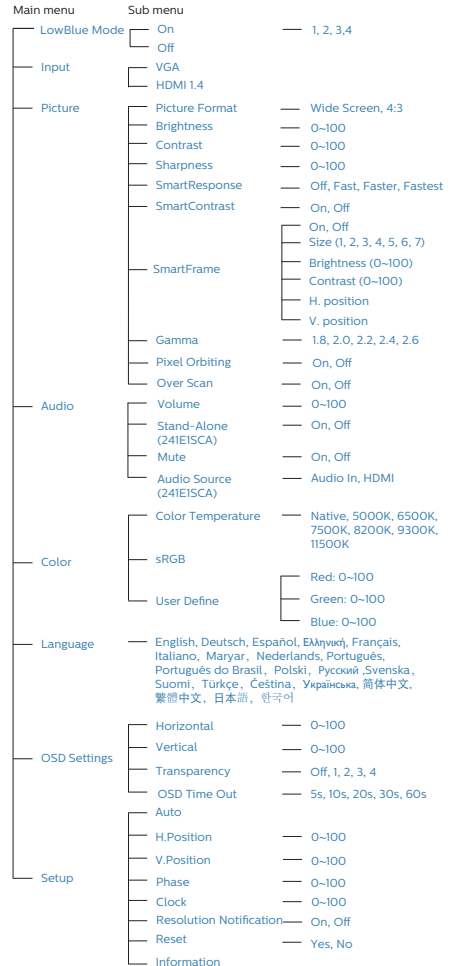

2. Setting up the monitor

3 Resolution notification

This monitor is designed for optimal performance at its native resolution, 1920×1080@60Hz. When the monitor is powered on at a different resolution, an alert is displayed on screen: Use 1920×1080 for best results.

Display of the native resolution alert can be switched off from Setup in the OSD (On Screen Display) menu.

4 Physical Function

Tilt

241E1SC

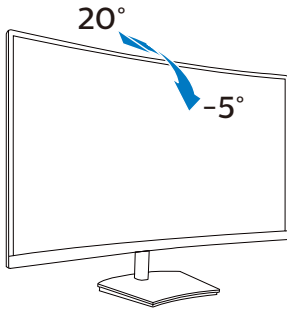

241E1C

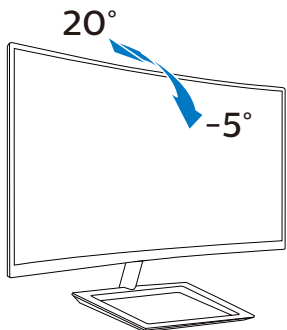

2.3 Remove the Base Assembly for VESA Mounting

Before you start disassembling the monitor base, please follow the instructions below to avoid any possible damage or injury.

241E1SC

1. Place the display face down on a smooth surface. Pay attention not to scratch or damage the screen.

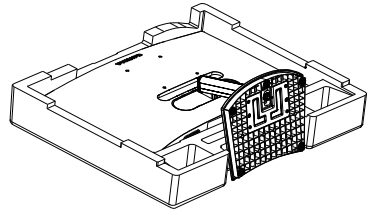

2. (1) Use screwdriver to loosen the screw located at the bottom of the base.
(2) Use your fingers to loosen the screw located at the bottom of the base, and remove the base from the stand.

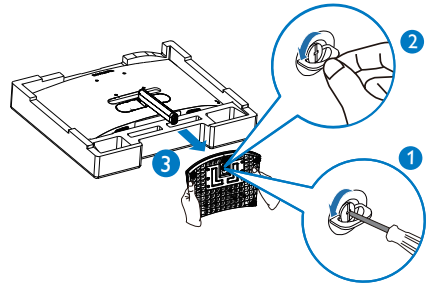

2. Setting up the monitor

3. Remove the hinge cover from monitor body by using your fingers.

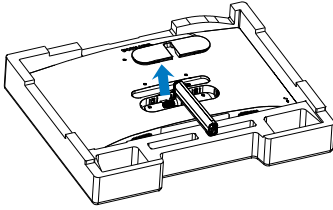

4. Use a screwdriver to remove the screws on the arm, and then detach the arm/stand from the monitor.

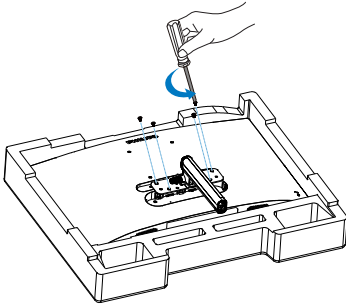

Note

This monitor accepts a 100mm x 100mm VESA-Compliant mounting interface. VESA Mounting Screw M4. Always contact manufacturer for wall-mount installation.

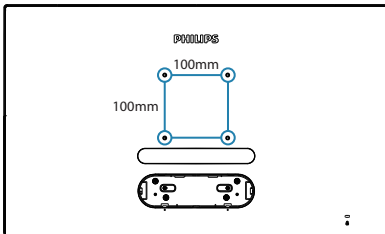

241E1C

1. Place the display face down on a smooth surface. Pay attention not to scratch or damage the screen.

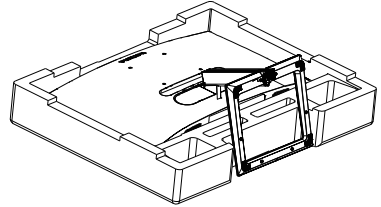

2. Use screwdriver to loosen the screw located at the bottom of the base, and remove the base from the stand.

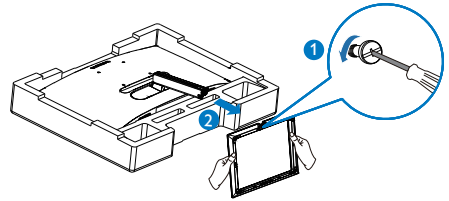

3. Remove the hinge cover from monitor body by using your fingers.

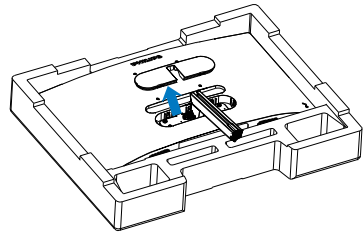

3. Image Optimization

3.1 SmartImage

1 What is it?

SmartImage provides presets that optimize display for different types of content, dynamically adjusting brightness, contrast, color and sharpness in real time. Whether you're working with text applications, displaying images or watching a video, Philips SmartImage delivers great optimized monitor performance.

2 Why do I need it?

You want a monitor that delivers optimized display all your favorite types of content, SmartImage software dynamically adjust brightness, contrast, color and sharpness in real time to enhance your monitor viewing experience.

3 How does it work?

SmartImage is an exclusive, leading edge Philips technology that analyzes the content displayed on your screen. Based on a scenario you select, SmartImage dynamically enhances the contrast, color saturation and sharpness of images to enhance the contents being displayed - all in real time with the press of a single button.

4 How to enable SmartImage?

241E1SC

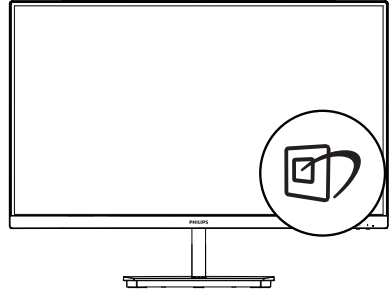

241E1C

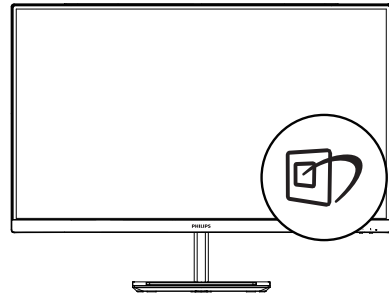

1. Toggle to the left to launch the SmartImage on screen display.
2. Toggle to the up or down to select between FPS, Racing, RTS, Gamer 1, Gamer 2, LowBlue Mode and Off.
3. The SmartImage on screen display will remain on screen for 5 seconds or you can also toggle to the left to make confirmation.

There are multiple selections: FPS, Racing, RTS, Gamer 1, Gamer 2, LowBlue Mode and Off.

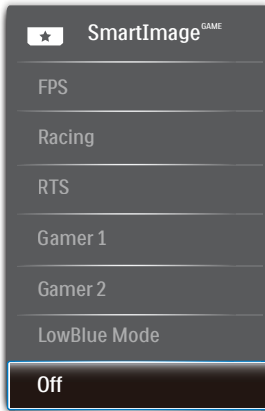

- **FPS:** For playing FPS (First Person Shooters) games. Improves dark theme black level details.
- **Racing:** For playing Racing games. Provides fastest response time and high color saturation.
- **RTS:** For playing RTS (Real Time Strategy) games, a user-selected portion can be highlighted for RTS games (through SmartFrame). The picture quality can be adjusted for the highlighted portion.
- **Gamer 1:** User's preference settings saved as Gamer 1.
- **Gamer 2:** User's preference settings saved as Gamer 2.
- **LowBlue Mode:** LowBlue Mode for easy on-the-eyes productivity. Studies have shown that just as ultra-violet rays can cause eye damage, shortwave length blue light rays from LED displays can cause eye damage and affect vision over time. Developed for wellbeing, Philips LowBlue Mode setting uses a smart software technology to reduce harmful shortwave blue light.
- **Off:** No optimization by SmartImage.

3.2 SmartContrast

1 What is it?

Unique technology that dynamically analyzes displayed content and automatically optimizes a LCD monitor's contrast ratio for maximum visual clarity and viewing enjoyment, stepping up backlighting for clearer, crisper and brighter images or dimming backlighting for clear display of images on dark backgrounds.

2 Why do I need it?

You want the very best visual clarity and viewing comfort for every type of content. SmartContrast dynamically controls contrast and adjusts backlighting for clear, crisp, bright gaming and video images or displays clear, readable text for office work. By reducing your monitor's power consumption, you save on energy costs and extend the lifetime of your monitor.

3 How does it work?

When you activate SmartContrast, it will analyse the content you are displaying in real time to adjust colors and control backlight intensity. This function will dynamically enhance contrast for a great entertainment experience when viewing videos or playing games.

4. Adaptive Sync



Adaptive Sync

PC gaming has long been an imperfect experience because GPUs and monitors update at different rates. Sometimes a GPU can render many new pictures during a single update of the monitor, and the monitor will show pieces of each picture as a single image. This is called “tearing.” Gamers can fix tearing with a feature called “v-sync,” but the image can become jerky as the GPU waits on the monitor to call for an update before delivering new pictures.

The responsiveness of mouse input and overall frames per second are reduced with v-sync, too. AMD Adaptive Sync™ technology eliminates all of these problems by letting the GPU update the monitor the moment a new picture is ready, leaving gamers with unbelievably smooth, responsive, tearing-free games.

Followed by the graphic card that are compatible.

- AMD Radeon R9 285
- AMD Radeon R7 260X
- AMD Radeon R7 260
- Processor A-Series Desktop and Mobility APUs
 - AMD A10-7890K
 - AMD A10-7870K
 - AMD A10-7850K
 - AMD A10-7800
 - AMD A10-7700K
 - AMD A8-7670K
 - AMD A8-7650K
 - AMD A8-7600
 - AMD A6-7400K

- Operating system
 - Windows 10/8.1/8/7
- Graphic Card: R9 290/300 Series & R7 260 Series
 - AMD Radeon R9 300 Series
 - AMD Radeon R9 Fury X
 - AMD Radeon R9 360
 - AMD Radeon R7 360
 - AMD Radeon R9 295X2
 - AMD Radeon R9 290X
 - AMD Radeon R9 290

5. Technical Specifications

Picture/Display	
Monitor Panel Type	VA
Backlight	W-LED system
Panel Size	23.8" W (60.5 cm)
Aspect Ratio	16:9
Pixel Pitch	0.311 x 0.311 mm
Contrast Ratio (typ.)	3000:1
Optimum Resolution	1920 x 1080 @ 60Hz
Viewing Angle	178° (H) / 178° (V) @ C/R > 10 (typ.)
Picture Enhancement	SmartImage
Flicker free	Yes
Display Colors	16.7M
Vertical Refresh Rate	50Hz-76Hz (Analog) 48Hz-76Hz (HDMI, Adaptive Sync for HDMI)
Horizontal Frequency	30KHz-83KHz (Analog) 30KHz-85KHz (HDMI, Adaptive Sync for HDMI)
sRGB	Yes
LowBlue Mode	Yes
Adaptive Sync	Yes
Connectivity	
Signal Input	VGA (Analog), HDMI (Digital, HDCP)
Audio In/Out	241E1SC/241E1C: HDMI audio out 241E1SCA: HDMI audio out, headphone out
Input Signal	Separate Sync, Sync on Green
Convenience	
OSD Languages	English, German, Spanish, Greek, French, Italian, Hungarian, Dutch, Portuguese, Brazil Portuguese, Polish, Russian, Swedish, Finnish, Turkish, Czech, Ukrainian, Simplified Chinese, Traditional Chinese, Japanese, Korean
Other Convenience	Kensington Lock, VESA mount (100 x 100mm)
Plug & Play Compatibility	DDC/CI, Mac OSX, sRGB, Windows 10/8.1/8/7
Stand	
Tilt	-5° / +20°

5. Technical Specifications

Power(241E1C/241E1SC)			
Consumption	AC Input Voltage at 100VAC , 50Hz	AC Input Voltage at 115VAC , 60Hz	AC Input Voltage at 230VAC , 50Hz
Normal Operation	27.8 W (typ.)	27.9 W (typ.)	28.0 W (typ.)
Sleep (Standby)	<0.5 W (typ.)	<0.5 W (typ.)	<0.5 W (typ.)
Off	<0.3 W (typ.)	<0.3 W (typ.)	<0.3 W (typ.)
Heat Dissipation*	AC Input Voltage at 100VAC , 50Hz	AC Input Voltage at 115VAC , 60Hz	AC Input Voltage at 230VAC , 50Hz
Normal Operation	94.88 BTU/hr (typ.)	95.22 BTU/hr (typ.)	95.56 BTU/hr (typ.)
Sleep (Standby)	<1.71 BTU/hr (typ.)	<1.71 BTU/hr (typ.)	<1.71 BTU/hr (typ.)
Off	<1.02 BTU/hr (typ.)	<1.02 BTU/hr (typ.)	<1.02 BTU/hr (typ.)
Power LED indicator	On mode: White, Standby/Sleep mode: White (blinking)		
Power Supply	External, 100-240VAC, 50-60Hz		

Power(241E1SCA)			
Consumption	AC Input Voltage at 100VAC , 50Hz	AC Input Voltage at 115VAC , 60Hz	AC Input Voltage at 230VAC , 50Hz
Normal Operation	27.8 W (typ.)	27.9 W (typ.)	28.0 W (typ.)
Sleep (Standby)	<0.5 W (typ.)	<0.5 W (typ.)	<0.5 W (typ.)
Off	<0.3 W (typ.)	<0.3 W (typ.)	<0.3 W (typ.)
Heat Dissipation*	AC Input Voltage at 100VAC , 50Hz	AC Input Voltage at 115VAC , 60Hz	AC Input Voltage at 230VAC , 50Hz
Normal Operation	94.88 BTU/hr (typ.)	95.22 BTU/hr (typ.)	95.56 BTU/hr (typ.)
Sleep (Standby)	<1.71 BTU/hr (typ.)	<1.71 BTU/hr (typ.)	<1.71 BTU/hr (typ.)
Off	<1.02 BTU/hr (typ.)	<1.02 BTU/hr (typ.)	<1.02 BTU/hr (typ.)
Power LED indicator	On mode: White, Standby/Sleep mode: White (blinking)		
Power Supply	External, 100-240VAC, 50-60Hz		

Dimension	
Product with stand (WxHxD)	611 x 462 x 202 mm (241E1SC/241E1SCA) 611 x 462 x 203 mm (241E1C)
Product without stand (WxHxD)	611 x 367 x 43 mm
Product with packaging (WxHxD)	730 x 524 x 160 mm (241E1SC/241E1SCA) 730 x 538 x 186 mm (241E1C)

5. Technical Specifications

Weight	
Product with stand	4.42 kg (241E1SC) 4.33 kg (241E1C) 4.50 kg (241E1SCA)
Product without stand	3.73 kg (241E1SC/241E1C) 3.81 kg (241E1SCA)
Product with packaging	6.47 kg (241E1SC) 6.63 kg (241E1C) 6.70 kg (241E1SCA)
Operating Condition	
Temperature range (operation)	0°C to 40 °C
Relative humidity (operation)	20% to 80%
Atmospheric pressure (operation)	700 to 1060hPa
Temperature range (Non-operation)	-20°C to 60°C
Relative humidity (Non-operation)	10% to 90%
Atmospheric pressure (Non-operation)	500 to 1060hPa
Environmental	
ROHS	YES
Packaging	100% recyclable
Specific Substances	100% PVC BFR free housing
Compliance and standards	
Regulatory Approvals	241E1SC/241E1C: CCC, CECP, CU-EAC, ISO9241-307, RCM, CE, CEL, BAUART 241E1SCA: CU-EAC, ISO9241-307, BAUART, CE, RCM
Cabinet	
Color	White/Black
Finish	Texture

Note

This data is subject to change without notice. Go to www.philips.com/support to download the latest version of leaflet.

5.1 Resolution & Preset Modes

1 Maximum Resolution

1920x1080@60Hz (analog input)

1920x1080@75Hz (HDMI input)

2 Recommended Resolution

1920x1080@60Hz

H. freq (kHz)	Resolution	V. freq (Hz)
31.47	720x400	70.09
31.47	640x480	59.94
35.00	640x480	66.67
37.86	640x480	72.81
37.50	640x480	75.00
37.88	800x600	60.32
46.88	800x600	75.00
48.36	1024x768	60.00
60.02	1024x768	75.03
63.89	1280x1024	60.02
79.98	1280x1024	75.03
55.94	1440x900	59.89
70.64	1440x900	74.98
65.29	1680x1050	59.95
67.50	1920x1080	60.00
83.89	1920x1080	74.97

Note

Please notice that your display works best at native resolution of 1920x1080@60Hz. For best display quality, please follow this resolution recommendation.

6. Power Management

If you have VESA DPM compliance display card or software installed in your PC, the monitor can automatically reduce its power consumption when not in use. If an input from a keyboard, mouse or other input device is detected, the monitor will 'wake up' automatically. The following table shows the power consumption and signaling of this automatic power saving feature:

241E1C/241E1SC

Power Management Definition					
VESA Mode	Video	H-sync	V-sync	Power Used	LED Color
Active	ON	Yes	Yes	27.9 W (typ.) 33.5 W(Max.)	White
Sleep	OFF	No	No	0.5 W (typ.)	White (blink)
Off	OFF	-	-	0.3 W (typ.)	OFF

241E1SCA

Power Management Definition					
VESA Mode	Video	H-sync	V-sync	Power Used	LED Color
Active	ON	Yes	Yes	27.9 W (typ.) 33.5 W(Max.)	White
Sleep	OFF	No	No	0.5 W (typ.)	White (blink)
Off	OFF	-	-	0.3 W (typ.)	OFF

The following setup is used to measure power consumption on this monitor.

- Native resolution: 1920x1080
- Contrast: 50%
- Brightness: 90%
- Color temperature: 6500k with full white pattern

Note

This data is subject to change without notice.

7. Customer care and warranty

7.1 Philips' Flat Panel Monitors Pixel Defect Policy

Philips strives to deliver the highest quality products. We use some of the industry's most advanced manufacturing processes and practice stringent quality control. However, pixel or sub pixel defects on the TFT Monitor panels used in flat panel monitors are sometimes unavoidable. No manufacturer can guarantee that all panels will be free from pixel defects, but Philips guarantees that any monitor with an unacceptable number of defects will be repaired or replaced under warranty. This notice explains the different types of pixel defects and defines acceptable defect levels for each type. In order to qualify for repair or replacement under warranty, the number of pixel defects on a TFT Monitor panel must exceed these acceptable levels. For example, no more than 0.0004% of the sub pixels on a monitor may be defective. Furthermore, Philips sets even higher quality standards for certain types or combinations of pixel defects that are more noticeable than others. This policy is valid worldwide.

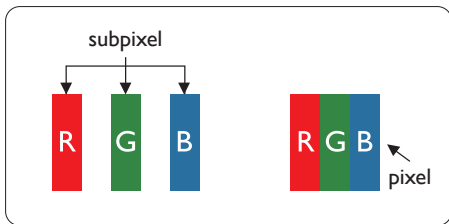

Pixels and Sub pixels

A pixel, or picture element, is composed of three sub pixels in the primary colors of red, green and blue. Many pixels

together form an image. When all sub pixels of a pixel are lit, the three colored sub pixels together appear as a single white pixel. When all are dark, the three colored sub pixels together appear as a single black pixel. Other combinations of lit and dark sub pixels appear as single pixels of other colors.

Types of Pixel Defects

Pixel and sub pixel defects appear on the screen in different ways. There are two categories of pixel defects and several types of sub pixel defects within each category.

Bright Dot Defects

Bright dot defects appear as pixels or sub pixels that are always lit or 'on'. That is, a bright dot is a sub-pixel that stands out on the screen when the monitor displays a dark pattern. There are the types of bright dot defects.

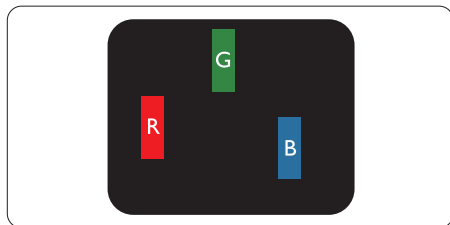

One lit red, green or blue sub pixel.

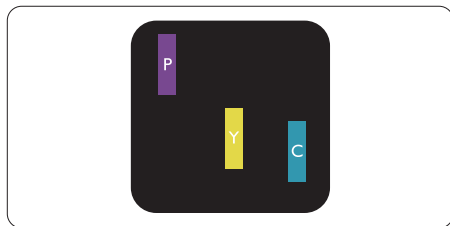

Two adjacent lit sub pixels:

- Red + Blue = Purple
- Red + Green = Yellow
- Green + Blue = Cyan (Light Blue)

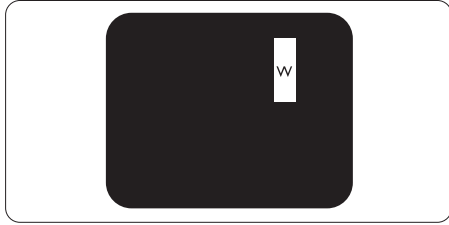

Three adjacent lit sub pixels (one white pixel).

Note

A red or blue bright dot must be more than 50 percent brighter than neighboring dots while a green bright dot is 30 percent brighter than neighboring dots.

Black Dot Defects

Black dot defects appear as pixels or sub pixels that are always dark or 'off'. That is, a dark dot is a sub-pixel that stands out on the screen when the monitor displays a light pattern. These are the types of black dot defects.

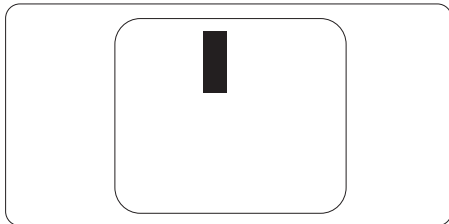

Proximity of Pixel Defects

Because pixel and sub pixels defects of the same type that are near to one another may be more noticeable, Philips also specifies tolerances for the proximity of pixel defects.

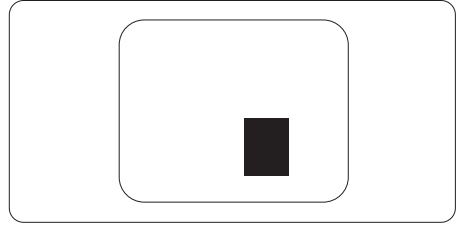

Pixel Defect Tolerances

In order to qualify for repair or replacement due to pixel defects during the warranty period, a TFT Monitor panel in a Philips flat panel monitor must have pixel or sub pixel defects exceeding the tolerances listed in the following tables.

7. Customer care and warranty

BRIGHT DOT DEFECTS	ACCEPTABLE LEVEL
1 lit subpixel	3
2 adjacent lit subpixels	1
3 adjacent lit subpixels (one white pixel)	0
Distance between two bright dot defects*	>15mm
Total bright dot defects of all types	3

BLACK DOT DEFECTS	ACCEPTABLE LEVEL
1 dark subpixel	5 or fewer
2 adjacent dark subpixels	2 or fewer
3 adjacent dark subpixels	0
Distance between two black dot defects*	>15mm
Total black dot defects of all types	5 or fewer

TOTAL DOT DEFECTS	ACCEPTABLE LEVEL
Total bright or black dot defects of all types	5 or fewer

Note

1 or 2 adjacent sub pixel defects = 1 dot defect

7.2 Customer Care & Warranty

For warranty coverage information and additional support requirements valid for your region, please visit www.philips.com/support website for details or contact your local Philips Customer Care Center.

For extended warranty, if you would like to extend your general warranty period, an Out of Warranty service package is offered via our Certified Service Center.

If you wish to make use of this service, please be sure to purchase the service within 30 calendar days of your original purchase date. During the extended warranty period, the service includes pickup, repair and return service, however the user will be responsible for all costs accrued.

If the Certified Service Partner cannot perform the required repairs under the offered extended warranty package, we will find alternative solutions for you, if possible, up to the extended warranty period you have purchased.

Please contact our Philips Customer Service Representative or local contact center (by Consumer care number) for more details.

Philips Customer Care Center number listed below.

Local Standard Warranty Period	Extended Warranty Period	Total Warranty Period
Depend on different Regions	+ 1 Year	Local Standard warranty period +1
	+ 2 Years	Local Standard warranty period +2
	+ 3 Years	Local Standard warranty period +3

**Proof of original purchase and extended warranty purchase required.

Note

1. Please refer to important information manual for regional service hotline, which is available on the Philips website support page.
2. Spare parts are available for use in the repair of the product for minimum three-year from your original purchase date or 1 year after the end of production, whichever is longer.

8. Troubleshooting & FAQs

8.1 Troubleshooting

This page deals with problems that can be corrected by a user. If the problem still persists after you have tried these solutions, contact Philips customer service representative.

1 Common Problems

No Picture (Power LED not lit)

- Make sure the power cord is plugged into the power outlet and into the back of the monitor.
- First, ensure that the power button on the front of the monitor is in the OFF position, then press it to the ON position.

No Picture (Power LED is White)

- Make sure the computer is turned on.
- Make sure the signal cable is properly connected to your computer.
- Make sure the monitor cable has no bent pins on the connect side. If yes, repair or replace the cable.
- The Energy Saving feature may be activated

Screen says

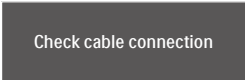

Check cable connection

- Make sure the monitor cable is properly connected to your computer. (Also refer to the Quick Start Guide).

- Check to see if the monitor cable has bent pins.
- Make sure the computer is turned on.

AUTO button doesn't function

- The auto function is applicable only in VGA-Analog mode. If the result is not satisfactory, you can do manual adjustments via the OSD menu.

ⓘ Note

The Auto Function is not applicable in DVI-Digital mode as it is not necessary.

Visible signs of smoke or sparks

- Do not perform any troubleshooting steps
- Disconnect the monitor from mains power source immediately for safety
- Contact with Philips customer service representative immediately.

2 Imaging Problems

Image is not centered

- Adjust the image position using the “Auto” function in OSD Main Controls.
- Adjust the image position using the Phase/Clock of Setup in OSD Main Controls. It is valid only in VGA mode.

Image vibrates on the screen

- Check that the signal cable is properly securely connected to the graphics board or PC.

Vertical flicker appears



- Adjust the image using the “Auto” function in OSD Main Controls.
- Eliminate the vertical bars using the Phase/Clock of Setup in OSD

8. Troubleshooting & FAQs

Main Controls. It is valid only in VGA mode.

Horizontal flicker appears



- Adjust the image using the “Auto” function in OSD Main Controls.
- Eliminate the vertical bars using the Phase/Clock of Setup in OSD Main Controls. It is valid only in VGA mode.

Image appears blurred, indistinct or too dark

- Adjust the contrast and brightness on On-Screen Display.

An “after-image”, “burn-in” or “ghost image” remains after the power has been turned off.

- Uninterrupted display of still or static images over an extended period may cause “burn in”, also known as “after-imaging” or “ghost imaging”, on your screen. “Burn-in”, “after-imaging”, or “ghost imaging” is a well-known phenomenon in LCD panel technology. In most cases, the “burned in” or “after-imaging” or “ghost imaging” will disappear gradually over a period of time after the power has been switched off.
- Always activate a moving screen saver program when you leave your monitor unattended.
- Always activate a periodic screen refresh application if your LCD monitor will display unchanging static content.
- Failure to activate a screen saver, or a periodic screen refresh application may result in severe “burn-in” or “after-image” or “ghost image” symptoms that will not disappear

and cannot be repaired. The damage mentioned above is not covered under your warranty.

Image appears distorted. Text is fuzzy or blurred.

- Set the PC’s display resolution to the same mode as monitor’s recommended screen native resolution.

Green, red, blue, dark, and white dots appears on the screen

- The remaining dots are normal characteristic of the liquid crystal used in today’s technology, Please refer the pixel policy for more detail.

* The “power on” light is too strong and is disturbing

- You can adjust “power on” light using the power LED Setup in OSD main Controls.

For further assistance, refer to the Service contact information listed in Important information manual and contact Philips customer service representative.

* [Functionality different according to display.](#)

8.2 General FAQs

Q1: When I install my monitor what should I do if the screen shows 'Cannot display this video mode'?

Ans.: Recommended resolution for this monitor: 1920x1080@60Hz.

- Unplug all cables, then connect your PC to the monitor that you used previously.
- In the Windows Start Menu, select Settings/Control Panel. In the Control Panel Window, select the Display icon. Inside the Display Control Panel, select the 'Settings' tab. Under the setting tab, in box

8. Troubleshooting & FAQs

labelled 'desktop area', move the sidebar to 1920x1080 pixels.

- Open 'Advanced Properties' and set the Refresh Rate to 60Hz, then click OK.
- Restart your computer and repeat step 2 and 3 to verify that your PC is set at 1920x1080@60Hz.
- Shut down your computer, disconnect your old monitor and reconnect your Philips LCD monitor.
- Turn on your monitor and then turn on your PC.

Q2: What is the recommended refresh rate for LCD monitor?

Ans.: Recommended refresh rate in LCD monitors is 60Hz, In case of any disturbance on screen, you can set it up to 75Hz to see if that removes the disturbance.

Q3: What are the .inf and .icm files on the CD-ROM? How do I install the drivers (.inf and .icm)?

Ans.: These are the driver files for your monitor. Follow the instructions in your user manual to install the drivers. Your computer may ask you for monitor drivers (.inf and .icm files) or a driver disk when you first install your monitor. Follow the instructions to insert the companion CD-ROM included in this package. Monitor drivers (.inf and .icm files) will be installed automatically.

Q4: How do I adjust the resolution?

Ans.: Your video card/graphic driver and monitor together determine the available resolutions. You can select the desired resolution under Windows® Control Panel with the "Display properties".

Q5: What if I get lost when I am making monitor adjustments via OSD?

Ans.: Simply press the OK button, then select 'Reset' to recall all of the original factory settings.

Q6: Is the LCD screen resistant to scratches?

Ans.: In general it is recommended that the panel surface is not subjected to excessive shocks and is protected from sharp or blunt objects. When handling the monitor, make sure that there is no pressure or force applied to the panel surface side. This may affect your warranty conditions.

Q7: How should I clean the LCD surface?

Ans.: For normal cleaning, use a clean, soft cloth. For extensive cleaning, please use isopropyl alcohol. Do not use other solvents such as ethyl alcohol, ethanol, acetone, hexane, etc.

Q8: Can I change the color setting of my monitor?

Ans.: Yes, you can change your color setting through OSD control as the following procedures,

- Press "OK" to show the OSD (On Screen Display) menu
- Press "Down Arrow" to select the option "Color" then press "OK" to enter color setting, there are three settings as below.
 1. Color Temperature; With settings in the 6500K range the panel appears "warm, with a red-white color tone", while a 9300K temperature yields "cool, blue-white toning".
 2. sRGB; this is a standard setting for ensuring correct exchange of colors between different device

(e.g. digital cameras, monitors, printers, scanners, etc)

3. User Define; the user can choose his/her preference color setting by adjusting red, green blue color.

 **Note**

A measurement of the color of light radiated by an object while it is being heated. This measurement is expressed in terms of absolute scale, (degrees Kelvin). Lower Kelvin temperatures such as 2004K are red; higher temperatures such as 9300K are blue. Neutral temperature is white, at 6504K.

Q9: Can I connect my LCD monitor to any PC, workstation or Mac?

Ans.: Yes. All Philips LCD monitors are fully compatible with standard PCs, Macs and workstations. You may need a cable adapter to connect the monitor to your Mac system. Please contact your Philips sales representative for more information.

Q10: Are Philips LCD monitors Plug-and- Play?

Ans.: Yes, the monitors are Plug-and-Play compatible with Windows 10/8.1/8/7, Mac OSX.

Q11: What is Image Sticking, or Image Burn-in, or After Image, or Ghost Image in LCD panels?

Ans.: Uninterrupted display of still or static images over an extended period may cause "burn in", also known as "after-imaging" or "ghost imaging", on your screen. "Burn-in", "after-imaging", or "ghost imaging" is a well-known phenomenon in LCD panel technology. In most cases, the "burned in" or "after-imaging" or "ghost imaging" will disappear

gradually over a period of time after the power has been switched off.

Always activate a moving screen saver program when you leave your monitor unattended.

Always activate a periodic screen refresh application if your LCD monitor will display unchanging static content.

 **Warning**

Severe "burn-in" or "after-image" or "ghost image" symptoms will not disappear and cannot be repaired. The damage mentioned above is not covered under your warranty.

Q12: Why is my Display not showing sharp text, and is displaying jagged characters?

Ans.: Your LCD monitor works best at its native resolution of 1920x1080@60Hz. For best display, please use this resolution.

Q13: How to unlock/lock my hot key?

Ans.: Please press /OK for 10 seconds to unlock/lock the hot key, by doing so, your monitor pops out "Attention" to show the unlock/lock status as shown below illustrators.

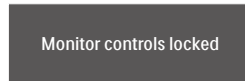
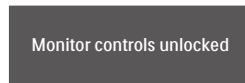



2019 © TOP Victory Investment Ltd. All rights reserved.

This product has been manufactured by and is sold under the responsibility of Top Victory Investments Ltd., and Top Victory Investments Ltd. is the warrantor in relation to this product. Philips and the Philips Shield Emblem are registered trademarks of Koninklijke Philips N.V. and are used under license.

Specifications are subject to change without notice.

Version: M1241ECEQ1T