

Lenovo ideapad 310

ideapad 310-14ISK

ideapad 310-15ISK

ideapad 310 Touch-15ISK

User Guide



Read the safety notices and important tips in the included manuals before using your computer.

Lenovo™

Notes

- Before using the product, be sure to read *Lenovo Safety and General Information Guide* first.
- The latest electronic compliance and environmental information are available from the Lenovo compliance information Web sites.
 - To view compliance information go to: <http://www.lenovo.com/compliance>
 - To download environmental information go to: <http://www.lenovo.com/ecodeclaration>
- Some instructions in this guide may assume that you are using Windows® 10. If you are using another Windows operating system, some operations may be slightly different. If you are using other operating systems, some operations may not apply to you.
- The features described in this guide are common to most models. Some features may not be available on your computer or your computer may include features that are not described in this user guide.
- The illustrations used in this manual are for Lenovo ideapad 310-14ISK unless otherwise stated.
- The illustrations in this manual may differ from the actual product. Please refer to the actual product.

Regulatory Notice

- For details, refer to **Guides & Manuals** at <http://support.lenovo.com>.

First Edition (January 2016)

© Copyright Lenovo 2016.

LIMITED AND RESTRICTED RIGHTS NOTICE: If data or software is delivered pursuant to a General Services Administration "GSA" contract, use, reproduction, or disclosure is subject to restrictions set forth in Contract No. GS-35F-05925.

Contents

Chapter 1. Getting to know your computer	1
Top view	1
Left-side view	7
Right-side view	12
Bottom view	13
Chapter 2. Starting to use Windows 10	15
Configuring the operating system for the first time	15
Operating system interfaces	15
Putting the computer to sleep or shutting it down	18
Touch screen operation (ideapad 310 Touch-15ISK only)	20
Connecting to a wireless network	23
Get help from Windows	24
Chapter 3. Lenovo OneKey Recovery system	25
Chapter 4. Troubleshooting	27
Frequently asked questions	27
Troubleshooting	30
Appendix A. CRU instructions	33
Replacing the hard disk drive (ideapad 310-15ISK/ideapad 310 Touch-15ISK only)	34
Replacing the memory (on select models).....	37
Replacing the Mini PCI Express Card.....	40
Replacing the optical drive	43
Trademarks	46

Chapter 1. Getting to know your computer

●● Top view

■ ideapad 310-14ISK

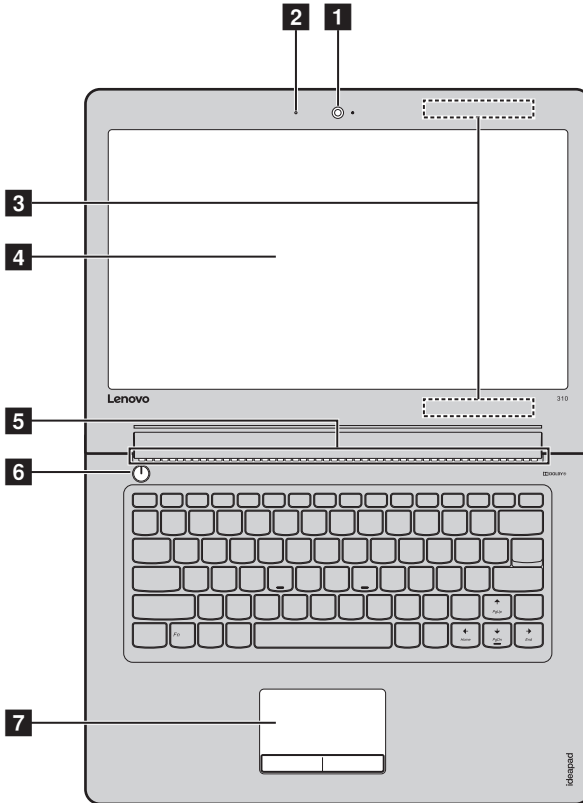

Chapter 1. Getting to know your computer

■ ideapad 310-15ISK/ideapad 310 Touch-15ISK

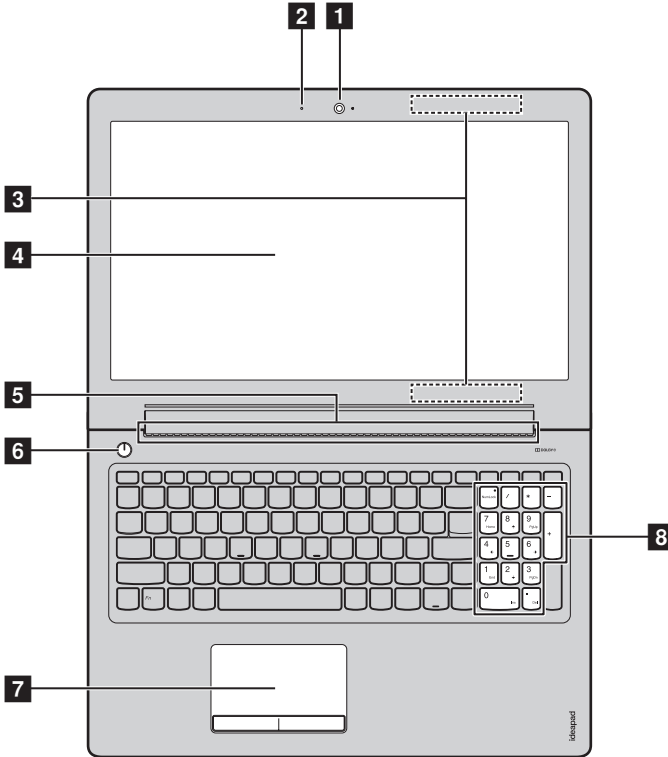

Note: The dashed areas indicate parts that are not visible externally.

ⓘ **Attention:**

- Do *not* open the display panel beyond 180 degrees. When closing the display panel, be careful *not* to leave pens or any other objects in between the display panel and the keyboard. Otherwise, the display panel may be damaged.

Chapter 1. Getting to know your computer

- 1 Integrated camera** Use the camera for video communication.
- 2 Built-in microphone** Capture sound which can be used for video conferencing, voice narration, or audio recording.
- 3 Wireless LAN antennas** Connect to a wireless LAN adapter to send and receive wireless radio signals.
- 4 Computer display (ideapad 310-14ISK/ideapad 310-15ISK)** The LCD display with LED backlight provides brilliant visual output.
Multi-touch screen (ideapad 310 Touch-15ISK) The LCD display with LED backlight provides brilliant visual output. Multi-touch function is available on this display.
- 5 Power button** Press this button to turn on the computer.
- 6 Ventilation slots** Dissipate internal heat.

Note: Make sure that none of the ventilation slots are blocked, or else overheating of the computer may occur.

- 7 Touch pad** The touch pad functions as a conventional mouse.
Touch pad: To move the pointer on the screen, slide your fingertip over the pad in the direction in which you want the pointer to move.
Touch pad buttons: The functions of the left/right side correspond to those of the left/right mouse button on a conventional mouse.

Note: You can enable/disable the touch pad by pressing F6 ()

- 8 Numeric keypad** For details, see “Using the keyboard” on page 4.

Chapter 1. Getting to know your computer

■ Using the keyboard

Your computer has number keys and function keys and may also have a numeric keypad (ideapad 310-15ISK/ideapad 310 Touch-15ISKonly) incorporated into its standard keyboard.

Numeric keypad

ideapad 310-15ISK/ideapad 310 Touch-15ISK

The keyboard has a separate numeric keypad. To enable or disable the numeric keypad, press the **Num Lock** key.

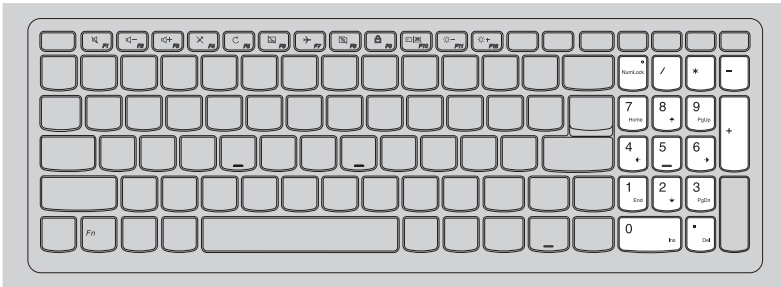







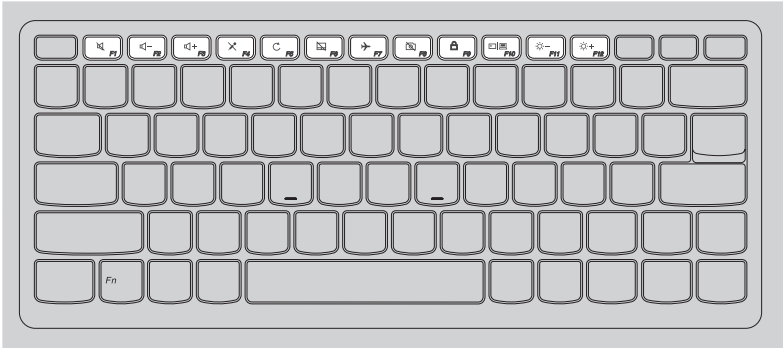





■ Using the keyboard

Hotkeys

You can access certain system settings quickly by pressing the appropriate hotkeys.



 F1 :	Mutes/unmutes the sound.	 F7 :	Enables/disables airplane mode.
 F2 :	Decreases the volume level.	 F8 :	Enables/disables camera.
 F3 :	Increases the volume level.	 F9 :	Locks/unlocks the LCD screen.
 F4 :	Enables/disables microphone.	 F10 :	Enables the external projector or dangles the external display.
 F5 :	Refreshes page.	 F11 :	Decreases display brightness.
 F6 :	Enables/disables the touch pad.	 F12 :	Increases display brightness.

Chapter 1. Getting to know your computer

Function key combinations

Through the use of the function keys, you can change operational features instantly. To use this function, press and hold **Fn** **1**; then press one of the function keys **2**.

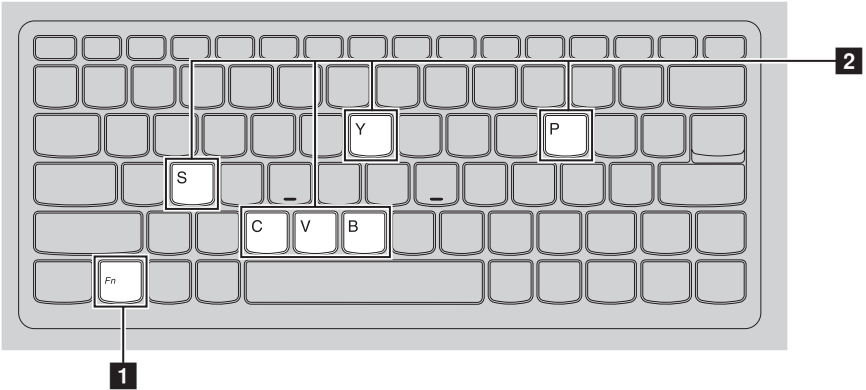

The following describes the features of each function key.

- | | |
|--------------------|---------------------------------|
| Fn + B: | Activate the break function. |
| Fn + P: | Activate the pause function. |
| Fn + C: | Enable/Disable the scroll lock. |
| Fn + Y: | Activate the system request. |
| Fn + S + V: | Set the battery Ship Mode. |

Left-side view

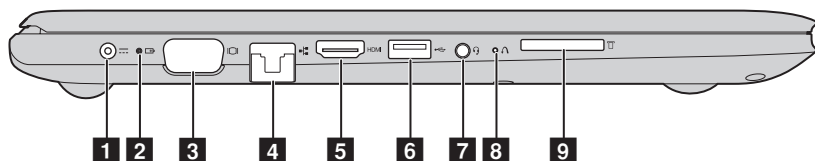

- 1 AC power adapter jack** Connects to the AC power adapter.
- 2 Battery/charging status indicator** 

AC power adapter status	Indicator status	Meaning
Disconnected	Off	The computer is in sleep mode or turned off; The battery has more than 20% charge.
	Solid amber	The battery has between 5% and 20% charge.
	Fast blinking amber	The battery has between 1% and 5% charge.
Connected	Slow blinking amber	The battery is being charged. When battery charge reaches 20%, the blinking color changes to white.
	Slow blinking white	The battery has between 20% and 80% charge and is still charging. When the battery reaches 80% charge the light will stop blinking.
	Solid white	The battery has more than 80% charge, charging will continue until the battery is fully charged.

- 3 VGA port** Connects to external display devices.
- 4 RJ-45 port** Connects the computer to an Ethernet network.
- 5 HDMI port** Connects to devices with HDMI input such as a TV or a display.

Chapter 1. Getting to know your computer

6 USB 3.0 port Connects to USB devices.

Note: For details, see “Connecting USB devices” on page 10.

7 Combo audio jack Connects to headsets.

Notes:

- The combo audio jack does not support conventional microphones.
- The recording function may not be supported if third-party headphones or headsets are connected, due to different industry standards.

8 Novo button When the computer is off, press this button to start the Lenovo OneKey Recovery system or the BIOS setup utility, or to enter the boot menu.

9 Memory card slot Insert memory cards (not supplied) here.

Note: For details, see “Using memory cards (not supplied)” on page 11.

Chapter 1. Getting to know your computer

■ Connecting network cables

To insert a network cable, do the following:

- ❶ Hold one connector of the network cable to press the RJ-45 cover down gently **1**.
- ❷ Insert the connector into the RJ-45 port **2**.

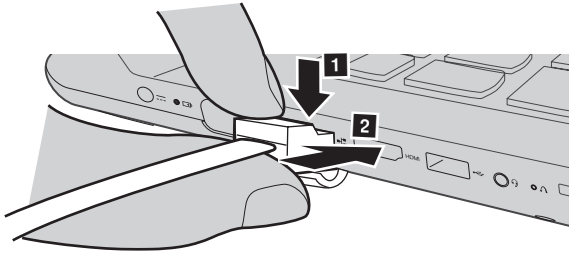

■ Software configuration

Consult your Internet Service Provider (ISP) for details on how to configure your computer.

Chapter 1. Getting to know your computer

■ Connecting USB devices

You can connect a USB device to your computer by inserting its USB plug (Type A) into the USB port on your computer.

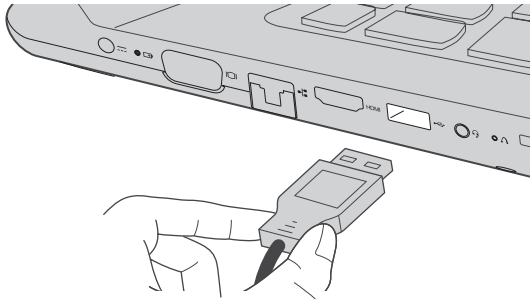

The first time you plug a USB device into a particular USB port on your computer, Windows automatically installs a driver for that device. After the driver has been installed, you can disconnect and reconnect the device without performing any additional steps.

Note: Typically, Windows detects a new device after it has been connected, and then installs the driver automatically. However, some devices may require you to install the driver before connecting. Check the documentation provided by the device's manufacturer before connecting the device.

Before disconnecting a USB storage device, make sure your computer has finished transferring data to that device. Click the **Safely Remove Hardware and Eject Media** icon in the Windows notification area to remove the device before disconnecting.

Note: If your USB device uses a power cord, connect the device to a power source before connecting it. Otherwise, the device may not be recognized.

■ Using memory cards (not supplied)

Your computer supports the following types of memory cards:

- Secure Digital (SD) card
- Secure Digital High Capacity (SDHC) card
- SD eXtended Capacity (SDXC) card
- MultiMediaCard (MMC)

Notes:

- Insert *only* one card in the slot at a time.
- This card reader does not support SDIO devices (e.g., SDIO Bluetooth, etc.).

Inserting a memory card

Insert the memory card until it touches the bottom of the slot.

Removing a memory card

Gently pull the memory card out of the memory card slot.

Note: Before removing the memory card, disable it by using the Windows safely remove hardware and eject media utility to avoid data corruption.

Chapter 1. Getting to know your computer

■ ■ Right-side view

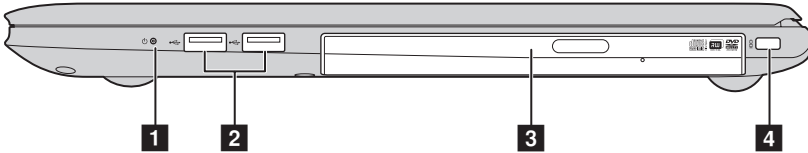

1 Power status indicator

Indicator	Indicator status	Meaning
Power status indicator	On (solid white)	The computer is powered on.
	Blinking	The computer is in sleep mode.
	Off	The computer is powered off.

2 USB port Connects to USB devices.

Note: For details, see “Connecting USB devices” on page 10.

3 Optical disc drive Reads/Burns optical discs.

Note: Some models are supplied with a dummy optical disc drive.

4 Kensington slot Attach a security lock (not supplied) here to help protect your computer from theft and unauthorized use. You can attach a security lock to your computer to help prevent it from being removed without your permission. For details on installing the security lock, please refer to the instructions shipped with the security lock that you have purchased.

■ ■ **Bottom view**

■ **ideapad 310-14ISK**

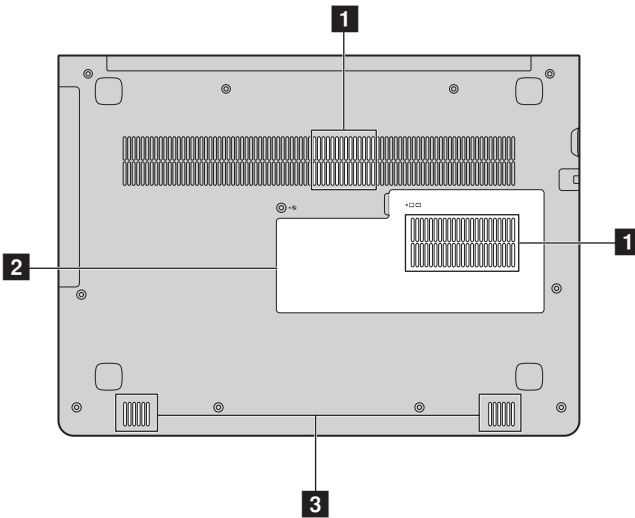

Chapter 1. Getting to know your computer

■ ideapad 310-15ISK/ideapad 310 Touch-15ISK

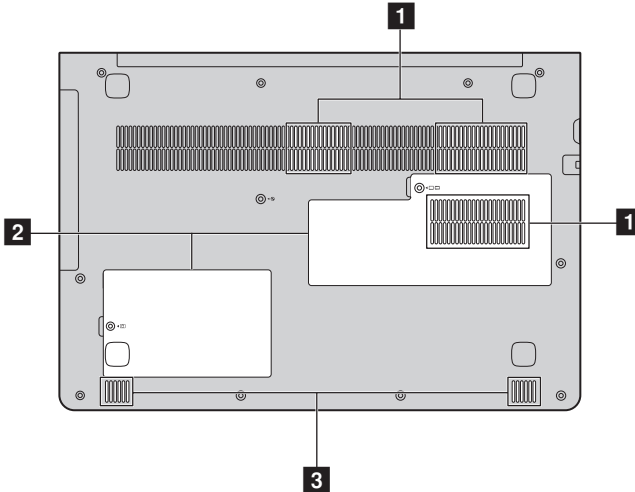

1 Ventilation slots Dissipate internal heat.

Note: Make sure that none of the ventilation slots are blocked, or else overheating of the computer may occur.

2 Bottom slot cover The hard disk drive, memory module, and mini-PCI Express Card are placed underneath.

3 Speakers Provide audio output.

Chapter 2. Starting to use Windows 10

■ ■ Configuring the operating system for the first time

You may need to configure the operating system when it is first used. The configuration process may include the procedures below:

- Accepting the end user license agreement
- Configuring the Internet connection
- Registering the operating system
- Creating a user account

■ ■ Operating system interfaces

The return of the Start menu

If you click the Start button in the lower-left corner, the Start menu is displayed.

To open the start menu, do one of the following:

- Select the Start button in the lower-left corner, the Start menu is displayed.
- Press the Windows key  on the keyboard.

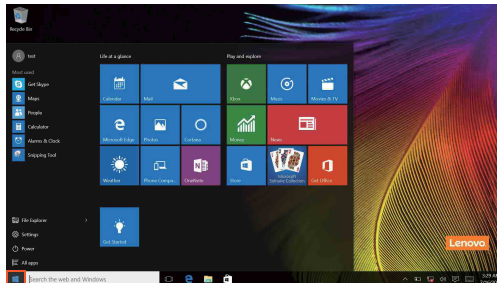

Chapter 2. Starting to use Windows 10

The power button is on the Start menu, select it you can choose to shut down or restart the computer, or put the computer into sleep mode.

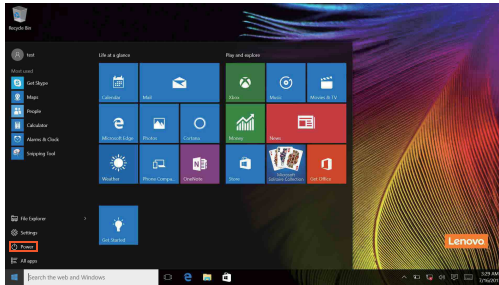

Through the Start menu, you can locate all the installed apps or view the frequently used apps.

The ACTION CENTER

Select the ACTION CENTER icon  on the taskbar and the ACTION CENTER is displayed.

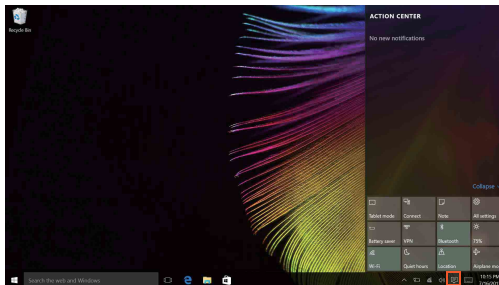

From the ACTION CENTER, you can examine important notifications from Windows and your apps. Moreover, you can change common settings quickly.

Task View in taskbar

In Windows 10, you can add a new desktop and switch between different desktops.

To add a new desktop, do the following:

- Select the Task View icon  in the taskbar area.

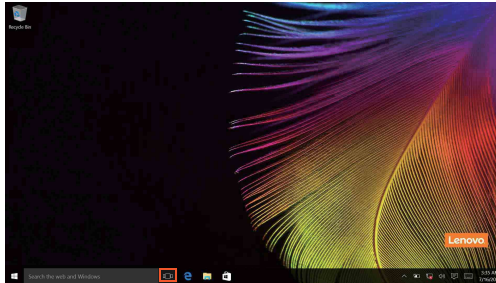

- Select **New desktop**.

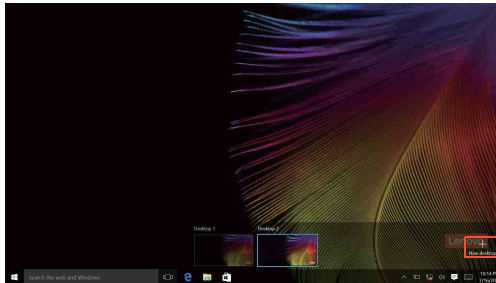

To switch between desktops, select the Task View icon , then select your desired desktop.

Also, you can manage apps in the multi-tasking view:

- ① Select the Task View button to display all apps in use on the screen.
- ② Select to enter the apps or close the apps.

■ ■ Putting the computer to sleep or shutting it down

When you have finished working with your computer, you can put it to sleep or shut it down.

■ Putting your computer to sleep

If you will be away from your computer for only a short time, put the computer to sleep.

When the computer is in sleep mode, you can quickly wake it to resume use, bypassing the startup process.

To put the computer to sleep, do one of the following:

- Close the display lid.
- Press the power button.
- Select the Start button, then select **Power**  → **Sleep**.

Note: Put your computer to sleep before you move it. Moving your computer while the hard disk drive is spinning can damage the hard disk, causing loss of data.

To wake the computer, do one of the following:

- Press any key on the keyboard.
- Press the power button.

■ Shutting down the computer

If you are not going to use your computer for a long time, shut it down. To shut down your computer, do one of the following:

- Select the Start button, then select **Power**  → **Shut down**.



- Right-click or press the Start button in the lower-left corner and select **Shut down or sign out** → **Shut down**.

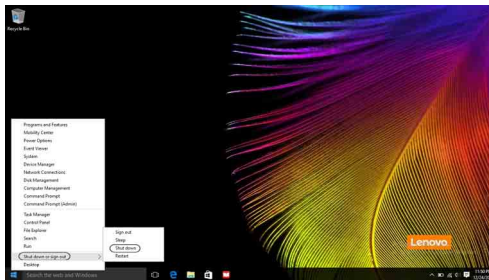

Chapter 2. Starting to use Windows 10

■ ■ Touch screen operation (ideapad 310 Touch-15ISK only)



The display panel can accept inputs like a tablet, using the multi-touch screen, or like a traditional notebook computer, using the keyboard and touch pad.

■ Multi-touch gestures

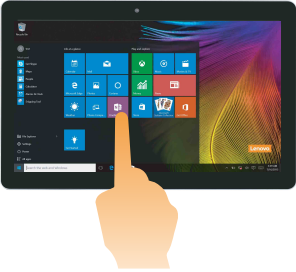
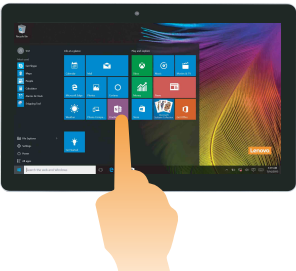
You can touch the screen with one or more fingertips to perform a variety of tasks.



Frequently used gestures	Tasks performed
<p>Tap Tap once on an item.</p>  An illustration of a hand with the index finger touching a tablet screen. The screen displays the Windows 10 Start menu with various application tiles. The hand is positioned as if it has just tapped one of the tiles.	<p>Performs an action, such as starting an app, opening a link, or performing a command. Similar to left-clicking with a mouse.</p>
<p>Press and hold Press your finger down and leave it there for a moment.</p>  An illustration of a hand with the index finger pressing down on a tablet screen. The screen displays the Windows 10 Start menu. The hand is positioned as if it is holding the screen down for a moment.	<p>Allows you to see detailed information before selecting an action. Can also open a menu with more options. Similar to right-clicking with a mouse.</p>

(continued)

Frequently used gestures	Tasks performed
<p data-bbox="159 339 228 363">Zoom</p> <p data-bbox="159 368 600 427">Move two fingers together or apart while touching the screen.</p>  An illustration of a tablet displaying a document. Two orange hand icons are shown on the screen, with their fingers moving towards each other to represent a zoom-in gesture.	<p data-bbox="632 339 1034 427">Zooms in and out on visual apps, such as pictures and maps. Can also jump to the beginning or end of a list.</p>
<p data-bbox="159 738 236 762">Rotate</p> <p data-bbox="159 767 598 826">Place two or more fingers on an item and then turn your hand.</p>  An illustration of a tablet displaying a colorful, abstract graphic. Two orange hand icons are shown on the screen, with their fingers placed on the graphic and curved arrows indicating a rotation gesture.	<p data-bbox="632 738 1020 826">Turns an object. (Note: Not all items can be rotated, depending upon the app.)</p>

Chapter 2. Starting to use Windows 10



(continued)

Frequently used gestures	Tasks performed
<p>Slide Drag your finger across the screen.</p> 	<p>Pans or scrolls through lists and pages. Can also move an object or be used to draw or write, depending upon the app. Similar to pressing and holding to pan and to scrolling with a mouse.</p>
<p>Swipe Start from any edge of the screen, then swipe inwards toward the center.</p> 	<p>Swiping in from the left edge can:</p> <ul style="list-style-type: none">• Bring in and open an app currently running in the background. <p>Swipe from the right edge can open the ACTION CENTER.</p>

■ ■ Connecting to a wireless network

Enabling wireless connection

To enable wireless functions, do one of the following:

- Select the ACTION CENTER icon  in the notification area, and then deselect **Airplane mode**.
- Press  to disable airplane mode.
- Select **Settings**  → **Network & Internet** → **Airplane mode** to open the network configuration page. Then toggle the airplane mode switch to **Off**.

Connecting to a wireless network

After wireless has been enabled, the computer will automatically scan for available wireless networks and display them in the wireless network list. To connect to a wireless network, click the network name in the list, and then click **Connect**.

Note: Some networks require a network security key or passphrase for connection. To connect to one of those networks, ask the network administrator or the Internet service provider (ISP) for the security key or passphrase.

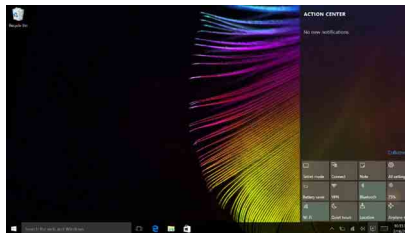

■ ■ Get help from Windows ---

If you have a problem with the operating system, see the Windows Get Started app. To open it, do the following:

- Move the cursor to the lower-left corner, and then select the Start button. Select **Get Started** from **All apps**.

Chapter 3. Lenovo OneKey Recovery system

The Lenovo OneKey Recovery system is software designed to back up and restore your computer. You can use it to restore the system partition to its original status in case of a system failure. You can also create user backups for easy restoration as required.

Notes:

- If your computer is preinstalled with a GNU/Linux operating system, OneKey Recovery system is not available.
- To utilize the features of the OneKey Recovery system, your hard disk already includes a hidden partition by default to store the system image file and the OneKey Recovery system program files. This default partition is hidden for security reasons, which explains why the available disk space is less than the stated capacity.

■ Backing up the system partition

You can back up the system partition to an image file. This image file can be used to restore the system partition. To back up the system partition:

- ① In Windows, press the Novo button or double-click OneKey Recovery icon to start the Lenovo OneKey Recovery system.
- ② Click **System Backup**.
- ③ Select a back-up location and click **Next** to start the backup.

Notes:

- You can choose a back-up location on the local hard disk drive or an external storage device.
- Remove the removable hard disk drive before starting the Lenovo OneKey Recovery system. Otherwise, data from the removable hard disk drive might be lost.
- The back-up process may take a while.
- The back-up process is only available when Windows can be started normally.

Chapter 3. Lenovo OneKey Recovery system

■ Restoring

You can choose to restore the system partition to its original status or to a previously created back-up point. To restore the system partition:

- ❶ In Windows, press the Novo button or double-click OneKey Recovery icon to start the Lenovo OneKey Recovery system.
- ❷ Click **System Recovery**. The computer will restart to the recovery environment.
- ❸ Follow the on-screen instructions to restore the system partition to its original status or to a previously created back-up point.

Notes:

- The recovery process is irreversible. Make sure to back up any data you wish to save on the system partition before starting the recovery process.
- The recovery process may take a while. So be sure to connect the AC power adapter to your computer during the recovery process.
- The above instructions should be followed when Windows can be started normally.

If Windows cannot be started, then follow the steps below to start the Lenovo OneKey Recovery system:

- ❶ Shut down the computer.
- ❷ Press the Novo button. From the **Novo Button Menu**, select **System Recovery** and press Enter.

Chapter 4. Troubleshooting

■ ■ Frequently asked questions

This section lists frequently asked questions by category.

■ Finding information

What safety precautions should I follow when using my computer?

The *Lenovo Safety and General Information Guide* which came with your computer contains safety precautions for using your computer. Read and follow all the precautions when using your computer.

Where can I find the hardware specifications for my computer?

You can find hardware specification for your computer on the printed flyers which came with your computer.

Where can I find warranty information?

For the warranty applicable to your computer, including the warranty period and type of warranty service, see the Lenovo limited warranty flyer that came with your computer.

■ Drivers and preinstalled software

Where are the installation discs for Lenovo preinstalled software (desktop software)?

Your computer does not come with installation discs for Lenovo preinstalled software. If you need to reinstall any preinstalled software, you can find the installation program on the D partition of your hard disk (for select models, on the C partition). If you cannot find the installation program there, you can also download it from the Lenovo consumer support website.

Where can I find drivers for the various hardware devices of my computer?

If your computer is preinstalled with a Windows operating system, Lenovo provides drivers for all the hardware devices that you need on the D partition of your hard disk (for select models, on the C partition). You can also download the latest device drivers from the Lenovo consumer support website.

Chapter 4. Troubleshooting

■ Lenovo OneKey Recovery system

Where are the recovery discs?

Your computer did not come with recovery discs. Use the Lenovo OneKey Recovery system if you need to restore the system to its factory status.

What can I do if the back-up process fails?

If you can start the backup but it fails during the back-up process, try the following steps:

- ❶ Close all open programs, and then restart the back-up process.
- ❷ Check to see if the destination media is damaged. Select another path and then try again.

When do I need to restore the system to its factory status?

Use this feature when the operating system fails to start up. If there is critical data on the system partition, back it up before starting recovery.

■ BIOS setup utility

What is the BIOS setup utility?

The BIOS setup utility is ROM-based software. It displays basic computer information and provides options for setting boot devices, security, hardware mode, and other preferences.

How can I start the BIOS setup utility?

To start the BIOS setup utility:

- ❶ Shut down the computer.
- ❷ Press the Novo button and then select **BIOS Setup**.

How can I change the boot mode?

There are two boot modes: **UEFI** and **Legacy Support**. To change the boot mode, start the BIOS setup utility and set boot mode to **UEFI** or **Legacy Support** on the boot menu.

When do I need to change the boot mode?

The default boot mode for your computer is **UEFI** mode. If you need to install a legacy operating system, such as Windows, Linux or Dos, etc (that is, any operating system before Windows 8) on your computer, you must change the boot mode to **Legacy Support**. The legacy operating system, such as Windows, Linux or Dos, etc cannot be installed if you don't change the boot mode.

■ Getting help

How can I contact the customer support center?

See “Chapter 3. Getting help and service” of *Lenovo Safety and General Information Guide*.

■ ■ Troubleshooting

Display problems

When I turn on the computer, nothing appears on the screen.

- If the screen is blank, make sure that:
 - The AC power adapter is connected to the computer, and the power cord is plugged into a working electrical outlet.
 - The computer power is on. Press the Power button again for confirmation.
- If these items are set correctly, and the screen remains blank, have the computer serviced.

When I turn on the computer, only a white cursor appears on a blank screen.

- Restore backed-up files to your Windows environment or the entire contents of your hard disk to its original factory contents using the Lenovo OneKey Recovery system. If you still see only the cursor on the screen, have the computer serviced.

The screen goes blank while the computer is on.

- Your power management is enabled. Do one of the following to resume from sleep mode:
 - Press any key on the keyboard.
 - Press the Power button.
 - Press **F9** () to confirm whether the backlight of the LCD screen has been turned off.

Sleep problems

The critical low-battery error message appears, and the computer immediately turns off.

- The battery power is getting low. Connect the AC power adapter to the computer.

The computer enters sleep mode immediately after Power-on.

- Make sure that:
 - The battery is charged.
 - The operating temperature is within the acceptable range. See “Chapter 2. Use and care Information” in the *Lenovo Safety and General Information Guide*.



Note: If the battery is charged and the temperature is within range, have the computer serviced.

The computer does not return from sleep mode and the computer does not work.

- If your computer is in sleep mode, connect the AC power adapter to the computer, then press the Windows button or the Power button.
- If the system still does not return from sleep mode, your system has stopped responding, and you cannot turn off the computer; reset the computer. Unsaved data may be lost. To reset the computer, press and hold the Power button for eight seconds or more. If the computer still does not reset, remove the AC power adapter.

Display panel problems

The screen is blank.

- Do the following:
 - If you are using the AC power adapter or the battery, and the battery status indicator is on, press **F12** () to make the screen brighter.
 - If the power indicator is blinking, press the Power button to resume from sleep mode.
 - Press **F9** () to confirm whether the backlight of the LCD screen has been turned off.
 - If the problem persists, follow the solution in the next problem “The screen is unreadable or distorted.”

The screen is unreadable or distorted.

- Make sure that:
 - The screen resolution and color quality are correctly set.
 - The monitor type is correct.

Incorrect characters appear on the screen.

- Is the operating system or programs installed correctly? If they are installed and configured correctly, have the computer serviced.

Sound problems

No sound can be heard from the speakers even when the volume is turned up.

- Make sure that:
 - The Mute function is off.
 - The combo audio jack is not being used.
 - Speakers are selected as the playback device.

Chapter 4. Troubleshooting

Battery problems

Your computer shuts down before the battery status indicator shows empty.

-or-

Your computer operates after the battery status indicator shows empty.

- Recharge the battery.

Other problems

Your computer does not respond.

- To turn off your computer, press and hold the Power button for eight seconds or more. If the computer still does not respond, remove the AC power adapter.
- Your computer might lock when it enters sleep mode during a communication operation. Disable the sleep timer when you are working on the network.

The connected external device does not work.

- Do *not* connect or disconnect any external device cables other than USB while the computer power is on. Otherwise, you might damage your computer.
- When using high power consumption external devices, such as an external USB optical drive, use an external device power adapter. Otherwise, the device may not be recognized, or the system may shut down as a result.

Appendix A. CRU instructions

Customer Replaceable Units (CRUs) are parts that can be upgraded or replaced by the customer. If a CRU is determined to be defective during the warranty period, a replacement CRU will be provided to the customer. Customers are responsible for installing the self-service CRUs for this product. Customers also can install optional-service CRUs, which might require some technical skills or tools, or request that a technician install the optional-service CRU under the terms of the applicable warranty service type for your country or region.

Notes:

- The illustrations used in this chapter are of the Lenovo ideapad 310-14ISK, unless otherwise stated.
- The illustrations in this manual might differ from the actual product. Please refer to the actual product.
- The CRU service is only applicable to certain countries.

CAUTION:

Set the built-in battery in Ship Mode before replacing a CRU or sending your computer for service.

- ❶ Turn off the computer and disconnect the AC adapter.
- ❷ Press **Fn + S + V**.
- ❸ Press the Power button to verify if Ship Mode has been set.

Note: When set in Ship Mode, the battery does not supply power to the computer. To awake the battery from Ship Mode, connect the AC adapter to your computer.

■ ■ Replacing the hard disk drive (ideapad 310-15ISK/ideapad 310 Touch-15ISK only)

You can increase the storage capacity of your computer by replacing the hard disk drive with one of greater capacity. You can purchase a new hard disk drive from your reseller or Lenovo marketing representative.

Notes:

- Replace the hard disk drive only for upgrading or repair. The connectors and bay of the hard disk drive were not designed for frequent changes or drive swapping.
- The preinstalled software are not included on an optional hard disk drive.

Handling a hard disk drive

- Do not drop the drive or subject it to physical shock. Put the drive on a material, such as soft cloth, that absorbs any physical shock.
- Do not apply pressure to the cover of the drive.
- Do not touch the connector of the drive.

The hard disk drive is very sensitive. Incorrect handling can cause damage and permanent loss of data on the hard disk. Before removing the hard disk drive, make a backup copy of all the information on the hard disk, and then turn the computer off. Never remove the hard disk drive while the system is operating or in sleep mode.

Appendix A. CRU instructions

To replace the hard disk drive, do the following:

- ❶ Turn off the computer. Disconnect the AC power adapter and all cables from the computer.
- ❷ Close the computer display and turn the computer over.
- ❸ Remove the screw **❶** , and then remove the hard disk drive(HDD) slot compartment cover **❷** .

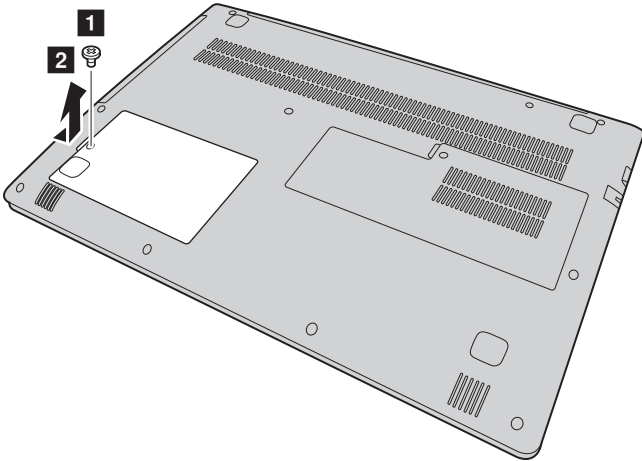

Appendix A. CRU instructions

- 4 Remove the hard disk drive by gently pulling it in the direction of the arrow **3**.

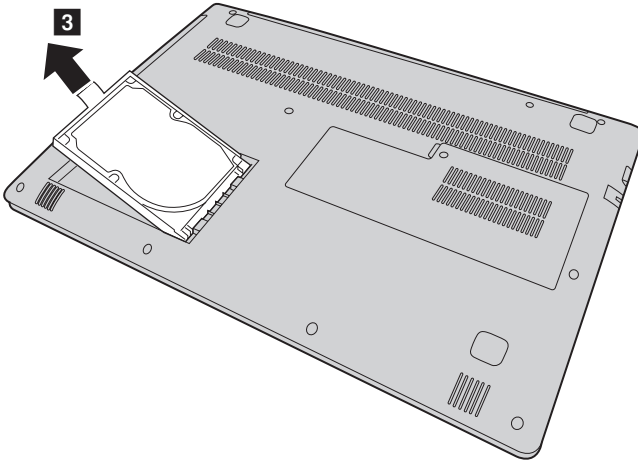

- 5 Detach the frame from the hard disk drive.
- 6 Attach the frame to a new hard disk drive.
- 7 Slide the new hard disk drive firmly into place.
- 8 Reinstall the hard disk drive(HDD) slot compartment cover and tighten the screw.
- 9 Turn the computer over again.
- 10 Connect the AC power adapter and the cables to the computer.

■ ■ Replacing the memory (on select models)

You can increase the amount of memory in your computer by installing double data rate fourth generation synchronous dynamic random access memory (DDR4)-available as an option-in the memory slot of your computer. DDR4 modules are available in various capacities.

Notes:

- Use only the memory types supported by your computer. If you incorrectly install optional memory, or install an unsupported memory type, a warning beep will sound when you try to start the computer.
- Select types of memory is not self-serviced, if necessary consult Lenovo service center.

To install a DDR4 module, do the following:

- ① Touch a metal table or a grounded metal object to reduce any static electricity in your body, which could damage the DDR4. Do not touch the contact edge of the DDR4 module.
- ② Turn off the computer. Disconnect the AC power adapter and all cables from the computer.
- ③ Close the computer display and turn the computer over.
- ④ Remove the screw **1** , and then remove the memory /Mini PCI Express Card slot compartment cover **2** .

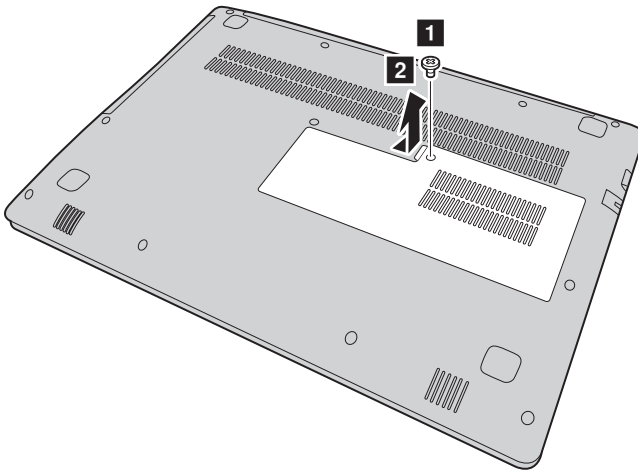

Appendix A. CRU instructions

- 5 Remove DDR4 module by pulling out on the latches on both edges of the socket at the same time. Be sure to save the old DDR4 for future use.

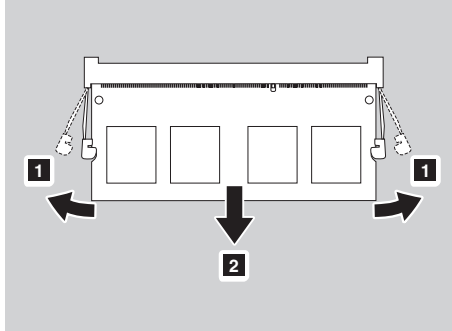

- 6 Align the notch of the DDR4 module with the protrusion of the socket and gently insert the new module at a 30-45° angle.
- 7 Push the DDR4 module down until the latches on both sides of the socket lock into its position.

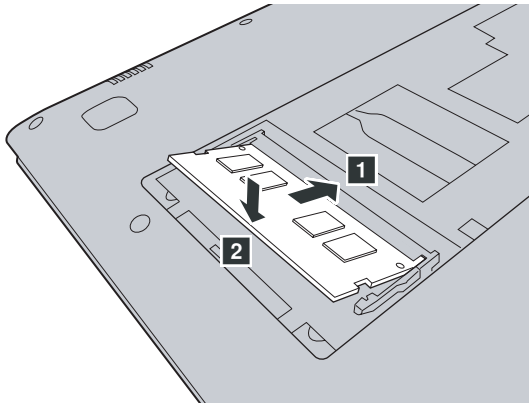

- 8 After aligning the attachment clips with their matching gaps, reinstall the memory/Mini PCI Express Card slot compartment cover.
- 9 Tighten the screw.
- 10 Turn the computer over again.
- 11 Connect the AC power adapter and the cables to the computer.

Appendix A. CRU instructions

To make sure that the DDR4 module is installed correctly, do as follows:

- ① Press the Novo button to open the Novo button menu.
- ② Select the **BIOS Setup**. The **System Memory** item shows the total amount of memory installed in your computer.

Appendix A. CRU instructions

■ ■ Replacing the Mini PCI Express Card

To replace the Mini PCI Express Card, do the following:

- ❶ Turn off the computer. Disconnect the AC power adapter and all cables from the computer.
- ❷ Close the computer display and turn the computer over.
- ❸ Remove the memory/Mini PCI Express Card slot compartment cover.
 - a. Loosen the screw that secures the compartment cover ❶.
 - b. Remove the compartment cover ❷.

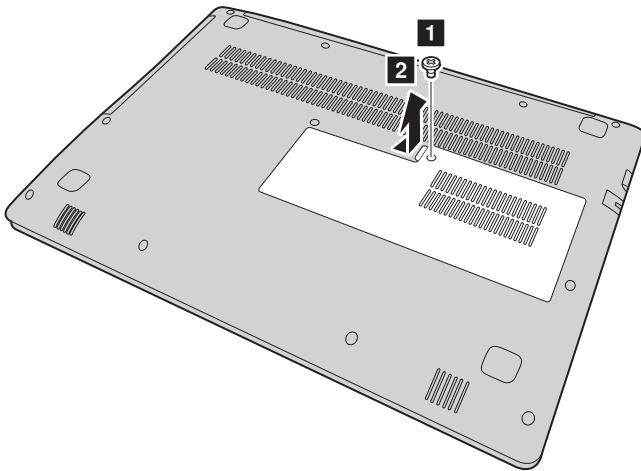

- ❹ If a tool for removing connectors is included in the package with the new card, use it to disconnect the cables ❸ from the card. If no such tool is included, disconnect the cables by holding up the connectors with your fingers and gently unplugging them. Then remove the screws ❹ and the card pops up.

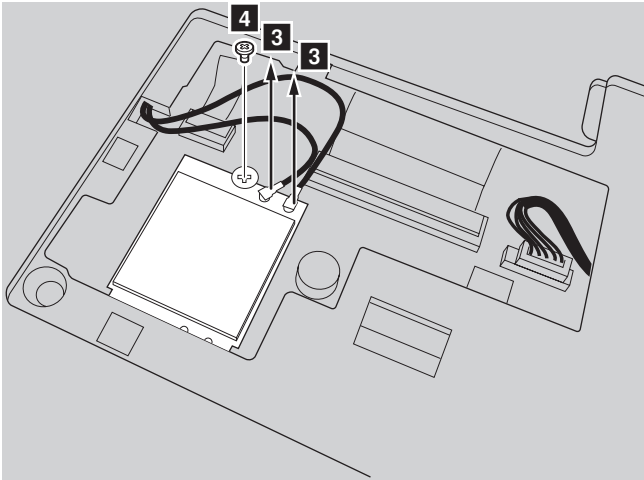

- 5 Remove the card in the direction shown by 5.

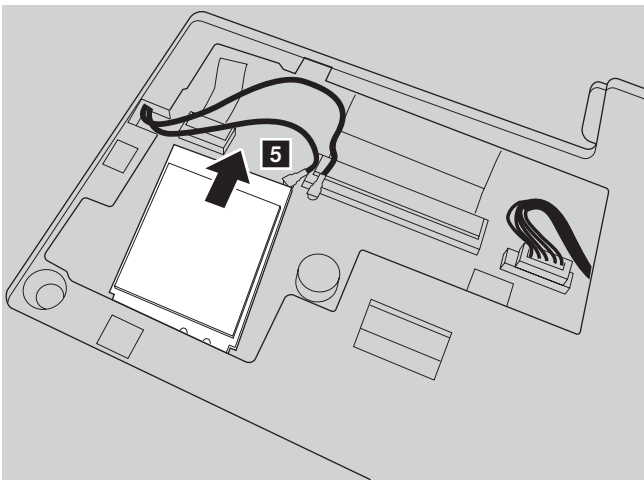

- 6 Align the contact edge of the new Mini PCI Express Card with the corresponding socket.
- 7 Pivot the card until you can snap it into place. Then secure the card with the screw.

Appendix A. CRU instructions

- ⑧ Connect the antenna cables to the new Mini PCI Express Card. Be sure to attach the gray cable to the connector marked "MAIN" or "M" on the card, and the black cable to the connector marked "AUX" or "A".
- ⑨ Reinstall the compartment cover and tighten the screw.
- ⑩ Turn the computer over again.
- ⑪ Connect the AC power adapter and the cables to the computer.

■ ■ Replacing the optical drive

To replace the optical drive, do the following:

- ❶ Turn off the computer. Disconnect the AC power adapter and all cables from the computer.
- ❷ Close the computer display and turn the computer over.
- ❸ Remove the screw **1** .

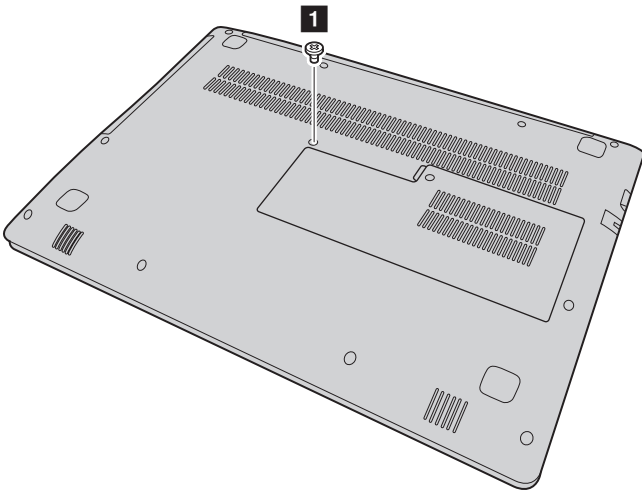

Appendix A. CRU instructions

- 4 Gently pull the optical drive out from its cavity **2** .

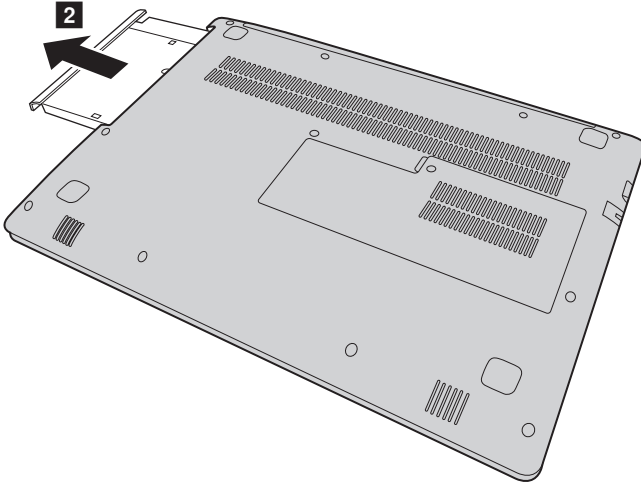

- 5 Insert a new optical drive and tighten the screw to secure the drive.
- 6 Turn the computer over again.
- 7 Connect the AC power adapter and the cables to the computer.

Appendix A. CRU instructions

The following table provides a list of CRUs for your computer, and informs you of where to find replacement instructions.

Self-service CRUs

	Safety, Warranty, and Setup Guide	User Guide
AC power adapter	×	
Optical drive		×
Hard disk drive		×
Mini PCI Express Card		×

Optional-service CRUs

	Safety, Warranty, and Setup Guide	User Guide
Memory		×

Trademarks

The following terms are trademarks or registered trademarks of Lenovo in the United States, other countries, or both.

Lenovo
OneKey

Microsoft and Windows are trademarks of Microsoft Corporation in the United States, other countries, or both.

Other company, products, or service names may be trademarks or service marks of others.

