

ring



Spotlight Cam

Smart Security at Every Corner of Your Home

Your new Spotlight Cam lets you extend the Ring of Security around your entire property.

Now, you'll always be the first to know when someone's in your yard, and you can watch over your home from anywhere.

Monitor your home, prevent crime and protect your property – all from your phone, tablet or PC.

Contents

1. Charging
2. In-app Setup
3. Physical Installation
4. Features
5. Troubleshooting

1. Charge
the provided
battery.

Charge the battery

First, fully charge the battery by plugging it into a power source using the provided orange cable.

The small light on top will glow green once fully charged.

 = Charging  = Charged

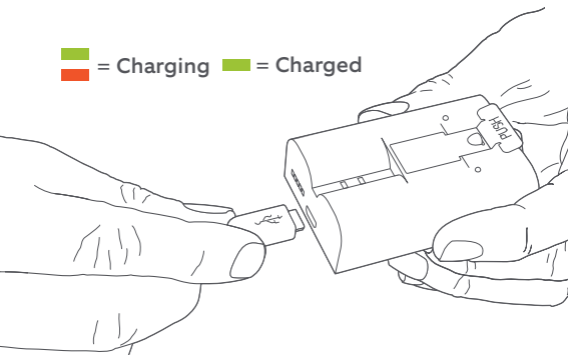

If you can't wait to play with your Spotlight Cam, go ahead and set it up. But, we recommend fully charging it before installation.

Insert the battery

After charging, insert the battery in your Spotlight Cam until it clicks into place. Then, click the door closed.

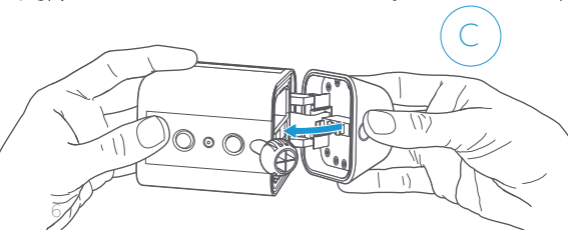
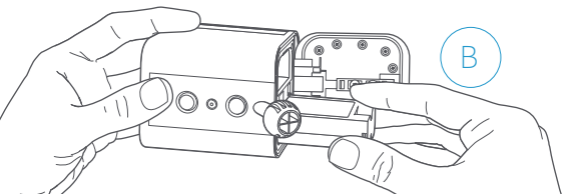
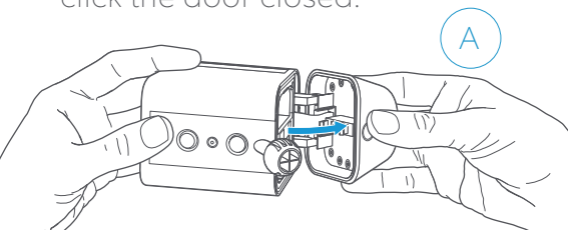

2. Set up
your
Spotlight
Cam in the
Ring app.

Download the Ring app

The Ring app walks you through setting up and managing your Spotlight Cam.

Search for “Ring” in one of the app stores below, or visit:
ring.com/app.



Grab your Wi-Fi password

It's required for the in-app setup. Write it down below so it's handy when you need it:

Your Wi-Fi password 

Set up your Spotlight Cam near your router

In the Ring app, select **Set Up Device**.

When prompted, select **Spotlight Cam** and follow the in-app instructions.



Try it out!

After setup, tap the Live View button in the Ring app to see video from the camera.

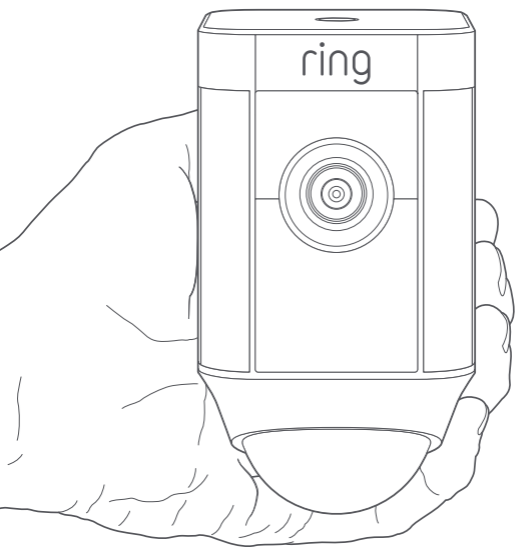

White light flashing?

If the light on the bottom of your Spotlight Cam flashes after setup, it's updating its internal software.

The update process can take up to a few minutes. The light stops flashing when the update is complete.

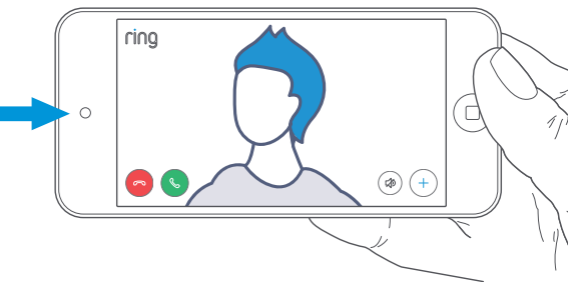

Test video quality outside.

Now, take your Spotlight Cam outside, near the place where you want to install it. Test video quality again.

Everything look good?

Continue to the next section.

Something not right?

Jump ahead to the troubleshooting section.

3. Install your
Spotlight
Cam on
the wall.

Contents...



Screwdriver

Use the screwdriver handle to hold the provided bit.



Screwdriver Bit

Use the Phillips end for installing the mounting bracket and the star-shaped end for the security screw on the mounting plate.



Drill Bit

Use this to pre-drill holes if installing on a masonry surface, such as stucco or brick.

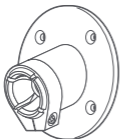

Mounting Bracket

Attach this to the wall first, then pop Spotlight Cam into the socket.



Install Screws (5)

Use these to secure the mounting bracket to your wall.



Wall Anchors (5)

Use these to attach the mounting bracket to your wall if installing on a hard surface, such as stucco or brick.

How to remove the mounting plate...

1. Press button to open battery compartment

2. Remove security screw

3. Press release button

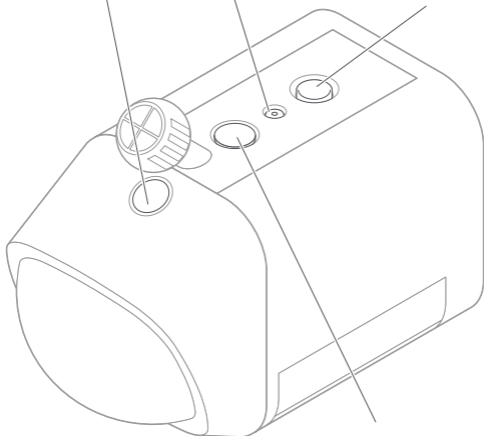

4. Remove weather seal, and insert in unused hole

Mounting on a wall

To install Spotlight Cam on a wall, insert the mounting plate with the ball socket pointing down.

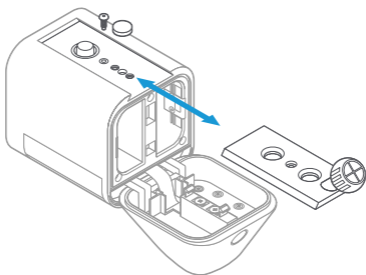
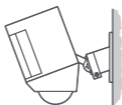

Mounting on an eave

To install Spotlight Cam on an eave or overhang, insert the mounting plate with the ball socket pointing up.

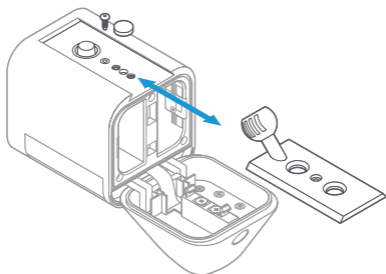
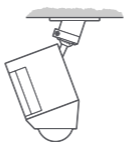

Select an install height

When mounted at 9 feet off the ground, with the motion detector parallel to the ground, the motion sensor is optimized to detect human-sized objects at up to 30 feet.

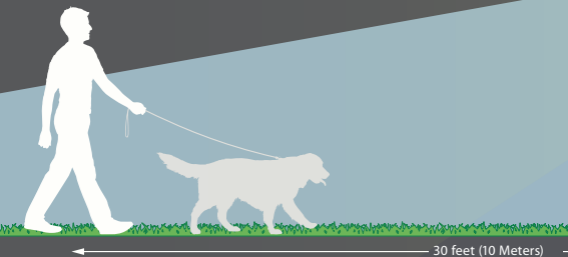

Parallel to ground

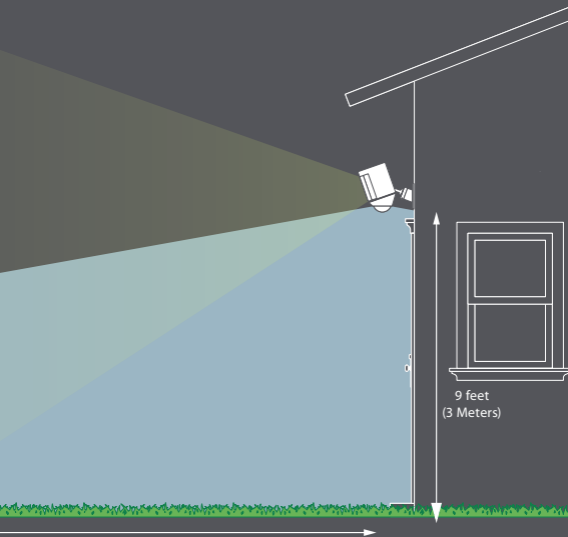
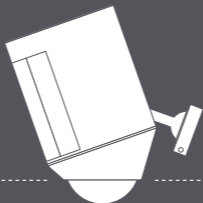

9 feet
(3 Meters)

Install the mounting bracket

First, mark your holes using the mounting bracket as a guide.

If installing on a masonry surface, first drill holes using the provided drill bit. Insert the wall anchors before inserting the screws.

If installing on a wood surface, you can screw the bracket directly into your wall.

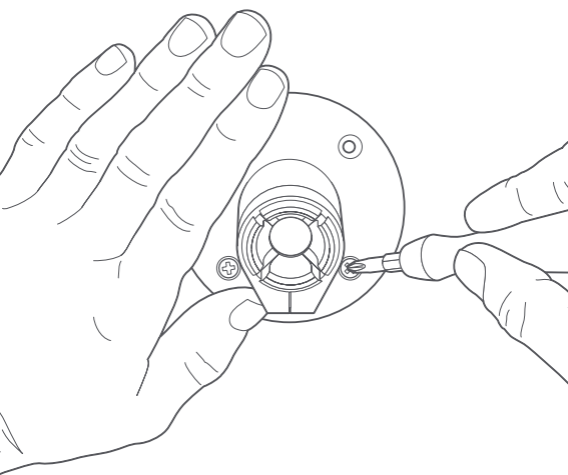



If you have a Ring Solar Panel...

Ring Solar Panel charges your Spotlight Cam continuously—no need to charge or swap out batteries.

If you don't yet have a Ring Solar Panel, skip this section.

For more info, visit [ring.com](https://www.ring.com)

Mark the Holes

Select an install location where Solar Panel can get at least 1 hour of direct sunlight a day.

Mark the holes using the mounting arm as a template.

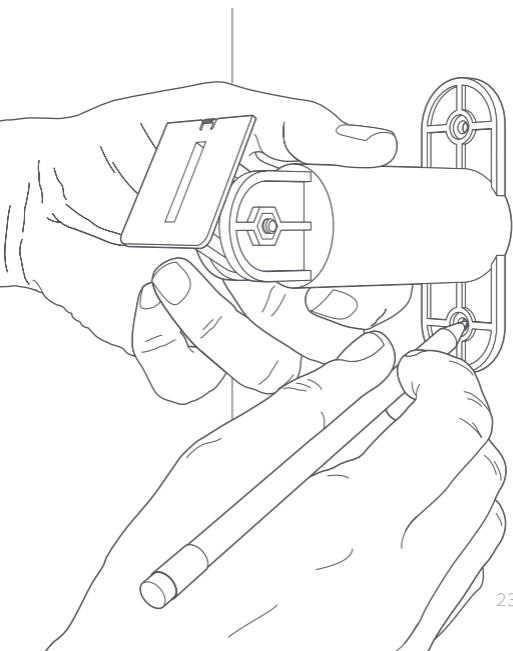

Install Wall Anchors (optional)

If installing on a hard surface (such as stucco or brick), use the included drill bit to pre-drill the mounting holes, then insert the wall anchors.

If installing on wood or siding, skip this step.

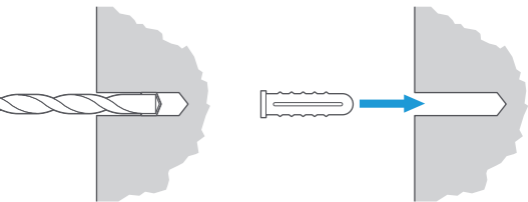

Screw in the Mounting Arm

Drive the included mounting screws into your wall (or the wall anchors, if installing on a hard surface) until the mounting arm is secure.

Note: It's easier to screw in the mounting arm before you attach the solar panel.

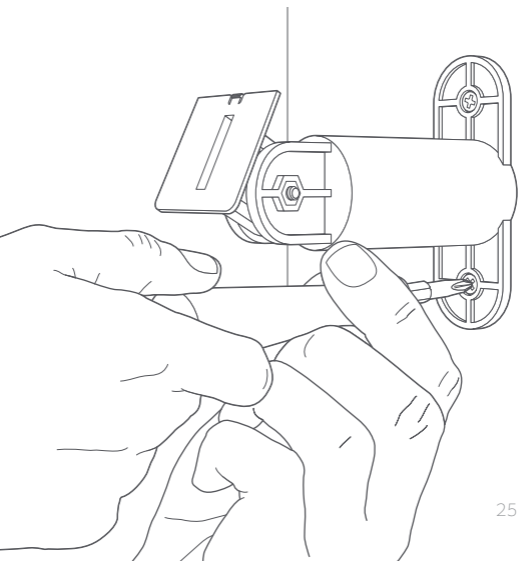

Attach the Solar Panel

Slot the Solar Panel onto the mounting arm, and make sure it's secure.

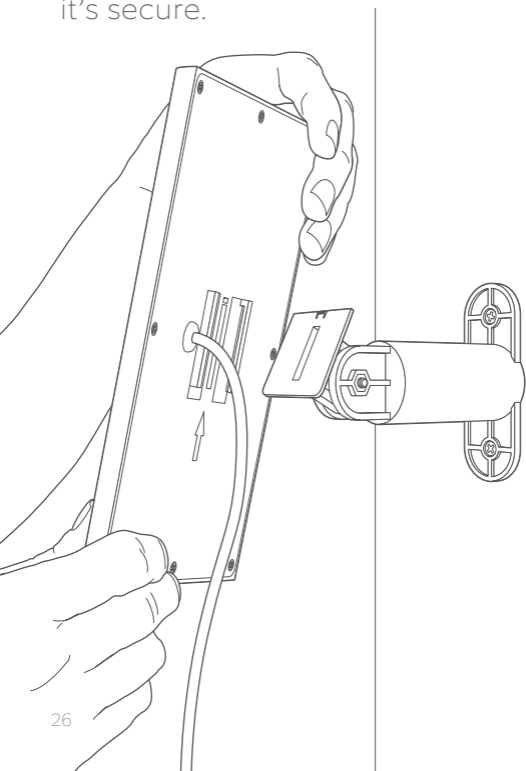

Adjust the Angle

Loosen the screw on the mounting arm and adjust the panel to your desired angle, then re-tighten the screw to secure your setting.

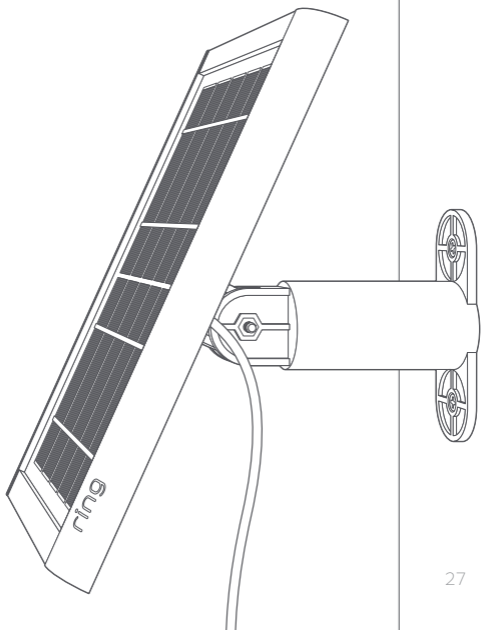

Connect the Cable

Remove the weather proofing plug nearest to the bottom of your Spotlight Cam.

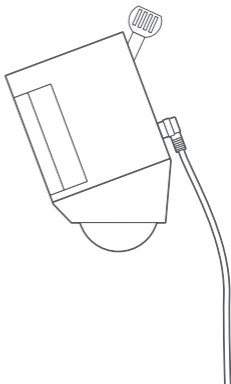

Then place the power plug from your Ring Solar Panel into the power input, taking care to align the screw holes.

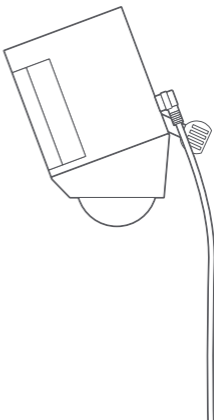

Secure the Cable

Secure the power cable to your Spotlight Cam with the included screws. This helps ensure that your Spotlight Cam stays water-tight.

Note: Make sure you charge and insert the included battery into your Spotlight Cam. Ring Solar Panel keeps the battery charged, but does not replace it.

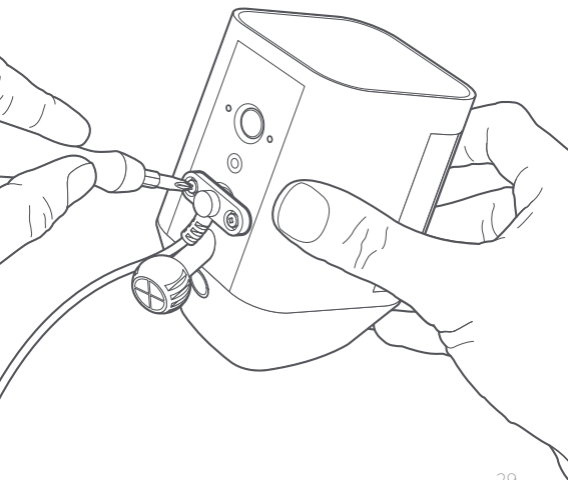

Attach Spotlight Cam to the mounting bracket

Push the ball into the socket until it pops into place.

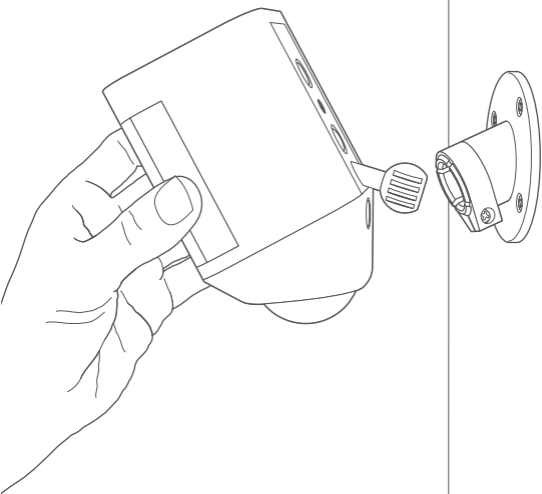

Adjust the camera angle

To ensure accurate motion detection, position the camera with the motion detector parallel to the ground.

Tighten the side screw to secure the camera position.

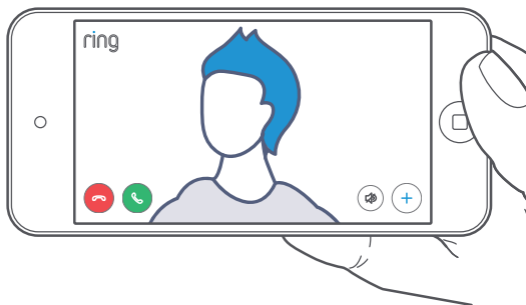

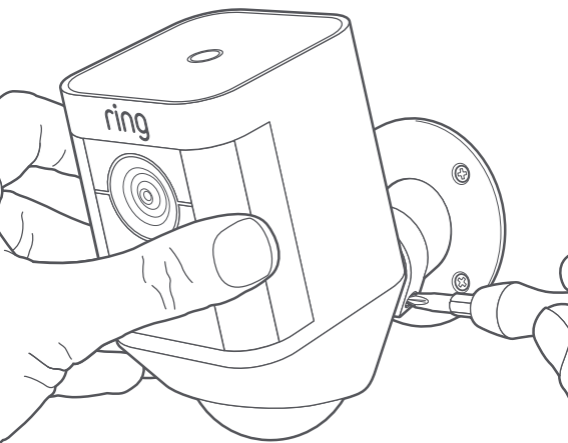

4. Check
out all the
exciting
features.

After setup, select your Spotlight Cam in the Ring app

This will bring you to the Device Dashboard, where you can change settings and access various features.

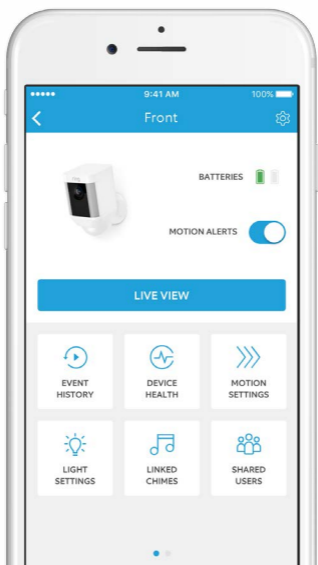

BATTERIES



Check the level of the battery (or batteries) in your Spotlight Cam.

MOTION ALERTS



Turn notifications on or off for motion events.

LIVE VIEW

Tap to see live video from Spotlight Cam. From here, you can see, hear and speak to visitors, and control the siren and lights.



EVENT
HISTORY

View a log of all the events captured by your Spotlight Cam in **Event History**.



DEVICE
HEALTH

Visit **Device Health** to diagnose any problems you run into.



MOTION
SETTINGS

Select **Motion Settings** to customize motion detection settings.

Motion Detection



Spotlight Cam utilizes three Motion Zones, which are customizable areas Spotlight Cam will monitor and alert you about. When motion is detected in one of your Motion Zones at night, the lights on Spotlight Cam turn on.

To customize your Motion Zones and set how long the lights will stay on for when triggered, tap Motion Settings, then Motion Zones.

Notifications

If your phone is locked when the camera captures a live event, a notification is displayed on your home screen.

If your phone has a passcode, you'll need to enter it to access the live event.





Select Motion Settings

to customize your motion preferences.



Motion Zones

Adjust the areas that will trigger motion events and turn the lights on at night.



Motion Schedule

Schedule times when you don't want to receive motion alerts.



Smart Alerts

Adjust how often you want to be notified for motion events.

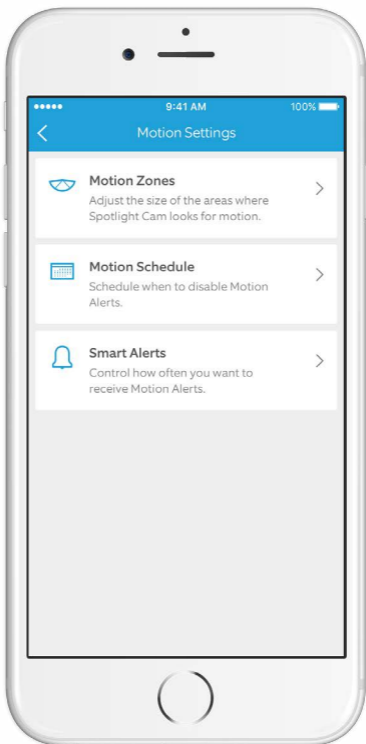



Select Motion Zones

Customize the areas that will trigger the camera to turn on when motion is detected.

Simply tap on the diagram to turn a motion zone on or off.

You can also set whether or not the lights turn on when motion is detected at night.

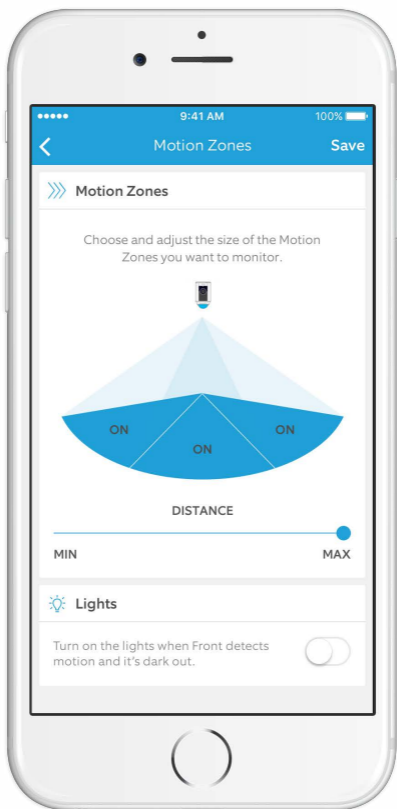



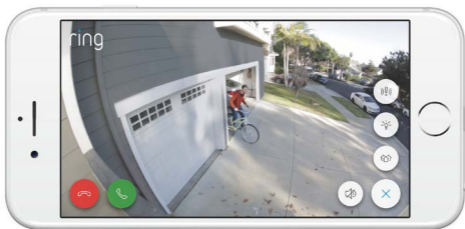

Live Events



A live event begins when motion is detected or when selecting Live View.

During live events, you can access these features:

-  **Two-way Talk** – Speak to visitors and hear what they have to say.
-  **Siren** – Activate the siren.
-  **Lights** – Turn the lights on and off.
-  **Ring Neighborhoods** – Share suspicious events with neighbors.

Ring Video Recording

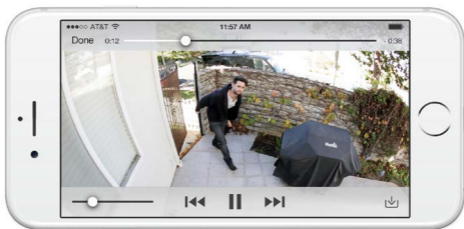

This optional feature saves recordings of every event your Spotlight Cam captures, allowing you to share them with others.

You can access these events on any device running the Ring app or by logging into your account at: ring.com/activity.

Learn more at:

ring.com/video-recording



Your new Spotlight Cam includes a free trial of Ring Video Recording for you to enjoy. Watch your email inbox for important announcements about this service.

5. Having
trouble?

Here are
some
answers...

Spotlight Cam is not powering on.

Make sure the battery is correctly inserted in its compartment. If it's not there, put the battery in.

If it's inserted, remove the battery and use the orange power cable to plug the battery into a power outlet. When only the green light is illuminated, the battery is fully charged.

There are two battery compartments, but Spotlight Cam only comes with one battery. Do I need another battery for Spotlight Cam to work?

Spotlight Cam only needs one battery to work properly. You can purchase another battery on [Ring.com](https://www.ring.com) for extended battery life, and to avoid downtime during battery charges.

I'm having trouble completing the in-app setup.

When the in-app setup fails, look at the light on the bottom of your Spotlight Cam. The light color indicates the issue.

Flashing red means your Wi-Fi password was entered incorrectly. Select your Wi-Fi network in your phone settings, select the option to forget it, then reconnect to it again to confirm that you're using the correct password during setup.

Flashing blue means your Spotlight Cam may be too far from your router to get a decent signal. You may need to get a **Ring Chime Pro** to boost the Wi-Fi signal to your Spotlight Cam.

Learn more at: ring.com/chime-pro

Flashing green indicates a possible issue with your internet connection. Unplug your modem or router for 40 seconds, plug it back in, then repeat the setup process.

Why can't I find the temporary Ring network on my phone?

Sometimes your phone fails to pick up the temporary Ring network. If this happens, go to your phone settings, turn off your Wi-Fi connection, wait 30 seconds and turn it back on.

If the Ring network still fails to appear, ensure that your Spotlight Cam has at least one battery inserted, and that it's fully charged.

If none of the above helped...

Perform a hard reset on your Spotlight Cam by holding down the setup button for 15 seconds, waiting 30 seconds and repeating the setup process.

If that didn't help...

Turn off cellular data and Bluetooth on your mobile device and try the setup again. You can re-enable them once setup is finished.

If that didn't help...

Try performing the setup on a different mobile device.

Why can't visitors hear me on my Spotlight Cam when I talk through the app?

If you're on an iPhone or iPad, check the microphone permissions on your device.

Select **Settings**, find Ring and select it. Lastly, make sure the switch next to **Microphone** is toggled on.

If you're on an Android device, go to Settings > Application/Apps > Application Manager > Ring > Permissions. Ensure everything here is on.

Why is my video and/or audio quality poor?

First, determine the cause. Remove your Spotlight Cam and bring it inside near your router. Open the Ring app, and press the Live View button, or trigger a motion event to see live video.

If you get good video quality near your router, you need to extend your Wi-Fi signal.

We recommend **Ring Chime Pro** to boost the signal to your Spotlight Cam.

Learn more at: ring.com/chime-pro

If video quality is still poor near your router, test your internet speed by selecting Device Health in the Ring app, then Test Your Wi-Fi.

The instructions in the app will help you diagnose and solve any issues related to poor video quality.

If I have two batteries in my Spotlight Cam, how do I know which one needs to be charged?

When your battery needs to be charged, the Ring app will notify you. To determine which battery needs to be charged, you will need to open the battery compartment and look for the red flashing light on the side closest to the hinge. This indicates that the battery in this compartment needs to be charged.

For additional help, visit:
ring.com/help

Or give us a call...

US 1 800 656 1918

Canada 1 855 300 7289

Mexico (D.F) 52 55 8526 5445

Worldwide +1 310 929 7085

For a list of all our customer
support numbers, visit:
ring.com/callus