

Lenovo ideapad 320

ideapad 320-14IAP/ideapad 320-14AST

ideapad 320-15IAP/ideapad 320-15AST

ideapad 320-15ABR

ideapad 320-15ABR Touch

User Guide



Read the safety notices and important tips in the included manuals before using your computer.

Lenovo™

Notes

- Before using the product, be sure to read *Lenovo Safety and General Information Guide* first.
- The latest electronic compliance and environmental information are available from the Lenovo compliance information Web sites.
 - To view compliance information go to:
<http://www.lenovo.com/compliance>.
 - To download environmental information go to:
<http://www.lenovo.com/ecodeclaration>.
- Some instructions in this guide may assume that you are using Windows® 10. If you are using another Windows operating system, some operations may be slightly different. If you are using other operating systems, some operations may not apply to you.
- The features described in this guide are common to most models. Some features may not be available on your computer or your computer may include features that are not described in this user guide.
- The illustrations used in this manual are for Lenovo ideapad 320-15ABR unless otherwise stated.
- The illustrations in this manual may differ from the actual product. The screenshots of operating system are for reference only. Please refer to the actual product.

Regulatory Notice

- For details, refer to **Guides & Manuals** at <http://support.lenovo.com>.

First Edition (February 2017)

© Copyright Lenovo 2017.

LIMITED AND RESTRICTED RIGHTS NOTICE: If data or software is delivered pursuant to a General Services Administration "GSA" contract, use, reproduction, or disclosure is subject to restrictions set forth in Contract No. GS-35F-05925.

Contents

Chapter 1. Getting to know your computer	1
Top view	1
Left-side view	5
Right-side view	9
Bottom view	11
Chapter 2. Starting to use Windows 10	12
Configuring the operating system for the first time	12
Operating system interfaces	12
Putting the computer to sleep or shutting it down	16
Connecting to a wireless network	18
Get help from Windows	19
Chapter 3. Recovery system	20
Lenovo OneKey Recovery system	20
Push-button reset	22
Chapter 4. Troubleshooting	25
Frequently asked questions	25
Troubleshooting	28
Appendix A. CRU instructions	31
Replacing the optical drive	32
Trademarks	35

Chapter 1. Getting to know your computer

■ ■ Top view

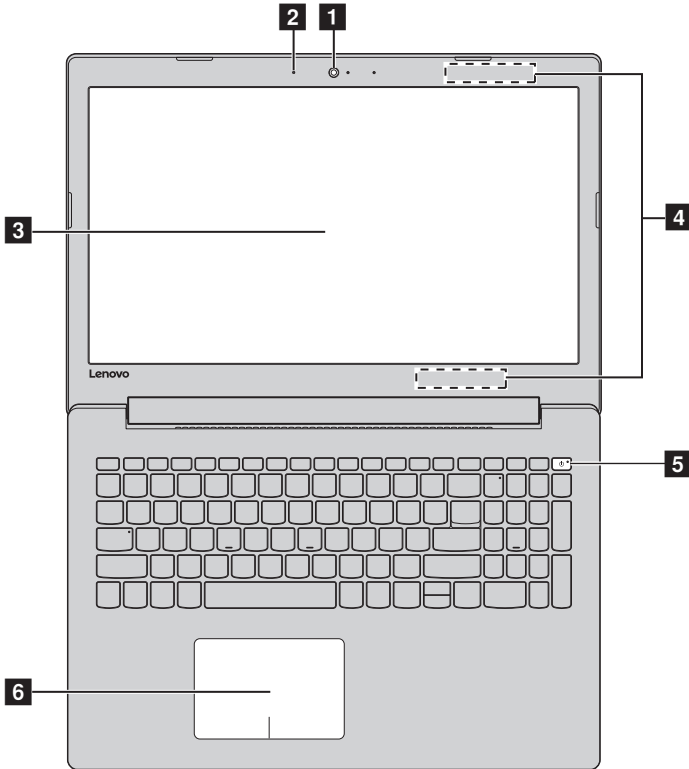

Note: The dashed areas indicate parts that are not visible externally.

⦿ Attention:

- Do *not* open the display panel beyond 170 degrees. When closing the display panel, be careful *not* to leave pens or any other objects in between the display panel and the keyboard. Otherwise, the display panel may be damaged.

Chapter 1. Getting to know your computer

- 1 Integrated camera** Use the camera for video communication.
- 2 Built-in microphone** Capture sound which can be used for video conferencing, voice narration, or audio recording.
- 3 Computer display** The LCD display with LED backlight provides brilliant visual output.
- 4 Wireless LAN antennas** Connect to a wireless LAN adapter to send and receive wireless radio signals.
- 5 Power Key** Press this key to turn on/off the computer.
When the computer is on, press and hold this key for more than 1 second, the computer will enter sleep mode, press and hold it for more than 4 seconds, the computer will be turned off.
- 6 Touch pad** The touch pad functions as a conventional mouse.
Touch pad: To move the pointer on the screen, slide your fingertip over the pad in the direction in which you want the pointer to move.
Touch pad buttons: The functions of the left/right side correspond to those of the left/right mouse button on a conventional mouse.









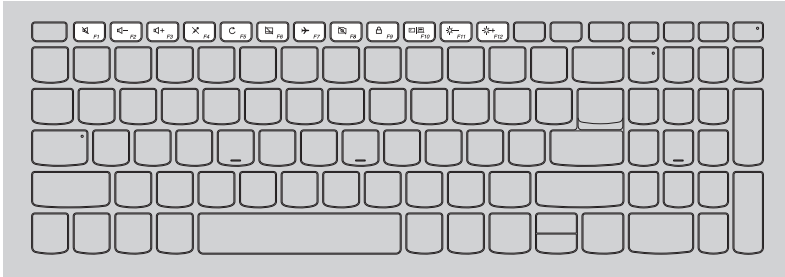



Note: You can enable/disable the touch pad by pressing F6 ()

■ Using the keyboard

Hotkeys

You can access certain system settings quickly by pressing the appropriate hotkeys.



	Mutes/unmutes the sound.		Enables/disables airplane mode.
	Decreases the volume level.		Enables/disables camera.
	Increases the volume level.		Locks/unlocks the LCD screen.
	Enables/disables microphone.		Enables the external projector or dangles the external display.
	Refreshes page.		Decreases display brightness.
	Enables/disables the touch pad.		Increases display brightness.

Note: If you changed the **Hotkey Mode** from **Enabled** to **Disabled** in the BIOS setup utility, you will need to press the Fn key in combination with the appropriate hotkey.

Chapter 1. Getting to know your computer

Function key combinations

Through the use of the function keys, you can change operational features instantly. To use this function, press and hold **Fn** **1**; then press one of the function keys **2**.

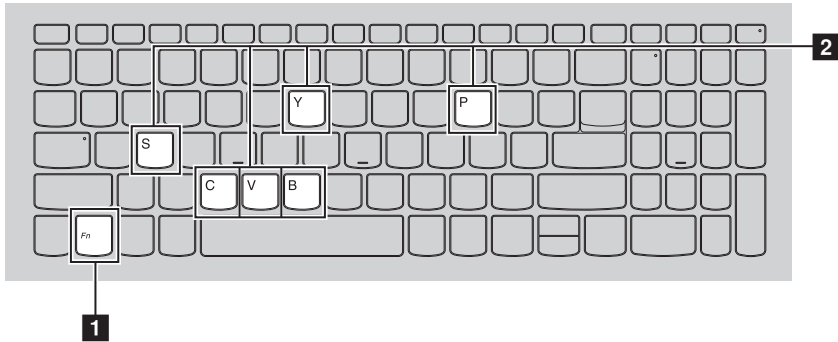

The following describes the features of each function key.

Fn + B:	Activates the break function.
Fn + P:	Activates the pause function.
Fn + C:	Enables/Disables the scroll lock.
Fn + Y:	Activates the system request.
Fn + S + V:	Set the battery Ship Mode.

■ ■ Left-side view

- Lenovo ideapad 320-14IAP/ideapad 320-15IAP/ideapad 320-14AST/ideapad 320-15AST

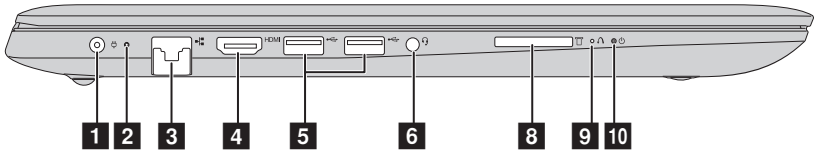

- Lenovo ideapad 320-15ABR/ideapad 320-15ABR Touch

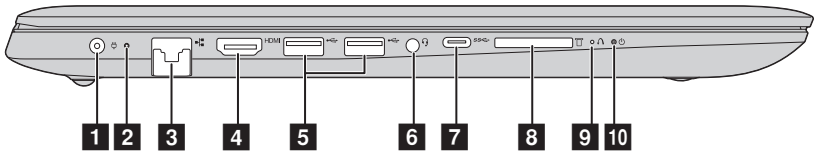

- 1 AC power adapter jack** Connects to the AC power adapter.

Chapter 1. Getting to know your computer

2 Battery/Charging status indicator

AC power adapter status	Indicator status	Meaning
Disconnected	Off	The computer is in sleep mode or turned off; The battery has more than 20% charge.
	Solid amber	The battery has between 5% and 20% charge.
	Fast blinking amber	The battery has between 0% and 5% charge.
Connected	Slow blinking amber	The battery is being charged. When battery charge reaches 20%, the blinking color changes to white.
	Slow blinking white	The battery has between 20% and 80% charge and is still charging. When the battery reaches 80% charge the light will stop blinking.
	Solid white	The battery has more than 80% charge, charging will continue until the battery is fully charged.

3 RJ-45 port Connects the computer to an Ethernet network.

4 HDMI port Connects to devices with HDMI input such as a TV or a display.

5 USB port Connects to USB devices.

Notes:

- For details, see “Connecting USB devices” on page 8.
- The black port supports USB 3.0.

Chapter 1. Getting to know your computer

- 6 Combo audio jack** Connects to headsets.

Notes:

- The combo audio jack does not support conventional microphones.
- The recording function may not be supported if third-party headphones or headsets are connected, due to different industry standards.

- 7 Type-C port (Lenovo ideapad 320-15ABR/ideapad 320-15ABR Touch only)** Type-C port supports:
- USB 3.1 (Gen1, Output 5V DC, 0.9A DC)

- 8 Memory card slot** Insert memory cards (not supplied) here.

Note: For details, see “Using memory cards (not supplied)” on page 10.

- 9 Novo button** When the computer is off, press this button to start the System Recovery or the BIOS setup utility, or to enter the boot menu.

- 10 Power status indicator** 

Indicator	Indicator status	Meaning
Power status indicator	On (solid white)	The computer is powered on.
	Blinking	The computer is in sleep mode.
	Off	The computer is powered off.

Chapter 1. Getting to know your computer

■ Connecting USB devices

You can connect a USB device to your computer by inserting its USB plug (Type A) into the USB port on your computer.

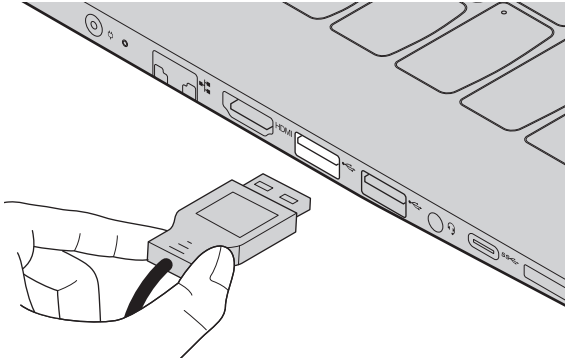

The first time you plug a USB device into a particular USB port on your computer, Windows automatically installs a driver for that device. After the driver has been installed, you can disconnect and reconnect the device without performing any additional steps.

Note: Typically, Windows detects a new device after it has been connected, and then installs the driver automatically. However, some devices may require you to install the driver before connecting. Check the documentation provided by the device's manufacturer before connecting the device.

Before disconnecting a USB storage device, make sure your computer has finished transferring data to that device. Click the **Safely Remove Hardware and Eject Media** icon in the Windows notification area to remove the device before disconnecting.

Note: If your USB device uses a power cord, connect the device to a power source before connecting it. Otherwise, the device may not be recognized.

■ ■ Right-side view

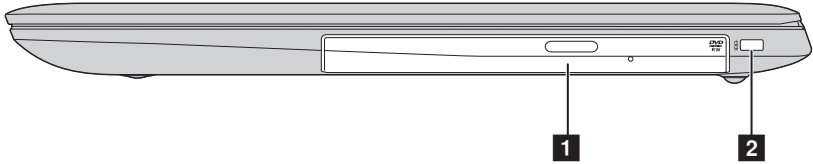

- 1 Optical disc drive** Reads/Burns optical discs.

Note: Some models are supplied with a dummy optical disc drive.

- 2 Kensington Security slot** Attach a security lock (not supplied) here to help protect your computer from theft and unauthorized use. You can attach a security lock to your computer to help prevent it from being removed without your permission. For details on installing the security lock, please refer to the instructions shipped with the security lock that you have purchased.

Notes:

- Before purchasing any security product, verify that it is compatible with this type of security keyhole.
- You are responsible for evaluating, selecting, and implementing the locking devices and security features. Lenovo offers no comment, judgment, or warranty regarding the function, quality, or performance of locking devices and security features.

Chapter 1. Getting to know your computer

■ Using memory cards (not supplied)

Your computer supports the following types of memory cards:

- Secure Digital (SD) card
- Secure Digital High Capacity (SDHC) card
- SD eXtended Capacity (SDXC) card
- MultiMediaCard (MMC)

Notes:

- Insert *only* one card in the slot at a time.
- This card reader does not support SDIO devices (e.g., SDIO Bluetooth, etc.).

Inserting a memory card

Insert the memory card until it touches the bottom of the slot.

Removing a memory card

Gently pull the memory card out of the memory card slot.

Note: Before removing the memory card, disable it by using the Windows safely remove hardware and eject media utility to avoid data corruption.

■ ■ Bottom view

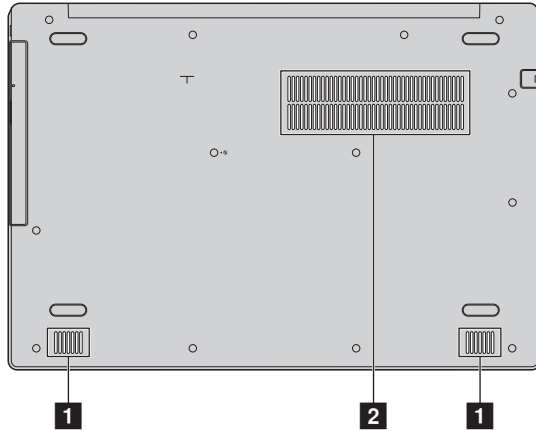

- 1 Speakers** Provide audio output.
- 2 Ventilation slots** Dissipate internal heat.

Note: Make sure that none of the ventilation slots are blocked, or else overheating of the computer may occur.

Chapter 2. Starting to use Windows 10

The ACTION CENTER

Select the ACTION CENTER icon  on the taskbar and the ACTION CENTER is displayed.

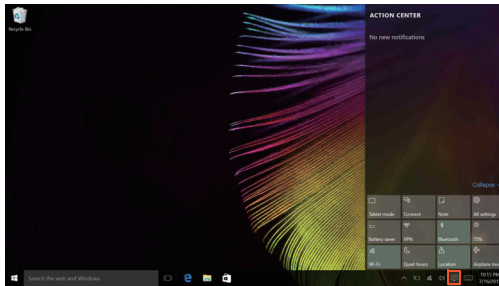

From the ACTION CENTER, you can examine important notifications from Windows and your apps. Moreover, you can change common settings quickly.

Task View in taskbar

In Windows 10, you can add a new desktop and switch between different desktops.

To add a new desktop, do the following:

- Click the Task View icon  in the taskbar area.

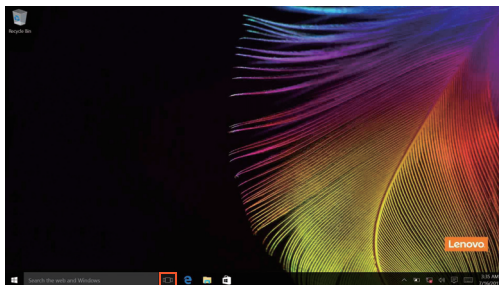

Chapter 2. Starting to use Windows 10

- Click **New desktop**.

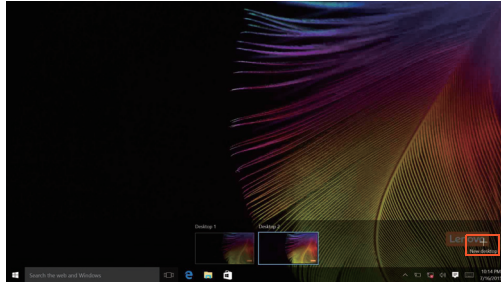

To switch between desktops, click the Task View icon , then select your desired desktop.

■ ■ Putting the computer to sleep or shutting it down

When you have finished working with your computer, you can put it to sleep or shut it down.

■ Putting your computer to sleep

If you will be away from your computer for only a short time, put the computer to sleep.

When the computer is in sleep mode, you can quickly wake it to resume use, bypassing the startup process.

To put the computer to sleep, do one of the following:

- Close the display lid.
- Press and hold the Power key for about 1 to 5 seconds.
- Move the cursor to the lower-left corner, and then select the Start button.

Select **Power**  → **Sleep**.

Note: Put your computer to sleep before you move it. Moving your computer while the hard disk drive is spinning can damage the hard disk, causing loss of data.

To wake up the computer, perform the following:

- Press any key on the keyboard.

■ Shutting down the computer

If you are not going to use your computer for a long time, shut it down. To shut down your computer, do one of the following:

- Move the cursor to the lower-left corner, and then select the Start button.

Select **Power**  → **Shut down**.



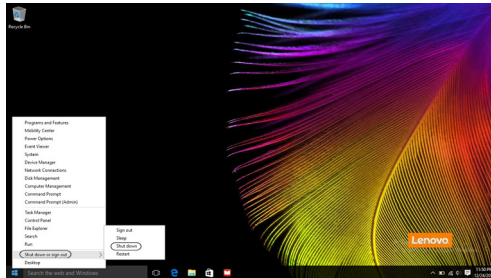

- Right-click the Start button in the lower-left corner and select **Shut down or sign out** → **Shut down**.



■ ■ Connecting to a wireless network

Enabling wireless connection

To enable wireless functions, do one of the following:

- Click the ACTION CENTER icon  in the notification area, and then deselect **Airplane mode**.
- Press  to disable airplane mode.
- Click **Settings**  → **Network & Internet** → **Airplane mode** to open the network configuration page. Then toggle the airplane mode switch to **Off**.

Connecting to a wireless network

After wireless has been enabled, the computer will automatically scan for available wireless networks and display them in the wireless network list. To connect to a wireless network, click the network name in the list, and then click **Connect**.

Note: Some networks require a network security key or passphrase for connection. To connect to one of those networks, ask the network administrator or the Internet service provider (ISP) for the security key or passphrase.

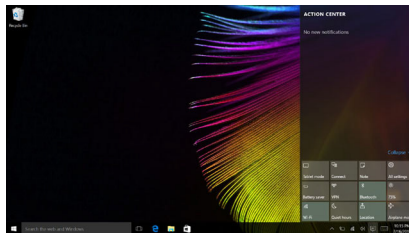

■ ■ Get help from Windows ---

If you have a problem with the operating system, see the Windows Get Started app. To open it, do the following:

- Move the cursor to the lower-left corner, and then select the Start button. Select **Get Started** from **All apps**.

Chapter 3. Recovery system

Lenovo provides **Lenovo OneKey Recovery system** or **Push-button reset** for system recovery, which depends on the pre-installed software. Refer to the actual product. You can perform either to start the system recovery.

■ ■ **Lenovo OneKey Recovery system**

The Lenovo OneKey Recovery system is software designed to back up and restore your computer. You can use it to restore the system partition to its original status in case of a system failure. You can also create user backups for easy restoration as required.

Notes:

- If your computer is preinstalled with a GNU/Linux operating system, OneKey Recovery system is not available.
- To utilize the features of the OneKey Recovery system, your hard disk already includes a hidden partition by default to store the system image file and the OneKey Recovery system program files. This default partition is hidden for security reasons, which explains why the available disk space is less than the stated capacity.

■ **Backing up the system partition**

You can back up the system partition to an image file. This image file can be used to restore the system partition. To back up the system partition:

- ❶ In Windows, press the Novo button or double-click OneKey Recovery icon to start the Lenovo OneKey Recovery system.
- ❷ Click **System Backup**.
- ❸ Select a back-up location and click **Next** to start the backup.

Notes:

- You can choose a back-up location on the local hard disk drive or an external storage device.
- Remove the removable hard disk drive before starting the Lenovo OneKey Recovery system. Otherwise, data from the removable hard disk drive might be lost.
- The back-up process may take a while.
- The back-up process is only available when Windows can be started normally.

■ Restoring

You can choose to restore the system partition to its original status or to a previously created back-up point. To restore the system partition:

- ① In Windows, press the Novo button or double-click OneKey Recovery icon to start the Lenovo OneKey Recovery system.
- ② Click **System Recovery**. The computer will restart to the recovery environment.
- ③ Follow the on-screen instructions to restore the system partition to its original status or to a previously created back-up point.

Notes:

- The recovery process is irreversible. Make sure to back up any data you wish to save on the system partition before starting the recovery process.
- The recovery process may take a while. So be sure to connect the AC power adapter to your computer during the recovery process.
- The above instructions should be followed when Windows can be started normally.

If Windows cannot be started, then follow the steps below to start the Lenovo OneKey Recovery system:

- ① Shut down the computer.
- ② Press the Novo button. From the **Novo Button Menu**, select **System Recovery** and press Enter.

Chapter 3. Recovery system

■ ■ Push-button reset

Push-button reset is a built-in recovery tool that enables users to restore their operating system to its original state. This preserves their data and important customizations, without the need to back up their data in advance. The following **Push-button reset** features are available to users from multiple locations within Windows:

Refreshing the computer

Fixes software problems by reinstalling the factory default configuration. This preserves the user's data, important settings, and any Windows Store apps previously purchased from the Windows Store.

Resetting the computer

Prepares the computer for recycling or transfer of ownership. This reinstalls the factory default configuration and returns all user data and applications to the state of their original Out-of-Box Experience (OOBE).

■ Using Push-button reset

Push-button reset can be launched using one of the following methods:

- Novo button:
 - Shut down the computer and wait at least five seconds. Press the Novo button and then select **System Recovery**.
- Settings:
 - **Settings** → **Update & security** → **Recovery** → **Advanced startup** → select **Restart now**.

For more instructions, see the Windows Help and Support file on your computer.

When I purchased my computer, it included a copy of Windows. How can I determine whether the copy of Windows is preinstalled by Lenovo?

On the outside of the sales package of your computer, you should find a label containing configuration information for your computer. Check the printed string next to **OS**. If it contains **Windows** or **WIN**, the copy of Windows was preinstalled by Lenovo.

What is the Recovery Partition?

If your computer is preinstalled with any version of Windows 10, the storage device of your computer contains a Recovery Partition. This

partition contains the image file of the preinstalled Windows operating system. In cases of system failure, you can use the Lenovo OneKey Recovery system or the Windows Reset feature to restore the operating system to its factory status.

Note: The Recovery Partition is not assigned a drive letter and cannot be accessed through Windows File Explorer.

I uninstalled a preinstalled software, but there is no significant increase in the free drive space.

The copy of Windows running on your computer may be Compact technology enabled. For computers with Compact technology enabled Windows, the majority of files needed for preinstalled software are installed on the Recovery Partition and won't be deleted through normal uninstallation.

What happens if I attempt to delete or modify the Recovery Partition?

Attention: Do *not* delete or modify the Recovery Partition on a Compact technology enabled computer.

If the Recovery Partition is deleted or modified, you may not be able to restore Windows to the factory status. For computer models on which Compact technology is enabled, deleting the Recovery Partition may cause Windows to fail to start.

How can I determine whether the Windows running on my computer is Compact technology enabled?

Compact technology is normally enabled on copies of Windows 10 Update running on SSD (or eMMC) -only computer models. To check your computer,

- 1 Right-click the Start button in the lower-left corner and select **Disk Management**.
- 2 The Disk Management program starts.

Chapter 3. Recovery system

If **Wim Boot** is labeled on the Windows partition (as illustrated), Compact technology is enabled on your copy of Windows.



Where can I find drivers for the various hardware devices of my computer?

If your computer is preinstalled with a Windows operating system, first check the installation program on the C partition of your hard disk. If you cannot find the drivers for all the hardware devices that you need there, download the drivers from the Lenovo consumer support website.

Note: The Lenovo support Web site contains the latest drivers.

Chapter 4. Troubleshooting

■ ■ Frequently asked questions

This section lists frequently asked questions by category.

■ Finding information

What safety precautions should I follow when using my computer?

The *Lenovo Safety and General Information Guide* which came with your computer contains safety precautions for using your computer. Read and follow all the precautions when using your computer.

Where can I find the hardware specifications for my computer?

You can find hardware specification for your computer on the printed flyers which came with your computer.

Where can I find warranty information?

For the warranty applicable to your computer, including the warranty period and type of warranty service, see the Lenovo limited warranty flyer that came with your computer.

■ Drivers and preinstalled software

Where are the installation discs for Lenovo preinstalled software (desktop software)?

Your computer does not come with installation discs for Lenovo preinstalled software. If you need to reinstall any preinstalled software, you can find the installation program on the D partition of your hard disk (for select models, on the C partition). If you cannot find the installation program there, you can also download it from the Lenovo consumer support website.

Where can I find drivers for the various hardware devices of my computer?

If your computer is preinstalled with a Windows operating system, Lenovo provides drivers for all the hardware devices that you need on the D partition of your hard disk (for select models, on the C partition). You can also download the latest device drivers from the Lenovo consumer support website.

Chapter 4. Troubleshooting

■ Recovery system

Where are the recovery discs?

Your computer did not come with recovery discs. Use the Lenovo OneKey Recovery system or Push-button reset if you need to restore the system to its factory status.

What can I do if the back-up process fails?

If you can start the backup but it fails during the back-up process, try the following steps:

- ❶ Close all open programs, and then restart the back-up process.
- ❷ Check to see if the destination media is damaged. Select another path and then try again.

When do I need to restore the system to its factory status?

Use this feature when the operating system fails to start up. If there is critical data on the system partition, back it up before starting recovery.

■ BIOS setup utility

What is the BIOS setup utility?

The BIOS setup utility is ROM-based software. It displays basic computer information and provides options for setting boot devices, security, hardware mode, and other preferences.

How can I start the BIOS setup utility?

To start the BIOS setup utility:

- ❶ Shut down the computer.
- ❷ Press the Novo button and then select **BIOS Setup**.

How can I change the boot mode?

There are two boot modes: **UEFI** and **Legacy Support**. To change the boot mode, start the BIOS setup utility and set boot mode to **UEFI** or **Legacy Support** on the boot menu.

When do I need to change the boot mode?

The default boot mode for your computer is **UEFI** mode. If you need to install a legacy operating system, such as Windows, Linux or Dos, etc (that is, any operating system before Windows 8) on your computer, you must change the boot mode to **Legacy Support**. The legacy operating system, such as Windows, Linux or Dos, etc cannot be installed if you don't change the boot mode.

■ Getting help

How can I contact the customer support center?

See “Chapter 3. Getting help and service” of *Lenovo Safety and General Information Guide*.

■ ■ Troubleshooting

Display problems

When I turn on the computer, nothing appears on the screen.

- If the screen is blank, make sure that:
 - The AC power adapter is connected to the computer, and the power cord is plugged into a working electrical outlet.
 - The computer power is on. Press the Power key again for confirmation.
- If these items are set correctly, and the screen remains blank, have the computer serviced.

When I turn on the computer, only a white cursor appears on a blank screen.

- Restore backed-up files to your Windows environment or the entire contents of your hard disk to its original factory contents using the Lenovo OneKey Recovery system or Push-button reset. If you still see only the cursor on the screen, have the computer serviced.

The screen goes blank while the computer is on.

- Your power management is enabled. Perform the following to resume from sleep mode:
 - Press any key on the keyboard.

Sleep problems

The critical low-battery error message appears, and the computer immediately turns off.

- The battery power is getting low. Connect the AC power adapter to the computer.

The computer enters sleep mode immediately after Power-on.

- Make sure that:
 - The battery is charged.
 - The operating temperature is within the acceptable range. See “Chapter 2. Use and care Information” in the *Lenovo Safety and General Information Guide*.

Note: If the battery is charged and the temperature is within range, have the computer serviced.

The computer does not return from sleep mode and the computer does not work.

- If your computer is in sleep mode, connect the AC power adapter to the computer, then press the Windows button or the Power key.
- If the system still does not return from sleep mode, your system has stopped responding, and you cannot turn off the computer; reset the computer. Unsaved data may be lost. To reset the computer, press and hold the Power key for eight seconds or more. If the computer still does not reset, remove the AC power adapter.

Display panel problems

The screen is blank.

- Do the following:
 - If you are using the AC power adapter or the battery, and the battery status indicator is on, press **F12** () to make the screen brighter.
 - If the power indicator is blinking, press the Power key to resume from sleep mode.
 - If the problem persists, follow the solution in the next problem “The screen is unreadable or distorted.”

The screen is unreadable or distorted.

- Make sure that:
 - The screen resolution and color quality are correctly set.
 - The monitor type is correct.

Incorrect characters appear on the screen.

- Is the operating system or programs installed correctly? If they are installed and configured correctly, have the computer serviced.

Sound problems

No sound can be heard from the speakers even when the volume is turned up.

- Make sure that:
 - The Mute function is off.
 - The combo audio jack is not being used.
 - Speakers are selected as the playback device.

Chapter 4. Troubleshooting

Battery problems

Your computer shuts down before the battery status indicator shows empty.

-or-

Your computer operates after the battery status indicator shows empty.

- Recharge the battery.

Other problems

Your computer does not respond.

- To turn off your computer, press and hold the Power key for eight seconds or more. If the computer still does not respond, remove the AC power adapter.
- Your computer might lock when it enters sleep mode during a communication operation. Disable the sleep timer when you are working on the network.

The connected external device does not work.

- Do *not* connect or disconnect any external device cables other than USB while the computer power is on. Otherwise, you might damage your computer.
- When using high power consumption external devices, such as an external USB optical drive, use an external device power adapter. Otherwise, the device may not be recognized, or the system may shut down as a result.

Appendix A. CRU instructions

Customer Replaceable Units (CRUs) are parts that can be upgraded or replaced by the customer. If a CRU is determined to be defective during the warranty period, a replacement CRU will be provided to the customer. Customers are responsible for installing the self-service CRUs for this product. Customers also can install optional-service CRUs, which might require some technical skills or tools, or request that a technician install the optional-service CRU under the terms of the applicable warranty service type for your country or region.

Notes:

- The illustrations used in this chapter are of the Lenovo ideapad 320-15ABR, unless otherwise stated.
- The illustrations in this manual might differ from the actual product. Please refer to the actual product.
- The CRU service is only applicable to certain countries.

CAUTION:

Set the built-in battery in Ship Mode before replacing a CRU or sending your computer for service.

- Turn off the computer and disconnect the AC adapter.
- Press Fn + S + V.
- Press the Power button to verify if Ship Mode has been set.

Note: When set in Ship Mode, the battery does not supply power to the computer. To awake the battery from Ship Mode, connect the AC adapter to your computer.

Appendix A. CRU instructions

■ ■ Replacing the optical drive

To replace the optical drive, do the following:

- ❶ Turn off the computer. Disconnect the AC power adapter and all cables from the computer.
- ❷ Close the computer display and turn the computer over.
- ❸ Remove the screw **❶**.

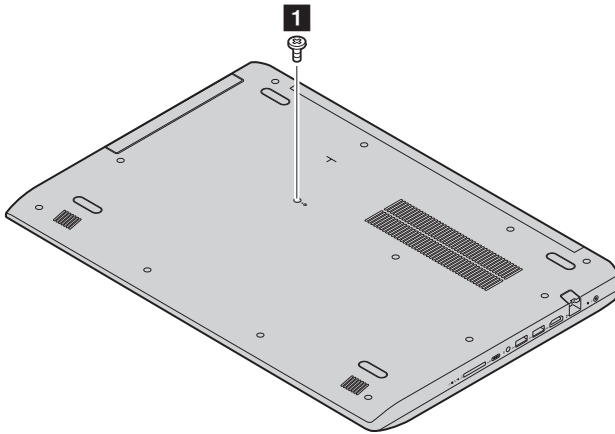

- 4 Gently pull the optical drive out from its cavity **2**.

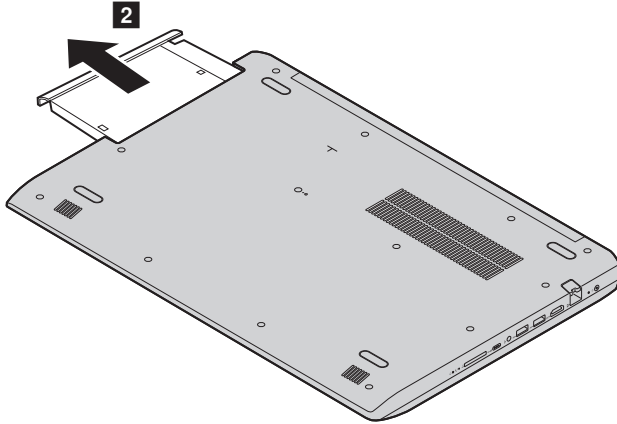

- 5 Insert a new optical drive and tighten the screw to secure the drive.
- 6 Turn the computer over again.
- 7 Connect the AC power adapter and the cables to the computer.

Appendix A. CRU instructions

The following table provides a list of CRUs for your computer, and informs you of where to find replacement instructions.

Self-service CRUs

	Safety, Warranty, and Setup Guide	User Guide
AC power adapter	×	
Optical drive		×

Trademarks

The following terms are trademarks or registered trademarks of Lenovo in the United States, other countries, or both.

Lenovo

Microsoft and Windows are trademarks of Microsoft Corporation in the United States, other countries, or both.

Other company, products, or service names may be trademarks or service marks of others.

