

acer

P249-M/ P249-MG



TravelMate P2

USER'S MANUAL

© 2016. All Rights Reserved.

TravelMate P2 Series

Covers: P249-MG / P249-M

This revision: June 2016

Sign up for an Acer ID and enjoy great benefits

1. Ensure you are connected to the Internet.
2. Open www.acer.com and select your country.
3. Click **REGISTER A PRODUCT**.
4. Sign up for an Acer ID or sign in if you already have an Acer ID.

Register your Acer product

After we receive your product registration, you will be sent a confirmation email with important data. Keep this email in a safe place.

Manage your registered products

Once you have completed the registration process, you can log onto **account.acer.com** using your Acer ID and password to see and manage all your registered products.

Note: *It may take a few days for your information to be updated to the database.*



Important

This manual contains proprietary information that is protected by copyright laws. The information contained in this manual is subject to change without notice. Images provided herein are for reference only and may contain information or features that do not apply to your computer. Acer Group shall not be liable for technical or editorial errors or omissions contained in this manual.

Model number: _____

Serial number: _____

Date of purchase: _____

Place of purchase: _____

TABLE OF CONTENTS

Register your Acer product	2	Fingerprint Registration*	40
Manage your registered products	2	Data Protection	41
First things first	6	Data Removal	41
Your guides	6	Securing your computer	42
Basic care and tips for using your computer	7	Using a computer security lock	42
Turning your computer off	7	Using passwords	42
Taking care of your computer	7	Entering passwords	43
Taking care of your AC adapter	8	BIOS utility	44
Cleaning and servicing	8	Boot sequence	44
Your Acer notebook tour	9	Setting passwords	44
Screen view	9	Power management	45
Keyboard view	10	Saving power	45
Left view	11	Battery pack	47
Information on USB 3.0	11	Battery characteristics	47
Right view	12	Charging the battery	47
Base view	13	Optimizing battery life	48
Using the keyboard	14	Checking the battery level	49
Lock keys	14	Battery-low warning	49
Hotkeys	14	Traveling with your computer	50
Windows keys	15	Disconnecting from the desktop	50
Using the Precision Touchpad	17	Moving around	50
Touchpad gestures	17	Preparing the computer	50
Changing touchpad settings	18	What to bring to meetings	51
Recovery	21	Taking the computer home	51
Creating a factory default backup	21	Preparing the computer	51
Backing up your wireless and LAN drivers	24	What to take with you	52
Restoring your computer	24	Special considerations	52
Reset this PC and keep my files	24	Setting up a home office	52
Reset this PC and remove everything	25	Traveling with the computer	53
Using a Bluetooth connection	28	Preparing the computer	53
Enabling and disabling Bluetooth	28	What to take with you	53
Enable Bluetooth and add a device	28	Special considerations	53
Connecting to the Internet	30	Traveling internationally	53
Connecting to a wireless network	30	Preparing the computer	54
Connecting to a wireless LAN	30	What to bring with you	54
Connecting with a cable	34	Special considerations	54
Built-in network feature	34	Memory card reader	56
Connecting to a cellular network	34	Connectivity options	56
Acer Bluelight Shield	35	Video and audio connectors	58
Acer ProShield	37	Universal Serial Bus (USB)	59
Overview	37	HDMI	60
Setting up Acer ProShield	37	Frequently asked questions	62
Personal Secure Drive	39	Requesting service	64
Credential Manager	40	Tips and hints for using Windows 10	65
		How do I get to Start?	65
		How do I turn off my computer?	65
		How do I unlock my computer?	65

How do I set the alarm?	67
Where are my apps?.....	68
What is a Microsoft ID (account)?	68
How do I check for Windows updates?	69
Where can I get more information?.....	69
Troubleshooting	70
Troubleshooting tips.....	70
Error messages.....	70

Internet and online security	72
First steps on the net	72
Protecting your computer.....	72
Choose an Internet Service Provider	72
Network connections.....	74
Surf the Net!.....	76
Security	76
Playing Blu-Ray or DVD movies	83

Getting started...

In this section you will find:

- Useful information on caring for your computer and your health
- Where to find the power button, ports and connectors
- Tips and tricks for using the touchpad and keyboard
- How to create recovery backups
- Guidelines for connecting to a network and using Bluetooth
- Information on using Acer's bundled software

FIRST THINGS FIRST

We would like to thank you for making this Acer notebook your choice for meeting your mobile computing needs.

Your guides

To help you use your Acer notebook, we have designed a set of guides:

First off, the **Setup Guide** (or **Setup Poster**) helps you get started with setting up your computer.

The **Quick Guide** introduces you to the basic features and functions of your new computer. For more on how your computer can help you to be more productive, please refer to the **User's Manual**. This guide contains detailed information on such subjects as system utilities, data recovery, expansion options and troubleshooting.

There are two ways to download the **User's Manual**. You must first be connected to the internet.

1. Open **Acer ControlCenter** from the desktop and select *My System* > *Summary* and click **User's Manual** to download the **User's Manual**.
2. Click on the link under *Support*.
 1. The link will open the Acer Service & Support webpage.
 2. From this page you can download and install the Acer identification tool that will automatically detect your computer's serial number and SNID and allow you to copy it to the clipboard.
 3. Scroll down to *Drivers and Manuals* and search for your model by pasting in or manually entering the serial number, SNID, or product model.
 4. Once you have found your product model, select **Documents** and select your language to download the **User's Manual**.

Basic care and tips for using your computer

Turning your computer off

To turn the power off, do any of the following:

- Use the Windows shutdown command: Press the *Windows key* or select the *Windows Start button*, select **Power > Shut down**.
- Right-click the *Windows Start button* > **Shut down or sign out > Shut down**.

If you need to power down the computer for a short while, but don't want to completely shut it down, you can put it to *Sleep* by doing any of the following:

- Press the power button.
- Press the sleep hotkey.
- Press the *Windows key* or select the *Windows Start button*, select **Power > Sleep**.
- Right-click the *Windows Start button* > **Shut down or sign out > Sleep**.



Note

If you cannot power off the computer normally, press and hold the power button for more than four seconds to shut down the computer. If you turn off the computer and want to turn it on again, wait at least two seconds before powering up.

Taking care of your computer

Your computer will serve you well if you take care of it.

- Do not expose the computer to direct sunlight. Do not place it near sources of heat, such as a radiator.
- Do not expose the computer to temperatures below 0° C (32° F) or above 50° C (122° F).
- Do not subject the computer to magnetic fields.
- Do not expose the computer to rain or moisture.
- Do not spill water or any liquid on the computer.
- Do not subject the computer to heavy shock or vibration.

- Do not expose the computer to dust or dirt.
- Never place objects on top of the computer.
- Do not slam the computer display when you close it.
- Never place the computer on uneven surfaces.

Taking care of your AC adapter

Here are some ways to take care of your AC adapter:

- Do not connect the adapter to any other device.
- Do not step on the power cord or place heavy objects on top of it. Route the power cord and any cables away from where people walk.
- When unplugging the power cord, do not pull on the cord itself but pull on the plug.
- The total ampere ratings of the equipment plugged in should not exceed the ampere rating of the cord if you are using an extension cord. Also, the total current rating of all equipment plugged into a single wall outlet should not exceed the fuse rating.

Cleaning and servicing

When cleaning the computer, follow these steps:

1. Turn off the computer.
2. Disconnect the AC adapter.
3. Use a soft, moist cloth. Do not use liquid or aerosol cleaners.

If your computer is dropped or visibly damaged, or does not work normally, please contact your nearest authorized Acer service center. For more information, please [see Frequently asked questions on page 62](#).



YOUR ACER NOTEBOOK TOUR

After setting up your computer as illustrated in the Setup Guide, let us show you around your new Acer computer.

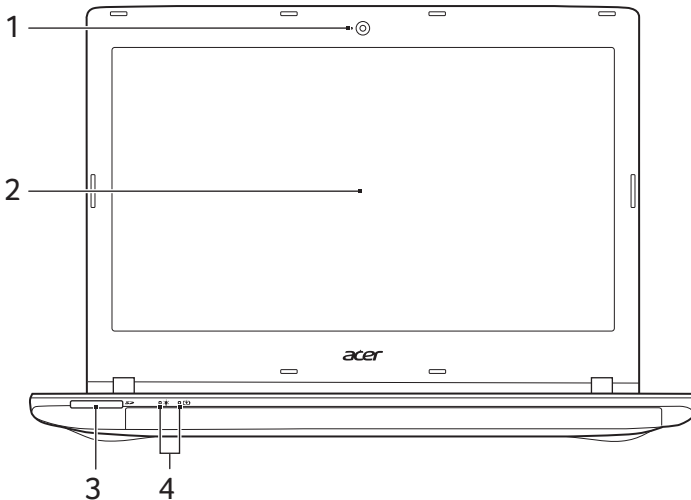
Screen view



#	Icon	Item	Description
1		Webcam	Web camera for video communication. <i>A light next to the webcam indicates that the webcam is active.</i>
2		Screen	Displays computer output.
3		SD card reader	Accepts one Secure Digital (SD or SDHC) card. <i>Only one card can operate at a time.</i>

#	Icon	Item	Description
		Power indicator	Indicates the computer's power status.
4		Battery indicator	Indicates the computer's battery status. Charging: The light shows amber when the battery is charging. Fully charged: The light shows blue when in AC mode.

Keyboard view

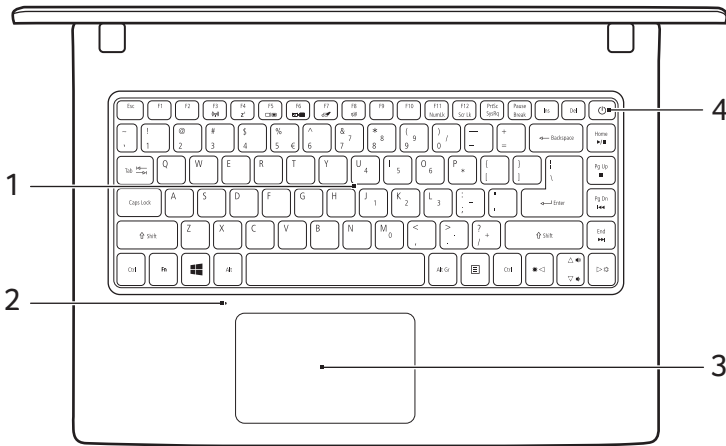



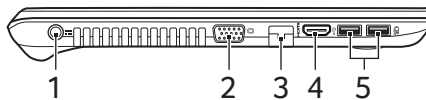

#	Icon	Item	Description
1		Keyboard	For entering data into your computer. See "Using the keyboard" on page 14.
2		Microphone	Internal digital microphone for sound recording.

#	Icon	Item	Description
3		Touchpad	Touch-sensitive pointing device. <i>The touchpad and selection buttons form a single surface.</i> <i>Press down firmly on the touchpad surface to perform a left click.</i> <i>Press down firmly on the lower right corner to perform a right click.</i>
4		Power key	Turns the computer on and off.

Left view







#	Icon	Item	Description
1		DC-in jack	Connects to an AC adapter.
2		External display (VGA) port	Connects to a display device (e.g., external monitor, LCD projector).
3		Ethernet (RJ-45) port	Connects to an Ethernet 10/100/1000-based network. <i>Pull the lip down to open the port fully.</i>
4		HDMI port	Supports high-definition digital video connections.
5		USB ports	Connect to USB devices.

Information on USB 3.0

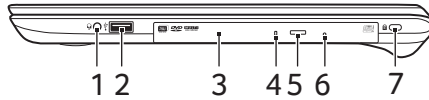
- USB 3.0 compatible ports are blue.
- Compatible with USB 3.0 and earlier devices.
- For optimal performance, use USB 3.0-certified devices.
- Defined by the USB 3.0 specification (SuperSpeed USB).

Right view



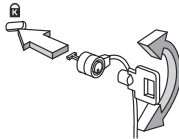

#	Icon	Item	Description
1		Headset/ speaker jack	Connects to audio devices (e.g., speakers, headphones) or a headset with microphone.
2		USB port	Connects to USB devices.
3		Optical drive	Internal optical drive; accepts CDs or DVDs.
4		Optical disk access indicator	Lights up when the optical drive is active.
5		Optical drive eject button	Ejects the optical disk from the drive.
6		Emergency eject hole	Ejects the optical drive tray when the computer is turned off. <i>Carefully insert a straightened paper clip to eject the optical drive tray.</i>
7		Kensington lock slot	Connects to a Kensington-compatible computer security lock. <i>Wrap the computer security lock cable around an immovable object such as a table or handle of a locked drawer.</i> <i>Insert the lock into the notch and turn the key to secure the lock.</i> <i>Keyless models are also available.</i>

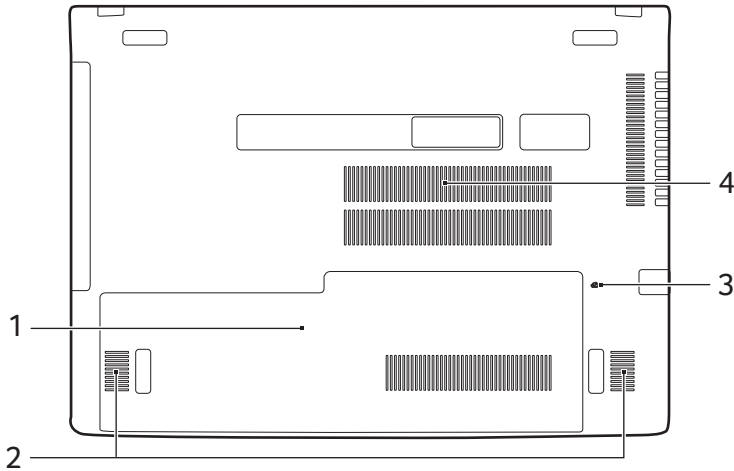

Base view



#	Icon	Item	Description
1		Main storage compartment	Houses the computer's main storage. <i>You may upgrade your computer's main storage. Acer recommends asking an approved service center to do this.</i>
2		Memory compartment	Houses the computer's memory. <i>You may upgrade your computer's memory. Acer recommends asking an approved service center to do this.</i>
2		Speakers	Deliver stereo audio output.
3		Battery reset pinhole	Simulates removing and reinstalling the battery. <i>Insert a paperclip into the hole and press for four seconds.</i>
4		Ventilation and cooling fan	Allows the computer to stay cool. <i>Do not cover or obstruct the openings.</i>

USING THE KEYBOARD

The keyboard has full-sized keys and a separate numeric keypad, separate cursor, lock, Windows, function and special keys.

Lock keys



The keyboard has three lock keys which you can toggle on and off.











Lock key	Description
Caps Lock	When Caps Lock is on, all alphabetic characters typed are in uppercase.
Num Lock	When Num Lock is on, the keypad is in numeric mode. The keys function as a calculator (complete with the arithmetic operators +, -, *, and /). Use this mode when you need to do a lot of numeric data entry.
Scroll Lock <Fn> + <F12>	When Scroll Lock is on, the screen moves one line up or down when you press the up or down arrow keys respectively. Scroll Lock does not work with some applications.

Hotkeys

The computer employs hotkeys or key combinations to access most of the computer's controls like screen brightness and volume output.

To activate hotkeys, press and hold the <Fn> key before pressing the other key in the hotkey combination.

Hotkey	Icon	Function	Description
<Fn> + <F3>		Airplane mode	Turns on / off the computer's network devices.
<Fn> + <F4>		Sleep	Puts the computer in Sleep mode.
<Fn> + <F5>		Display toggle	Switches display output between the display screen, external monitor (if connected) and both.

Hotkey	Icon	Function	Description
<Fn> + <F6>		Display off	Turns the display screen backlight off to save power. Press any key to return.
<Fn> + <F7>		Touchpad toggle	Turns the built-in touchpad on and off.
<Fn> + <F8>		Speaker toggle	Turns the speakers on and off.
<Fn> + <F11>		NumLk	Turns the embedded numeric keypad on or off.
<Fn> + <F12>		Scr Lk	Turns Scroll Lock on or off.
<Fn> + <▷>		Brightness up	Increases the screen brightness.
<Fn> + <◁>		Brightness down	Decreases the screen brightness.
<Fn> + <△>		Volume up	Increases the sound volume.
<Fn> + <▽>		Volume down	Decreases the sound volume.
<Fn> + <Home>		Play/Pause	Play or pause a selected media file.
<Fn> + <Pg Up>		Stop	Stop playing the selected media file.
<Fn> + <Pg Dn>		Previous	Return to the previous media file.
<Fn> + <End>		Next	Jump to the next media file.

Windows keys

The keyboard has two keys that perform Windows-specific functions.

Key	Description
 Windows key	Pressed alone it returns to the Start screen or to return to the last open app. It can also be used with other keys for special functions, please check Windows Help.

Key	Description
 Application key	This key has the same effect as clicking the right mouse button; it opens the application's context menu.

USING THE PRECISION TOUCHPAD

The touchpad controls the arrow  (or 'cursor') on the screen. As you slide your finger across the touchpad, the cursor will follow this movement. The Precision Touchpad (PTP) is designed to provide a more uniform, smooth, and accurate touchpad experience. Many applications support precision touchpad gestures that use one or more fingers, however, some gestures may not be supported by the specific application or program you are using.

Touchpad gestures

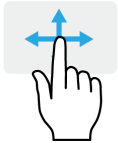

Single-finger slide

Slide a finger across the touchpad to move the cursor.



Single-finger press or tap

Press the touchpad down, or lightly tap the touchpad with your finger, to perform a 'click', which will select or start an item. Quickly repeat the tap to perform a double tap or 'double click'.



Two-finger press

Lightly tap the touchpad with two fingers to perform a  'right click'. In the *Start* screen, this will toggle the app commands. In most apps this will open a context menu related to the selected item.



Two-finger slide

Swiftly scroll through web pages, documents and playlists by placing two fingers on the touchpad and moving both in any direction.



Two-finger pinch

Zoom in and out of photos, maps and documents with a simple finger-and-thumb gesture.



Three-finger press

Lightly tap the touchpad with three fingers to open Cortana (if your computer supports Cortana) or open the *Action Center* (if your computer does not support Cortana).

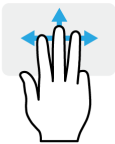

Three-finger swipe

Swipe across the touchpad with three fingers.

- Swipe up to open *Task View*. Move the cursor over a window and tap the touchpad to select that window, or swipe downwards to exit *Task View*.
- Swipe down to minimize all open windows and show *Desktop*; swipe upwards to restore the minimized windows.
- Swipe left or right to switch between open windows.

The precision touchpad includes added technology features that help recognize and prevent unintentional gestures such as accidental taps, gestures, and pointer movement.



Note

The touchpad is sensitive to finger movement; the lighter the touch, the better the response. Please keep the touchpad and your fingers dry and clean.

Changing touchpad settings

To change the touchpad settings to suit your personal requirements, please do the following.

1. In the icon tray in the lower right-hand corner of the screen, select the *Notifications* icon to open the *Notifications* pane.

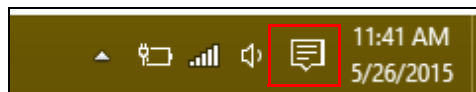

2. Select **All settings**.

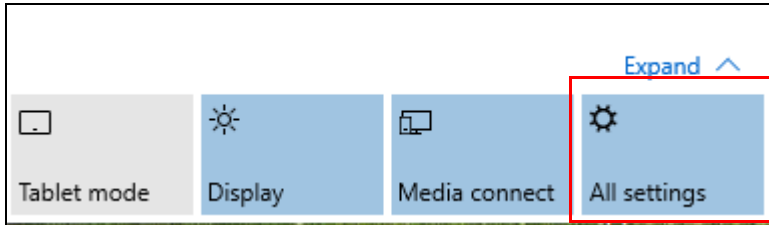

3. Select **Devices > Mouse & touchpad**.

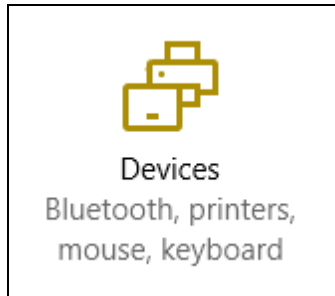

4. Now you can adjust the settings to suit your personal needs. You can change the primary button for left- or right-handed use, turn the touchpad off if you prefer to use a mouse, or set a delay to prevent

the cursor from moving if you accidentally tap the touchpad with your palm while working. Scroll down to see more settings.

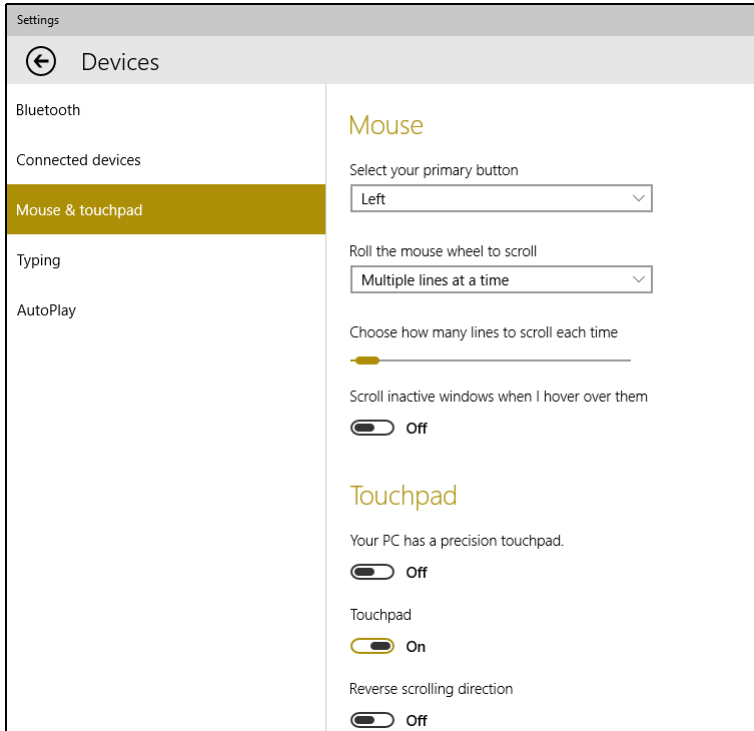

RECOVERY

If you are having trouble with your computer, and the frequently asked questions ([see Frequently asked questions on page 62](#)) do not help, you can recover your computer.

This section describes the recovery tools available on your computer. Acer provides *Acer ControlCenter*, which allows you to reset your PC, refresh your PC, or create a factory default backup.



Note

Acer ControlCenter is only available with a pre-installed Windows operating system.



Important

We recommend that you create a Factory Default Backup as soon as possible. In certain situations a full recovery will require a USB recovery backup.

Creating a factory default backup

Backup allows you to quickly and easily back up your operating system, installed apps and data.

1. From *Start*, select **All apps** then **Acer**. Select **Acer Recovery Management** in the list of Acer apps.



Note

Since the recovery backup requires at least 8 GB of storage after formatting, it is recommended to use a USB drive with a capacity of 16 GB or larger.

2. Select the **Backup** tab and click **Get Started** for **Create Factory Default Backup** to open the **Recovery Drive** window.

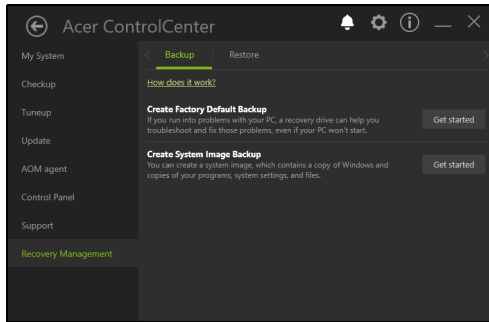

3. Make sure **Backup system files to the recovery drive** is selected and click **Next**.

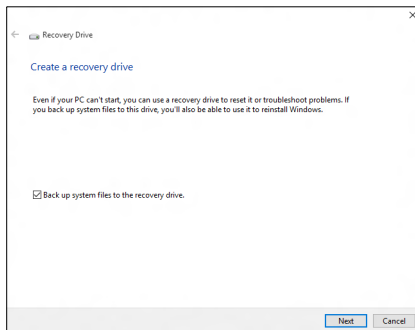

4. Plug in the USB drive and wait for the PC to detect the USB drive then click **Next**.

- *Since the recovery backup requires at least 8 GB of storage after formatting, it is recommended to use a USB drive with a capacity of 16 GB or larger.*

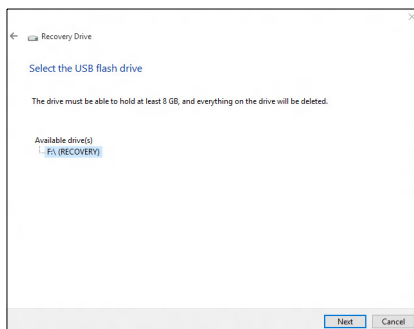

5. Everything on the drive will be deleted. Click **Create** to continue.
6. You will be shown the backup progress on the screen.
7. Follow the process until it completes.
8. After creating the recovery backup, you can choose to delete the recovery information on your computer. If you delete this information, you can only use the USB recovery backup to restore your computer, if you lose or erase the USB drive, you cannot restore your computer.
9. Unplug the USB drive and label it clearly.



Important

Write a unique, descriptive label on the backup, such as 'Windows Recovery Backup'. Make sure you keep the backup in a safe place that you will remember.

Backing up your wireless and LAN drivers

Back up your wireless and LAN drivers. You can use these backups to install the wireless and LAN drivers if you install another operating system.

1. From *Start*, select **All apps** then **Acer**. Select **Acer Recovery Management** in the list of Acer apps.
2. Select the *Backup* tab and click **Get started** for *Backup wireless and LAN drivers*. Choose a folder to save your drivers and select **OK**.

Restoring your computer

Recovery Management allows you to quickly and easily restore your computer back to its default status. You can choose to keep your files or remove them before reinstalling Windows.

Reset this PC and keep my files

1. From *Start*, select **All apps** then **Acer**. Select **Acer Recovery Management** in the list of Acer apps.
2. Select the *Restore* tab and click **Get started** to *Choose an option*.

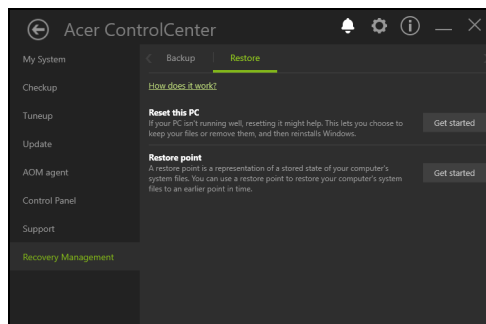

3. Select **Keep my files** to refresh your PC and reinstall your operating system without removing your personal files. Click **Next** to continue.

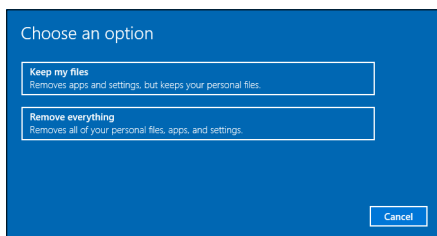

Important

If you have apps installed on your PC, they will be removed.

4. Resetting the PC will reinstall Windows, change settings back to their factory defaults and remove all preinstalled apps and programs without removing your personal files. Click **Reset** to continue.

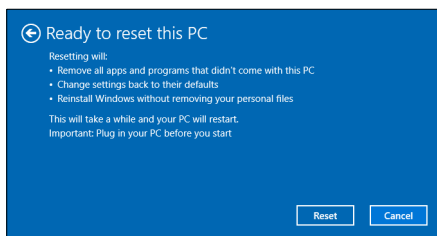

5. You will be shown the reset progress on the screen. The screen will turn off during the reset process.
6. The screen will turn back on when it is installing Windows. Your PC will restart several times during the reset process.
7. Follow the process until it completes.
8. When your PC has completed the reset process, Windows will have been reset back to its factory default settings without removing your personal files.

Reset this PC and remove everything

1. From *Start*, select **All apps** then **Acer**. Select **Acer Recovery Management** in the list of Acer apps.

2. Select the *Restore* tab and click **Get Started** to *Choose an option*.

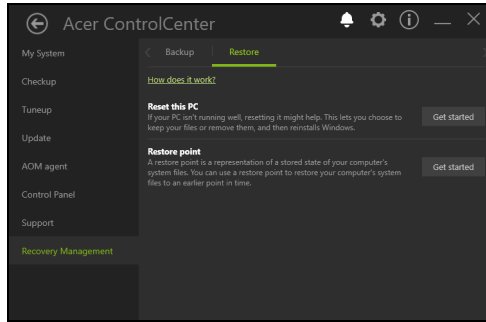

3. Select **Remove everything** to reset your PC back to its factory default. This process will reinstall your operating system and remove all of your personal files, apps, and settings.

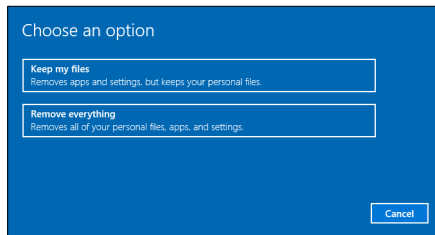

4. Select **Just remove my files** if you are keeping your computer. This will be quicker, but less secure. Files may still be recovered with a file recovery program.
Select **Remove files and clean the drive** if you are not keeping

your computer. This process will take longer, but will be more secure.



Warning

Selecting "**Remove files and clean the drive**" will remove all of your personal files and accounts, along with pre-existing drivers that may affect your Windows installation.

5. Click **Reset** to continue.

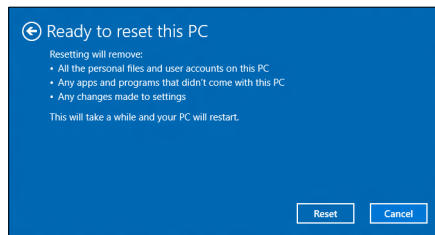

6. You will be shown the reset progress on the screen. The screen will turn off during the reset process.
7. The screen will turn back on when it is installing Windows. Your PC will restart several times during the reset process.
8. Follow the process until it completes.
9. When your PC has completed the reset process, Windows will use factory default settings.

USING A BLUETOOTH CONNECTION

Bluetooth is a technology enabling you to transfer data wirelessly over short distances between many different types of devices. Bluetooth-enabled devices include computers, cell phones, tablets, wireless headsets, and keyboards.

To use Bluetooth, you must ensure the following:

1. Bluetooth is enabled on both devices.
2. Your devices are "paired" (or connected).

Enabling and disabling Bluetooth

The Bluetooth adapter must be enabled on both devices. For your computer, this may be an external switch, a software setting, or a separate Bluetooth dongle plugged into the computer's USB port (if no internal Bluetooth adapter is available).



Note

Please check your devices owner's manual to determine how to turn on its Bluetooth adapter.

Enable Bluetooth and add a device

Every new device must first be "paired" with your computer's Bluetooth adapter. This means it must first be authenticated for security purposes. You only need to pair once. After that, simply turning on the Bluetooth adapter of both devices will connect them.

Bluetooth on your computer is disabled by default. To enable your computer's Bluetooth adapter, do the following:

1. Press the *Windows key* or select the *Windows Start button* > **Settings** > **Devices** > **Bluetooth**, and click the toggle under **Bluetooth** to enable/disable it.
2. Your computer will automatically start searching for devices, as well as make itself visible to other devices.

3. Select the device you wish to pair from the list of discovered devices, and select **Pair**.

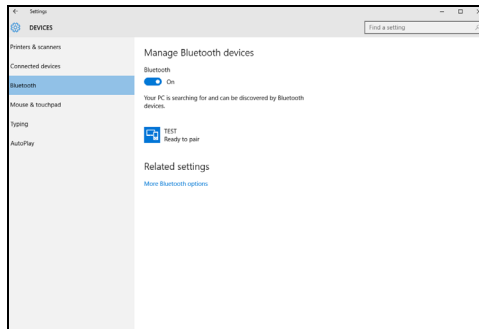

4. A code displays on your computer, which should match the code displayed on your device. Select **Yes**. Then, accept the pairing from your device.

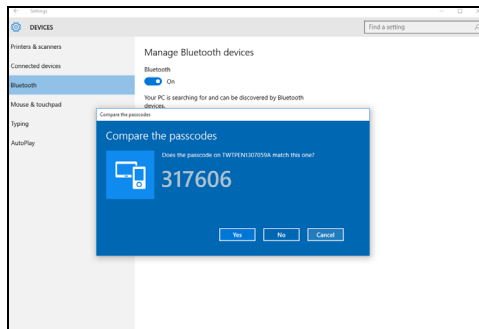

Note

Some devices using older versions of the Bluetooth technology require both devices to enter a PIN. In the case of one of the devices not having any inputs (as in a headset), the passcode is hardcoded into the device (usually "0000" or "1234"). Consult your device's user manual for more information.

You can also enter the Bluetooth settings by selecting the *Notifications* icon in the lower right-hand corner of the screen to open the *Notifications* pane. From here, you can enable or disable Bluetooth or right-click on **Bluetooth** > **Go to settings** to enter the Bluetooth settings.

CONNECTING TO THE INTERNET

This chapter includes general information on types of connections, and getting connected to the internet. Some of this information may not apply to your computer. For detailed information, please refer to **Network connections on page 74**.

Your computer's built-in network features make it easy for you to connect your computer to the internet using a cable or a wireless connection.

First though, in order to connect to the internet, you'll need to sign up for internet services from an ISP (Internet Service Provider) -- usually a phone or cable company -- that will have to go to your home or office to set up internet service. The ISP will install a small box, a router or modem, that will allow you to connect to the internet.

Connecting to a wireless network

Connecting to a wireless LAN

A wireless LAN (or WLAN) is a *wireless local area network*, which can link two or more computers without using wires. Once connected to WLAN, you can access the internet. You can also share files, other devices, and even your internet connection itself.



Warning

Using wireless devices while flying in aircraft may be prohibited. All wireless devices must be switched off before boarding an aircraft and during take-off, as they may be dangerous to the operation of the aircraft, disrupt communications, and even be illegal. You may turn on your computer's wireless devices only when informed that it is safe to do so by the cabin crew.

Your computer's wireless connection is turned on by default and Windows will detect and display a list of available networks during setup. Select your network and enter the password if required.

Acer notebook computers feature an *Airplane mode* hotkey that turns the network connection on or off. You can use the network

management options to turn your wireless network on/off or control what is shared over the network.

To connect to a wireless network, please follow the steps below.

1. Ensure you have a wireless router/access point and current internet connection through the ISP of your choice. Make a note of the wireless network's name and password (if necessary). If you are trying to connect to a public network (such as at a coffeeshop), make sure you have the wireless network's name.



Note

Please refer to your ISP or router documentation for details on connecting to the internet.

2. In the icon tray in the lower right-hand corner of the screen, select the *Notifications* icon to open the *Notifications* pane.

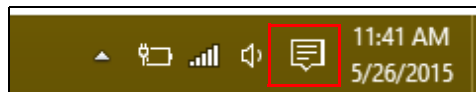

3. Select **All settings**.

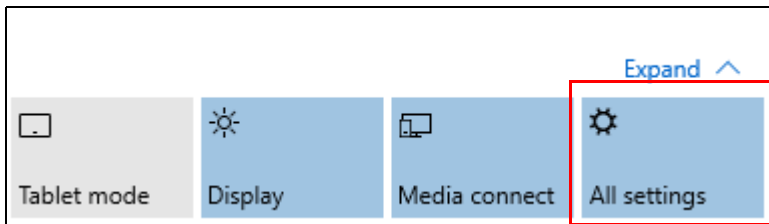

4. Select **Network & internet**.

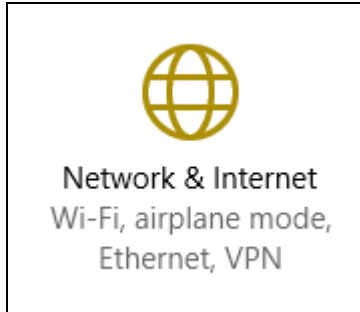

5. You will see a list of available wireless networks. Select the one you wish to use.

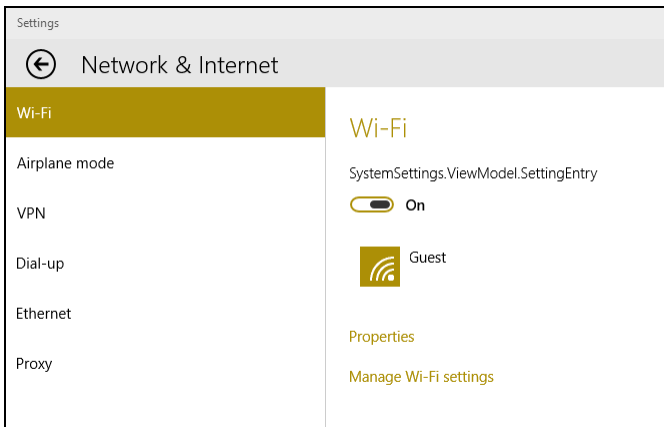

6. Once you select a wireless network, select **Connect**.

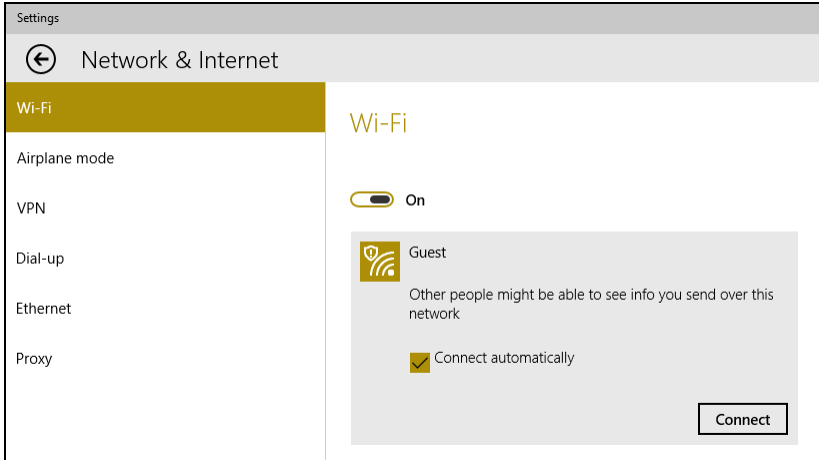

7. If required, enter the network's password.

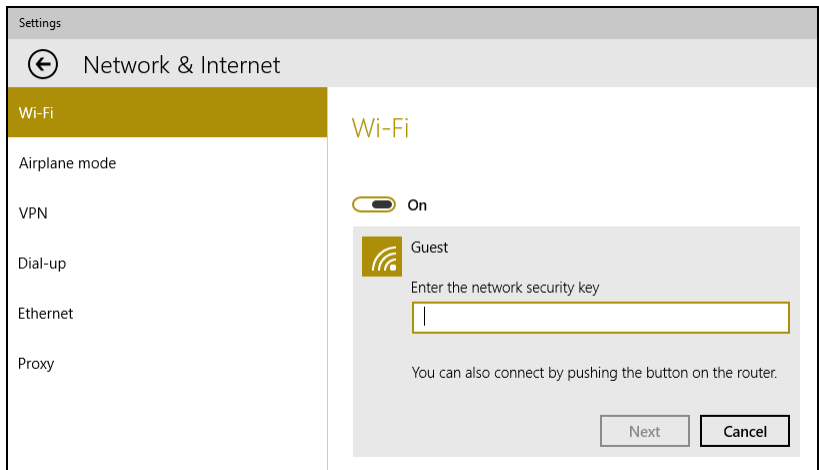

Connecting with a cable

Built-in network feature

Plug one end of a network cable into the network port on your computer, and the other end into a port on your router. (Refer to the image below.) Then, you'll be ready to get online.

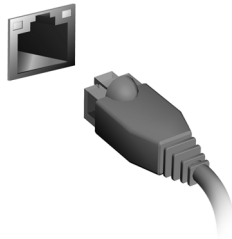

Connecting to a cellular network

If your computer has a SIM slot, you can connect to the internet using a cellular phone network. To do this, you must have a compatible SIM card and a data contract with your cellular provider. Contact your cellular provider for more information on connecting to the internet using a cellular network.

ACER BLUELIGHT SHIELD

Acer Bluelight Shield can be enabled to reduce the blue-light emissions from the screen to protect your eyes.

To configure Acer Bluelight Shield, *Search* for 'Acer Quick Access'. From here you can toggle Acer Bluelight Shield on or off, and you can choose from four different modes to fit your needs:

No.	Item	Description
1	Low Reduction	Reduces blue light emission from the LED backlit screen by 10% to 25% for basic protection.
2	Medium Reduction	Reduces blue light emission from the LED backlit screen by 26% to 45% to protect your eyes.
3	High Reduction	Reduces blue light emission from the LED backlit screen by 46% to 65% for maximum protection.
4	Long Hour Mode	Professionally tuned to reduce eye strain over an extended period of time.



Note

Specifications vary depending on model.

Keeping your computer and data safe...

In this section you will find:

- How to secure your computer
- Setting passwords
- What you need to prepare when you're traveling
- How to get the most out of your battery

ACER PROSHIELD

Overview

An all-in-one security solution, Acer ProShield provides an embedded security solution to address the following points of vulnerability:

- Securing the device against unauthorized access
- Protecting local storage
- Securing the network

Acer ProShield includes five modules that will secure your device from unauthorized access and intrusion.



Note

Your computer may not have all the modules mentioned below. Please refer to your computer's specifications to confirm which modules are supported.

- Credential Manager - Password, Fingerprint registration (if your PC has a fingerprint scanner), Online accounts configuration
- Pre-Boot Authentication - Boot sequence and device security
- Data Protection - Personal secure drive, file and folder encryption
- Data Removal - File shredder
- Information - About this software

Setting up Acer ProShield

The first time you run Acer ProShield, you will be led through a setup wizard that allows you to set up the parameters for Acer ProShield.

Click **Start** to begin. You will be required to set a password, and can choose to create a Personal Secure Drive.

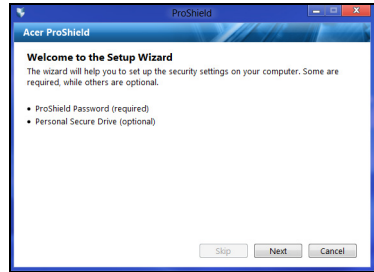
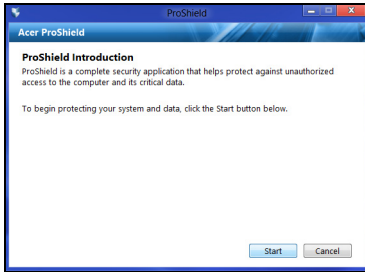

Note

Select a password that you will remember, but is difficult to guess. Do not use words that can be found in a dictionary. It is advisable to use a combination of letters and numbers.

Once you have set a password, you can click **Next** to proceed to setting up a Personal Secure Drive or click **Finish** to exit the wizard.

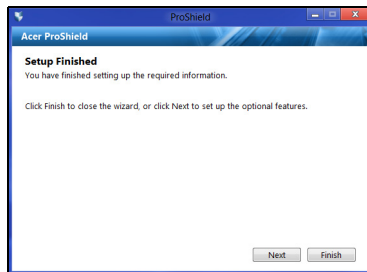

Personal Secure Drive

The Personal Secure Disk (PSD) is a secure section of your hard disk where you can save files. You can only get access to the PSD via password or fingerprint authentication.

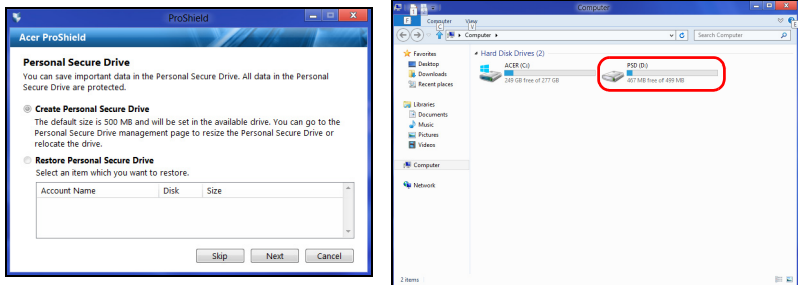

Once setup is finished, you can go to the ProShield Console to manage your computer or make changes to the settings.

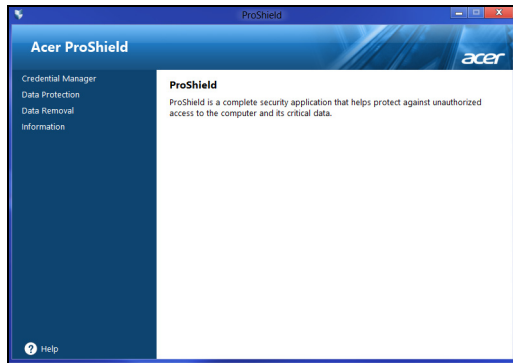

Use the menu in the left-hand pane to make changes.

Credential Manager

Here you can set and manage your credentials, including Pre-boot authentication.

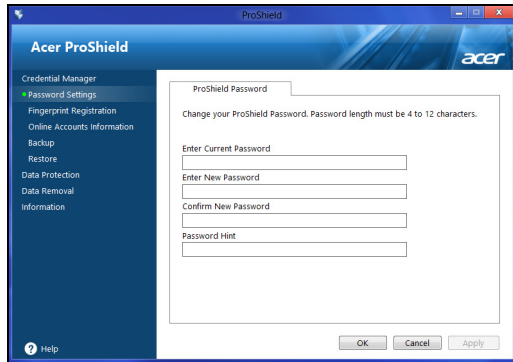

You can change your ProShield and Windows passwords, register fingerprints, manage online account information, and back up or restore credential information.

Fingerprint Registration*

* (only if your PC has a fingerprint scanner)

You can use a fingerprint scanner to secure your PC from unauthorized access. Register two or more fingerprints that can then be used to access your PC during start up, instead of your password.



Click **Registration Tutorial** for more information.

Data Protection

Here you can select files for encryption or decryption, and manage your Personal Secure Drive.

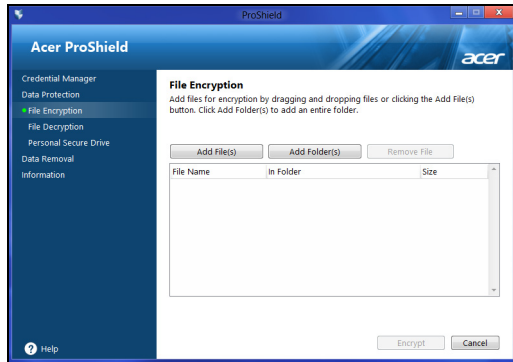

Data Removal

Here you can select files to be completely removed from the hard disk. The File Shredder overwrites the data to make recovering the data impossible.

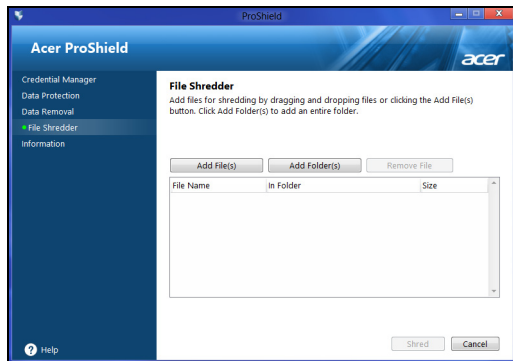

Warning

Make sure you select only the information you want to shred. Once you have shredded a file or folder, it is impossible to recover the data.

SECURING YOUR COMPUTER

Your computer is a valuable investment that you need to take care of. Learn how to protect and take care of your computer.

Security features include hardware and software locks — a security notch and passwords.

Using a computer security lock

The computer comes with a Kensington-compatible security slot for a security lock.

Wrap a computer security lock cable around an immovable object such as a table or handle of a locked drawer. Insert the lock into the notch and turn the key to secure the lock. Some keyless models are also available.

Using passwords

Passwords protect your computer from unauthorized access. Setting these passwords creates several different levels of protection for your computer and data:

- Supervisor Password prevents unauthorized entry into the BIOS utility. Once set, you must enter this password to gain access to the BIOS utility. **See Setting passwords on page 44.**
- User Password secures your computer against unauthorized use. Combine the use of this password with password checkpoints on boot-up and resume from Hibernation (if available) for maximum security.
- Password on Boot secures your computer against unauthorized use. Combine the use of this password with password checkpoints on boot-up and resume from Hibernation (if available) for maximum security.



Important

Do not forget your Supervisor Password! If you forget your password, please get in touch with your dealer or an authorized service center.

Entering passwords

When a password is set, a password prompt appears in the center of the display screen.

- When the Supervisor Password is set, a prompt appears when you enter the BIOS utility.
- Type the Supervisor Password and press **<Enter>** to access the BIOS utility. If you enter the password incorrectly, a warning message appears. Try again and press **<Enter>**.
- When the User Password is set and the password on boot parameter is enabled, a prompt appears at boot-up.
- Type the User Password and press **<Enter>** to use the computer. If you enter the password incorrectly, a warning message appears. Try again and press **<Enter>**.



Important

You have three chances to enter a password. If you fail to enter the password correctly after three tries, the system halts. Press and hold the power button for four seconds to shut down the computer. Then turn on the computer again, and try again.

BIOS UTILITY

The BIOS utility is a hardware configuration program built into your computer's BIOS.

Your computer is already properly configured and optimized, and you do not normally need to run this utility. However, if you encounter configuration problems, you may need to run it.

To activate the BIOS utility, press <F2> while the computer logo is being displayed.

Boot sequence

To set the boot sequence in the BIOS utility, activate the BIOS utility, then select **Boot** from the categories listed on the left of the screen.

Setting passwords

To set a password on boot, activate the BIOS utility, then select **Security** from the categories listed on the left of the screen.

Find **Set Supervisor Password** and enter a password to enable this feature. Once you have entered a password for this feature, you may then enable/disable **Password on Boot**.

Remember to select <F10> to properly save and exit the BIOS utility when you are done making changes.

POWER MANAGEMENT

This computer has a built-in power management unit that monitors system activity. System activity refers to any activity involving one or more of the following devices: keyboard, mouse, hard disk, peripherals connected to the computer, and video memory. If no activity is detected for a period of time, the computer stops some or all of these devices in order to conserve energy.

Saving power

Disable Fast startup

Your computer uses Fast startup to start quickly, but also uses a small amount of power to check for signals to start. These checks will slowly drain your computer's battery.

If you prefer to reduce your computer's power requirements and environmental impact, turn off Fast startup:



Note

If Fast startup is off, your computer will take longer to start from Sleep. Your computer will also not start if it receives an instruction to start over a network (Wake on LAN).

1. Open the desktop.
2. Click **Power Options** in the Notification area.
3. Select **More Power Options**.
4. Select **Choose what the power buttons do**.

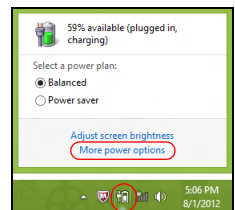

5. Select **Change settings that are currently unavailable**.

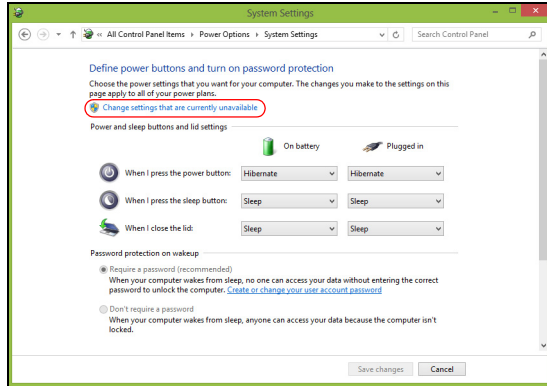

6. Scroll down and disable **Turn on fast startup**.

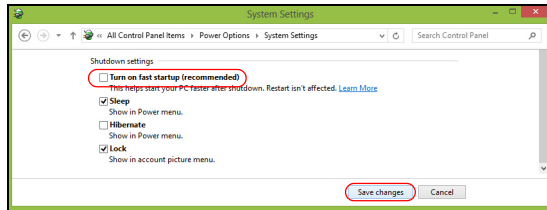

7. Select **Save changes**.

BATTERY PACK

The computer uses an embedded Lithium battery that gives you long use between charges.

Battery characteristics

The battery is recharged whenever you connect the computer to the AC adapter. Your computer supports charge-in-use, enabling you to recharge the battery while you continue to operate the computer. However, recharging with the computer turned off significantly reduces charge time.

The battery will come in handy when you travel or during a power failure.

Charging the battery

Plug the AC adapter into the computer, and connect to a mains power outlet.



Note

You are advised to charge the battery before retiring for the day. Charging the battery overnight before traveling enables you to start the next day with a fully charged battery.

Conditioning a new battery pack

Before you use a battery pack for the first time, there is a conditioning process that you should follow:

1. Connect the AC adapter and fully charge the battery.
2. Turn on the computer and complete setting up the operating system.
3. Disconnect the AC adapter.
4. Operate the computer using battery power.
5. Reconnect the AC adapter and fully charge the battery again.

Follow these steps again until the battery has been charged and discharged three times.

Use this conditioning process for all new batteries, or if a battery hasn't been used for a long time.



Warning

Do not expose battery packs to temperatures below 0° C (32° F) or above 45° C (113° F). Extreme temperatures may adversely affect the battery pack.

The battery conditioning process ensures your battery accepts the maximum possible charge. Failure to follow this procedure will prevent you from obtaining the maximum battery charge, and will also shorten the effective lifespan of the battery.

In addition, the useful lifespan of the battery is adversely affected by the following usage patterns:

- Using the computer on constant AC power.
- Not discharging and recharging the battery to its extremes, as described above.
- Frequent use; the more you use the battery, the faster it will reach the end of its effective life. An embedded battery has a life span of more than 1,000 charge/discharge cycles.

Optimizing battery life

Optimizing battery life helps you get the most out of battery operation, prolonging the charge/recharge cycle and improving recharging efficiency. You are advised to follow the suggestions set out below:

- Use AC power whenever possible, reserving battery for mobile use.
- Remove accessories that are not being used (e.g. a USB disk drive), as they can continue to draw power.
- Store your PC in a cool, dry place. The recommended temperature is 10° C (50° F) to 30° C (86° F). Higher temperatures cause the battery to self-discharge faster.
- Excessive recharging decreases the battery life.
- Look after your AC adapter and battery.

Checking the battery level

The power meter indicates the current battery level. Rest the cursor over the battery/power icon on the taskbar to see the battery's present charge level.

Battery-low warning

When using battery power pay attention to the power meter.



Important

Connect the AC adapter as soon as possible after the battery-low warning appears. Data may be lost if the battery is allowed to become fully depleted and the computer shuts down.

When the battery-low warning appears, the recommended course of action depends on your situation:

Situation	Recommended Action
The AC adapter and a power outlet are available.	<ol style="list-style-type: none"> 1. Plug the AC adapter into the computer, and then connect to the main power supply. 2. Save all necessary files. 3. Resume work. <p>Turn off the computer if you want to recharge the battery rapidly.</p>
The AC adapter or a power outlet is unavailable.	<ol style="list-style-type: none"> 1. Save all necessary files. 2. Close all applications. 3. Turn off the computer.

TRAVELING WITH YOUR COMPUTER

This section gives you tips and hints to consider when moving around or traveling with your computer.

Disconnecting from the desktop

Follow these steps to disconnect your computer from external accessories:

1. Save any open files.
2. Remove discs from optical drive.
3. Shut down the computer or put it into Sleep or Hibernate mode.
4. Close the display cover.
5. Disconnect the cord from the AC adapter.
6. Disconnect the keyboard, pointing device, printer, external monitor and other external devices.
7. Disconnect the Kensington lock if you are using one to secure the computer.

Moving around

When you are just moving within short distances, for example, from your office desk to a meeting room.

Preparing the computer

Before moving the computer, close and latch the display cover to place it in Sleep mode. You can now safely take the computer anywhere you go within the building. To wake the computer from Sleep mode, open the display and, if necessary, press and release the power button.

If you are taking the computer to a client's office or a different building, you may choose to shut down the computer:

Press the *Windows key* + <C>, click **Settings** > **Power** then click **Shut Down**

Or:

You can put the computer in Sleep mode by pressing the Sleep hotkey or by closing the display.

When you are ready to use the computer again, open the display and, if necessary, press and release the power button.



Note

The computer may enter Hibernation or Deep Sleep mode after being in Sleep mode for a period of time.

What to bring to meetings

If your meeting is relatively short, you probably do not need to bring anything with you other than your computer. If your meeting will be longer, or if your battery is not fully charged, you may want to bring the AC adapter with you to plug in your computer in the meeting room.

If the meeting room does not have an electrical outlet, reduce the drain on the battery by putting the computer in Sleep mode. Press the Sleep hotkey or close the display cover whenever you are not actively using the computer.

Taking the computer home

When you are moving from your office to your home or vice versa.

Preparing the computer

After disconnecting the computer from your desktop, follow these steps to prepare the computer for the trip home:

- Check that you have removed all media and compact discs from the drive(s). Failure to remove the media can damage the drive head.
- Pack the computer in a protective case that can prevent the computer from sliding around and cushion it if it should fall.



Warning

Avoid packing items next to the top cover of the computer. Pressure against the top cover can damage the screen.

What to take with you

Unless you have some items at home, take the following items with you:

- AC adapter and power cord.
- The printed *Setup Guide*.

Special considerations

Follow these guidelines to protect your computer while traveling to and from work:

- Minimize the effects of temperature changes by keeping the computer with you.
- If you need to stop for an extended period of time and cannot carry the computer with you, leave the computer in the trunk of the car to avoid exposing the computer to excessive heat.
- Changes in temperature and humidity can cause condensation. Allow the computer to return to room temperature, and inspect the screen for condensation before turning on the computer. If the temperature change is greater than 10° C (18° F), allow the computer to come to room temperature slowly. If possible, leave the computer for 30 minutes in an environment with a temperature between outside and room temperature.

Setting up a home office

If you frequently work on your computer at home, you may want to purchase a second AC adapter for use at home. With a second AC adapter, you can avoid carrying the extra weight to and from home.

If you use your computer at home for significant periods of time, you might also want to add an external keyboard, monitor or mouse.

Traveling with the computer



Important

Check with your airline for any special requirements for travelling with Lithium batteries.

When you are moving within a larger distance, for instance, from your office building to a client's office building or traveling locally.

Preparing the computer

Prepare the computer as if you were taking it home. Make sure that the battery in the computer is charged. Airport security may require you to turn on your computer when carrying it into the gate area.

What to take with you

Take the following items with you:

- AC adapter
- Additional printer driver files if you plan to use another printer

Special considerations

In addition to the guidelines for taking the computer home, follow these guidelines to protect your computer while traveling:

- Always take the computer as carry-on luggage.
- If possible, have the computer inspected by hand. Airport security X-ray machines are safe, but do not put the computer through a metal detector.

Traveling internationally



Important

Check with your airline for any special requirements for travelling with Lithium batteries.

When you are moving from country to country.

Preparing the computer

Prepare the computer as you would normally prepare it for traveling.

What to bring with you

Bring the following items with you:

- AC adapter.
- Power cords that are appropriate for your destination(s).
- Additional printer driver files if you plan to use another printer.
- Proof of purchase, in case you need to show it to customs officials.
- International Travelers Warranty passport.

Special considerations

Follow the same special considerations as when traveling with the computer.

In addition, these tips are useful when traveling internationally:

- When traveling in another country, check that the local AC voltage and the AC adapter power cord specifications are compatible. If not, purchase a power cord that is compatible with the local AC voltage. Do not use converter kits sold for appliances to power the computer.
- If you are using the modem, check if the modem and connector are compatible with the telecommunications system of the country you are traveling in.

Ports and connectors...

In this section you will find:

- Information on the ports and connectors fitted to your computer

MEMORY CARD READER

Connectivity options

Your computer has a card reader and other ports/jacks that allow you to connect peripheral devices to your computer. For instructions on how to connect different external devices to the computer, read the following section.

Memory card reader

Memory cards are used in a wide selection of digital cameras, PDAs, MP3 players and mobile phones.

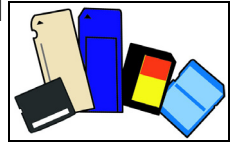

Inserting a memory card

1. Align the card so that the connector points towards the port, with the connectors facing down.
2. Carefully slide the card into the port. If you find you need to use any force to insert the card, try reorientating the card slightly.
3. Push the card until it clicks into place. A few millimetres of the card will extend from beyond the slot.

If the card contains some files, the *Windows Auto Play* window may appear (this depends on the contents of the card) and ask you if you wish to use a program to access the contents of the card. Select an option here if it is appropriate, otherwise select **Cancel**. If the card contains no files, or unknown files, a window will open showing the contents of the card.

SD, SDHC and SDXC cards

Different types of SD cards cover different capacities, while using the same overall design. SD cards contain up to 4 GB; SDHC cards contain up to 32 GB; and SDXC cards can contain up to 2048 GB

(2 TB). Your computer provides an SDHC or SDXC compatible card reader.



Note

SDXC memory cards can only be used in an SDXC-compatible reader; SD and SDHC cards can be used in either type.

Removing a card from a memory card reader

1. Click on **Show hidden icons** arrow in the *Notification Area* (next to the clock).
2. Click on the **Safely Remove Hardware** icon.
3. Click on **Eject SD Card** (or the name of the device).
4. Wait until a *Safe to Remove Hardware* message is displayed.
5. Remove the card.

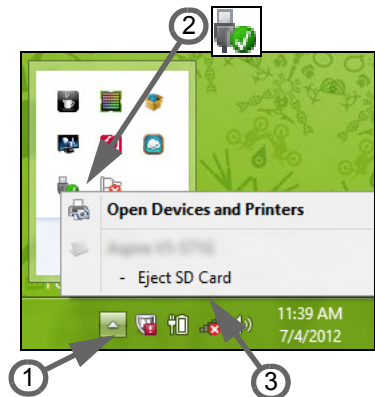

VIDEO AND AUDIO CONNECTORS

Connect to a monitor with a VGA or DVI port (the type of connection supported depends on your computer's configuration). The appropriate cable is usually included with the monitor.

Follow these steps to connect an monitor to your computer:

1. Check that the computer is powered off and the monitor power switch is turned off.
2. Attach the video cable to the monitor port on the computer. Secure the cable connection with the screws provided.
3. Connect the monitor power cable and plug it into a properly grounded wall outlet.
4. Follow any setup instructions in the monitor's user's guide.
5. Turn on power to the monitor, then the computer.
6. Make sure that the current resolution and refresh rate do not exceed the specifications of the monitor. If necessary change the display settings used by the computer.



Note

*To access the display controls, press the Windows key (⊞) + W, type "Display" and then click on **Display**.*

Headphones and microphone

These ports allow you to connect audio devices. Use the headphone port to plug in stereo headphones or powered speakers. Plugging an audio device to the headphone port disables the built-in speakers. Use the microphone port to connect an external microphone for mono recording; plugging in an external microphone disables the built-in microphone.



Note

Some computers have a single "combo" port that allows you to use single-pin headsets with a built-in microphone. These headsets are most commonly used with smartphones.

UNIVERSAL SERIAL BUS (USB)

The USB port is a high-speed port which allows you to connect USB peripherals, such as a mouse, an external keyboard, additional storage (external hard disks), or any other compatible device.

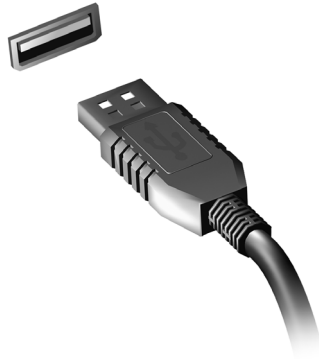

Note

Two USB standards are currently available on Acer computers: USB 2.0 (High-speed USB) and USB 3.0 (SuperSpeed USB). USB 2.0 ports on Acer computers have a black tongue in the port, while USB 3.0 ports have a blue tongue. For best performance, USB 3.0 devices should always be plugged into USB 3.0 ports. Consult your device's documentation to see which standard it supports.

You can also charge devices such as tablets, smartphones, or other devices through a USB port. Some USB 3.0 ports support charging devices when the computer is in Hibernate or turned off. Additionally, you can use a USB hub to connect multiple devices to a single USB port.



Important

When removing a USB storage device, you should right-click on the USB icon in the Windows task bar and select "Eject <device>" to tell the operating system to stop using the device before removing it. Failure to do this may result in data loss or damage to your peripheral.

HDMI

HDMI (High-Definition Multimedia Interface) is a high-quality, digital audio/video interface. HDMI allows you to connect any compatible digital audio/video source, such as your computer, a set-top box, DVD player, and audio/video receiver to any compatible digital audio and/or video monitor, such as a digital television (DTV) with a single cable.

The single cable keeps everything neat and tidy while ensuring easy connection and the best audio and visual quality.

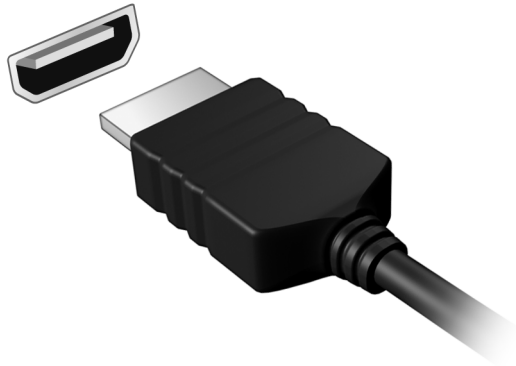

Got a question?

In this section you will find:

- Frequently asked questions
- Tips for using Windows 10
- Troubleshooting information
- How to protect yourself while online
- Where to find Acer service center contact information

FREQUENTLY ASKED QUESTIONS

The following is a list of possible situations that may arise during the use of your computer. Easy solutions are provided for each one.

I turned on the power, but the computer does not start or boot up.

Look at the power indicator:

- If it is not lit, no power is being supplied to the computer. Check the following:
 - If you are using on the battery, it may be low and unable to power the computer. Connect the AC adapter to recharge the battery pack. You may need to wait a few minutes before trying to turn your computer on again.
 - Make sure that the AC adapter is properly plugged into the computer and to the power outlet.
- If it is lit, check the following:
 - Is a disc in the optical drive? Remove it and press **<Ctrl> + <Alt> + ** to restart the system.
 - Do you have a USB storage device (USB drive or smartphone) plugged into your computer? Unplug it and press **<Ctrl> + <Alt> + ** to restart the system.

Nothing appears on the screen.

The computer's power management system automatically blanks the screen to save power. Press any key to turn the display back on.

If pressing a key does not turn the display back on, three things might be the cause:

- The brightness level might be too low. Press **<Fn> + <▷>** (increase) to adjust the brightness level.
- The display device might be set to an external monitor. Press the display toggle hotkey to toggle the display back to the computer.
- If the power LED is flashing, the computer may be in Sleep or Hibernate mode. Press and release the power button to resume.

No audio is heard from the computer.

Check the following:

- The volume may be muted. Look at the volume control (speaker) icon in the taskbar. If it is crossed-out, click the icon and deselect the **Mute all** option.
- The volume level may be too low. Check the volume from the volume control (speaker) icon in the taskbar. You can also use the volume control hotkeys to adjust the volume.
- If headphones, earphones or external speakers are connected to the headphone jack on the computer, the internal speakers automatically turn off.

I want to eject the optical drive tray without turning on the power.

There is a mechanical eject hole on the optical drive. Insert the tip of a pen or straightened-out paperclip into the hole and push to eject the tray.

The keyboard does not respond.

Try attaching an external keyboard to a USB port on the computer. If it works, contact your dealer or an authorized service center as the internal keyboard cable may be loose.

The printer does not work.

- Make sure that the printer is connected to a power outlet and that it is turned on.
- Make sure that the printer cable is connected securely to a USB port and the corresponding port on the printer.

I want to restore my computer to its original settings.



Note

If your system is the multilingual version, the operating system and language you choose when you first turn on the system will be the only option for future recovery operations.

This recovery process helps you restore the C: drive with the original software content that is installed when you purchased your computer.



Warning

Your C: drive will be reformatted and all data will be erased. It is important to back up all data files before using this option.

Before performing a restore operation, please check the BIOS settings.

1. Check to see if **Acer disk-to-disk recovery** is enabled or not.
2. Make sure the **D2D Recovery** setting in **Main** is **Enabled**.
3. Exit the BIOS utility and save changes. The system will reboot.



Note

To access the BIOS utility, press <F2> when you see the Acer logo during boot up.

For more information, see **Restoring your computer on page 24**.

Requesting service

International Travelers Warranty (ITW)

Your computer is backed by an International Travelers Warranty (ITW) that gives you security and peace of mind when traveling. An ITW passport came with your computer and contains all you need to know about the ITW program. A list of available, authorized service centers is in this handy booklet. Read this passport thoroughly.

Always have your ITW passport on hand, especially when you travel, to receive the benefits from our support centers. Attach your proof-of-purchase to the ITW passport.

If the country you are traveling in does not have an Acer-authorized ITW service site, you can still get in contact with our offices worldwide. Please visit **www.acer.com**.

Before you call

Please have the following information available when you call Acer for online service, and please be at your computer when you call. With your support, we can reduce the amount of time a call takes and help solve your problems efficiently. If there are error messages or beeps reported by your computer, write them down as they appear on the screen (or the number and sequence in the case of beeps).

You are required to provide the following information:

Name:	Machine and model type:
Address:	Serial number:
Telephone number:	Date of purchase:

Tips and hints for using Windows 10

We know this is a new operating system that will take some getting used to, so we've created a few pointers to help you get started.

How do I get to *Start*?

Press the Windows key or select the *Windows Start button* on the lower left-hand corner of the screen.

Where's the Start button?

The Start button will appear in the desktop taskbar. Selecting it will open *Start* where you can launch apps.

How do I see all of my apps?

Press the Windows key or select the *Windows Start button* and select **All apps** to show a list of installed apps on the computer.

How do I turn off my computer?

Press the Windows key or select the *Windows Start button* and select the power icon > **Shut down**. You can also turn off the computer by right-clicking the *Windows Start button* > **Shut down or sign out** > **Shut down**.

Can I turn off notifications?

You can turn off notifications so that you can leave your computer running, but not be disturbed by notifications.

Press the Windows key or select the *Windows Start button* and select **Settings** > **System** > **Notifications & actions**. From here you can enable/disable notifications for all of your apps or choose which apps to enable/disable.

How do I unlock my computer?

Press the space bar and select a user account icon to unlock the computer. If your account has a password set, you will need to enter the password to continue.

Can I personalize the Lock screen?

You can personalize the lock screen with a different image, to run a slideshow of images, or to show you quick status and notifications to suit your personal needs.

To change the background, press the Windows key or select the *Windows Start button* and select **Settings > Personalization**. From here you can:

- Select a background image for the lock screen
- Turn the *Slide show* on or off
- Select lock screen apps.

How do I set up the lock screen slideshow?

1. Press the Windows key or select the *Windows Start button* and select **Settings > Personalization**.
2. Under Background, select *Slideshow*.
3. Select **Add a folder** and open the folder you wish to use (your *Pictures* folder will open by default). Select **Choose this folder** to add the folder to the lock screen slideshow.
4. Select a folder and select **Remove** to remove the folder from the lock screen slideshow.
5. Change the other settings to suit your needs.

How do I move tiles?

Select a tile and drag it to the place on *Start* that you want it to appear. Other tiles will be moved to accommodate the tile in its new location.

Can I arrange tiles in groups?

Yes, you can. Select an existing tile and drag the tile to arrange *Start* to your liking. Right-click on an app and select **Pin to Start** to create a new group on *Start*. From here, you can drag the tile to an existing group on *Start*. You can give the group(s) a name and arrange the tiles within the groups to suit your needs.

Can I make tiles bigger or smaller?

Yes, you can. Right-click on a tile and select **Resize**. Select a size from the menu that appears.

Can I change the screen resolution?

Yes, you can. Move your cursor to the lower left-hand corner of the screen and type 'Control Panel' in the text box to display the results; select **Control Panel > Adjust screen resolution**. Alternatively, you can also right-click anywhere on the desktop and select **Screen resolution**.

How do I set the alarm?

Your computer can act as an alarm clock. Search 'Alarms' and then select **Alarms**.

1. Select a name for the alarm.
2. Set the time by choosing the hour and minute.
3. Select AM or PM.
4. Choose which days the alarm should go off.
5. Select the sound notification.
6. Select the snooze time.
7. Save the alarm by selecting the Save icon in the bottom right-hand corner.



Note

The alarm will only sound if your computer is awake at the set time.

Where are my apps?

Move your cursor to the lower left-hand corner of the screen and select **Search**, start typing the name of the app you would like to open.

How do I make an app appear on Start?

If you're in *All apps* and you want to make an app appear on *Start*, right-click an app and select **Pin to Start**.

How do I remove a tile from Start?

Right-click a tile to select it and select **Unpin from Start** to remove the tile from *Start*.

How do I make an app appear on my taskbar?

If you're in *All apps* and you want to make an app appear on the taskbar, right-click an app or tile and select **Pin to taskbar**.

How do I install apps?

You can download Windows Store apps from *Store*. You will need to have a Microsoft ID to purchase and download apps from *Store*.

I can't find apps like Notepad and Paint! Where are they?

Move your cursor to the lower left-hand corner of the screen and select **Search**. Type the name of the app you would like to open. Alternatively, open *All apps* and scroll to 'Windows Accessories' to see the list of legacy programs.

What is a Microsoft ID (account)?

A Microsoft account is an email address and password that you use to sign in to Windows. You can use any email address, but it is best if you choose the one you already use to communicate with friends and sign in to your favorite websites. When you sign in to your PC with a Microsoft account, you'll connect your PC to the people, files, and devices you care about.

Do I need one?

You do not need a Microsoft ID to use Windows 10, but it makes life easier because you can sync data across different machines you sign in to using a Microsoft ID.

How do I get one?

If you've already installed Windows 10 and didn't sign in with a Microsoft account or you don't have a Microsoft account and want to get one, press the Windows key or select the *Windows Start button* > **Settings** > **Accounts** > **Sign in with a Microsoft account**, and follow the onscreen instructions.

How do I check for Windows updates?

Press the Windows key or select the *Windows Start button* > **Settings** > **Update & recovery** > **Windows Update**. Select **Advanced options** to configure the settings.

Where can I get more information?

For more information please visit the following pages:

- Windows 10 information: go.acer.com/windows-tutorial
- Support FAQs: support.acer.com

Troubleshooting

This chapter shows you how to deal with common system problems. Read it before calling a technician if a problem occurs. Solutions to more serious problems require opening up the computer. Do not attempt to open the computer yourself; contact your dealer or authorized service center for assistance.

Troubleshooting tips

This computer incorporates an advanced design that delivers onscreen error message reports to help you solve problems.

If the system reports an error message or an error symptom occurs, see "Error messages" below. If the problem cannot be resolved, contact your dealer.

Error messages

If you receive an error message, note the message and take the corrective action. The following table lists the error messages in alphabetical order together with the recommended course of action.

Error messages	Corrective action
CMOS battery bad	Contact your dealer or an authorized service center.
CMOS checksum error	Contact your dealer or an authorized service center.
Disk boot failure	Insert a system (bootable) disk, then press <Enter> to reboot.
Equipment configuration error	Press <F2> (during POST) to enter the BIOS utility, then press Exit in the BIOS utility to reboot.
Hard disk 0 error	Contact your dealer or an authorized service center.
Hard disk 0 extended type error	Contact your dealer or an authorized service center.
I/O parity error	Contact your dealer or an authorized service center.

Error messages	Corrective action
Keyboard error or no keyboard connected	Contact your dealer or an authorized service center.
Keyboard interface error	Contact your dealer or an authorized service center.
Memory size mismatch	Press <F2> (during POST) to enter the BIOS utility, then press Exit in the BIOS utility to reboot.

If you still encounter problems after going through the corrective measures, please contact your dealer or an authorized service center for assistance.

INTERNET AND ONLINE SECURITY

First steps on the net

Protecting your computer

It is vital to protect your computer from viruses and attacks over the internet (see **Security on page 76**). A comprehensive internet security program is offered when you first start your computer. You should activate this protection as soon as possible, certainly before you connect to the internet.

Choose an Internet Service Provider



Using the internet has become a natural part of daily computing. Just a few simple steps can connect you to a vast collection of knowledge and communication tools. To accomplish these steps you should first select an *Internet Service Provider* (ISP), which supplies the connection between your computer and the internet. You should research the ISPs available in your region, not forgetting to talk to friends and family about their experiences or to check reviews and consumer reports. The ISP you select will provide instructions on how to connect to the internet (you may need additional software or a special 'box' that connects to your phone line).

Connection types

Depending on your computer model, your location and your communication needs, you have several ways to connect to the internet.

Dial-up

Some computers include a telephone dial-up ('modem') connector. This allows you to connect to the internet using your telephone line. With a dial-up connection, you cannot use the modem and the telephone simultaneously on a single phone line. This type of connection is recommended only if you have limited use of the

internet as the connection speed is low and connection time is typically charged per hour.

DSL (e.g. ADSL)

DSL (Digital Subscriber Line) is an 'always-on' connection that runs over the phone line. As DSL and phone do not use the same frequencies, you can use your telephone at the same time you are connected to the internet (this requires a 'micro-filter' on each telephone socket to avoid interference). To be eligible for DSL, you must be located near an DSL-equipped phone exchange (service is sometimes unavailable in rural areas). Connection speeds vary depending on your location, but DSL generally provides very fast and reliable internet connection. As the connection is always-on, it is generally charged at fixed monthly rates.



Note

A DSL connection requires an appropriate modem. A modem is usually provided by the ISP when you register. Many of these modems include an 'router' that provides network and Wi-Fi access.

Cable

A cable connection provides fast and always-on internet service via a cable television line. This service is generally available in large cities. You can use your telephone and watch cable TV at the same time you are connected to the internet.

Cellular

A cellular connection allows you to use cellular networks (such as those used by a mobile phone) to connect to the internet while away from home. The socket for a SIM card may be built in to your computer, or may require an external device, such as a USB modem or even an appropriately equipped mobile phone.



Note

*If your computer includes a SIM card slot, you require a compatible SIM card and a contract with a cellular provider.
Before using the cellular features, check with your service provider to see if any additional charges will be incurred, especially roaming charges.*

Network connections

A LAN (Local Area Network) is a group of computers (for example, within an office building or home) that share a common communications line and resources. When you set up a network, you can share files, peripheral devices (such as a printer) and an internet connection. You can set up a LAN using wired technologies (such as Ethernet) or wireless technologies (such as Wi-Fi or Bluetooth).

Wireless networks

A wireless LAN or WLAN is a wireless local area network, which may link two or more computers without using wires. Setting up a wireless network is easy and allows you to share files, peripheral devices and an internet connection.

What are benefits of a wireless network?

Mobility

Wireless LAN systems allow you and other users of your home network to share access to files and devices connected to the network, for example a printer or scanner.

Also you can share an internet connection with other computers in your home.

Installation speed and simplicity

Installing a wireless LAN system can be fast and easy and eliminates the need to pull cables through walls and ceilings.

Components of a wireless LAN

To set up your Wireless network at home you need to have the following:

Access point (router)

Access points (routers) are two-way transceivers that broadcast data into the surrounding environment. Access points act as a mediator between wired and wireless network. Most routers have a built-in DSL modem that will allow you access to a high speed DSL internet connection. The ISP (Internet Service Provider) you have chosen normally supplies a modem/router with the subscription to their

services. Read carefully the documentation supplied with your Access point/router for detailed setup instructions.

Network cable (RJ45)

A network cable (also called RJ45 cable) is used to connect the host computer to the access point (see illustration below); this type of cable may also be used to connect peripheral devices to the access point.

Wireless adapter

An internal wireless adapter is normally already installed in your computer. A button or controls in Windows allow you to activate or deactivate the adapter. 

Diagram of a working network

1. Access point/router
2. Desktop computer
3. Modem
4. Printer
5. Portable computer
6. PDA/Smartphone
7. Network cables (RJ45)

Turning on/off a wireless network connection

Most computers feature a 'Wi-Fi' button that turns the network connection on or off. If your computer has wireless access, but does not feature a *Communication* button, you may turn your wireless network on or off, or control what is shared over the network with the network management options. Search 'HomeGroup' and then click on **HomeGroup**.



Warning

Using wireless devices while flying in aircraft may be prohibited. Switch off all devices before boarding an aircraft; they may be dangerous to the operation of the aircraft, disrupt communications, and even be illegal. After take off, ask the cabin crew if you may enable Wi-Fi.

Surf the Net!

To surf the internet, you need a program called an internet browser. *Internet Explorer* provides an easy and secure web browsing experience. As soon as you have your internet access installed and you are connected, from Start, click the Internet Explorer tile or the icon located on the desktop and take your internet experience to a new level!



Acer website

To get you started why not visit our website, **www.acer.com**.

Acer is dedicated to provide you with on-going personalized support. Check out our *Support* section to get help tailored to your needs.

www.acer.com is your portal to a world of online activities and services: visit us regularly for the latest information and downloads!

Security

You are probably eager to explore everything the internet has to offer. In order for you to be safe online, Acer has pre-installed McAfee Internet Security Suite on your computer.

McAfee Internet Security Suite runs quietly in the background to block today's complex threats and protect your identity when you shop, bank, or browse online.

McAfee Internet Security Suite blocks online identity theft, detects and eliminates spyware, removes viruses and internet worms, protects against hackers.

Definitions

What is a virus?

Malicious software, typically called 'viruses', are programs designed to infect and damage computers. Most viruses are transmitted over the internet, emails or malicious web sites. A typical virus will replicate and pass itself undetected to multiple computers. Other forms of nuisance, such as Trojan horses, worms or spam can infect your

computer in various ways, using up resources or clogging up a network.



Note

Acer guarantees that your computer was 100% virus free at the time of purchase and does not cover damages due to viruses.

What is spyware?

Spyware refers to generally unwanted programs that are downloaded onto your computer while connected to the internet, often without you knowing it. Once it has infected your computer, it can snoop on your browsing activity, collect personal information, cause pop-up ads to appear, or even change the configuration of your computer. Spyware consumes resources on your computer; it can slow down your internet connection or entire computer system, and even cause crashes.

Spyware is sometimes used by unscrupulous companies to monitor and track the sites you visit on the internet so as to determine your web-surfing habits and display targeted pop-up ads on your screen. However, some kinds of spyware go beyond simple tracking and actually monitor keystrokes and capture passwords, posing a serious security risk.

What is malware?

Malicious software, also known as *malware*, is software designed to deliberately harm your computer. For example, viruses, worms, and Trojan horses are malicious software. To help protect your computer against malware, make sure it is using up-to-date antivirus and anti-malware software.

What is a personal firewall?

A personal firewall is a software program designed to prevent unauthorized access to or from a private network. It acts as a shield to protect your internet connection from unwanted connections, some of which may attempt to take control of your computer to install or re-distribute viruses or malicious programs. Each connection to your computer is monitored - programs that attempt to receive information without your permission are detected and the firewall will display an alert. You can then decide if you will allow the connection, if the connection is to a program you are currently using then normally you

would allow it (i.e. a game connecting to a multi-player server or an encyclopaedia making a content update).

How to protect your computer

Cybercrime prevention can be straight-forward - when armed with a little technical advice and common sense, many attacks can be avoided. In general, online criminals are trying to make their money as quickly and easily as possible. The more difficult you make their job, the more likely they are to leave you alone and move on to an easier target. The tips below provide basic information on how you can prevent online fraud.

Keep your computer current with the latest patches and updates

One of the best ways to keep attackers away from your computer is to apply patches and other software fixes when they become available. By regularly updating your computer, you block attackers from being able to take advantage of software flaws (vulnerabilities) that they could otherwise use to break into your system.

While keeping your computer up-to-date will not protect you from all attacks, it makes it much more difficult for hackers to gain access to your system, blocks many basic and automated attacks completely, and might be enough to discourage less-determined attackers, so they will give up and look for a more vulnerable computer elsewhere.

More recent versions of Microsoft Windows and other popular software can be configured to download and apply updates automatically so that you do not have to remember to check for the latest software. Taking advantage of auto-update features in your software is a great start toward keeping yourself safe online.

Protect your computer with security software

Several types of security software are necessary for basic online security. Security software essentials include firewall and antivirus programs. A firewall is usually your computer's first line of defense-it controls who and what can communicate with your computer online. You could think of a firewall as a sort of "policeman" that watches all the data attempting to flow in and out of your computer on the internet, allowing communications that it knows are safe and blocking "bad" traffic such as attacks from ever reaching your computer.

The next line of defense many times is your antivirus software, which monitors all online activities such as email messages and web browsing and protects an individual from viruses, worms, Trojan horse and other types of malicious programs. Your antivirus and antispyware software should be configured to update itself, and it should do so every time you connect to the internet.

Integrated security suites such as McAfee Internet Security Suite, which combine firewall, antivirus, antispyware with other features such as antispam and parental controls, have become popular as they offer all the security software needed for online protection in a single package. Many people find using a comprehensive security suite an attractive alternative to installing, configuring and updating several different types of security software.

A complete version of McAfee Internet Security Suite is pre-installed on your Acer system. It includes a free trial subscription to protection updates. Make sure you Activate it!

Choose strong passwords and keep them safe

Passwords are a fact of life on the internet today; we use them for everything from ordering flowers and online banking to logging into our favorite airline web site to see how many miles we have accumulated. The following tips can help make your online experiences secure:

- Selecting a password that cannot be easily guessed is the first step toward keeping passwords secure and out of the wrong hands. Strong passwords have eight characters or more and use a combination of letters, numbers and symbols (e.g., # \$ % ! ?). Avoid using any of the following as your password: your login name, anything based on your personal information such as your last name, and words that can be found in the dictionary, especially "password." Try to select especially strong, unique passwords for protecting activities like online banking.
- Keep your passwords in a safe place and try not to use the same password for every service you use online.
- Change passwords on a regular basis, at least every 90 days. This can limit the damage caused by someone who has already gained access to your account. If you notice something suspicious with one

of your online accounts, one of the first steps you can take is to change your password.

Protect your personal information

Exercise caution when sharing personal information such as your name, home address, phone number, and email address online. To take advantage of many online services, you will inevitably have to provide personal information in order to handle billing and shipping of purchased goods. Since not divulging any personal information is rarely possible, the following list contains some advice for how to share personal information safely online:

- **Keep an eye out for phony email messages.** Things that indicate a message may be fraudulent are misspellings, poor grammar, odd phrasing, web site addresses with strange extensions, web site addresses that are entirely numbers where there are normally words, and anything else out of the ordinary. Additionally, phishing messages will often tell you that you have to act quickly to keep your account open, update your security, or urge you to provide information immediately or else something bad will happen. Don't take the bait.
- **Do not click on a link in an email,** unless you specifically asked for the email to be sent to you. If you get an email asking you to click on a link to perform an action, such as resetting your password, and you didn't ask to reset your password, type the website address into your browser by yourself.
- **Don't respond to email messages that ask for personal information.** Legitimate companies will not use email messages to ask for your personal information. When in doubt, contact the company by phone or by typing in the company web address into your web browser. Don't click on the links in these messages as they make take you to fraudulent, malicious web sites.
- **Steer clear of fraudulent web sites used to steal personal information.** When visiting a web site, type the address (URL) directly into the web browser rather than following a link within an email or instant message. Fraudsters often forge these links to make them look convincing.
A shopping, banking or any other web site where sensitive information should have an "S" after the letters "http" (i.e. *https://*

www.yourbank.com not *http://www.yourbank.com*). The "s" stands for secure and should appear when you are in an area requesting you to login or provide other sensitive data. Another sign that you have a secure connection is the small lock icon in the bottom of your web browser (usually the right-hand corner).

- **Pay attention to privacy policies on web sites and in software.** It is important to understand how an organization might collect and use your personal information before you share it with them.
- **Guard your email address.** Spammers and "phishers" sometimes send millions of messages to email addresses that may or may not exist in hopes of finding a potential victim. Responding to these messages or even downloading images ensures you will be added to their lists for more of the same messages in the future. Also be careful when posting your email address online in newsgroups, blogs or online communities.

Online offers that look too good to be true usually are

The old saying "there's no such thing as a free lunch" still rings true today. Supposedly "free" software such as screen savers or smileys, secret investment tricks sure to make you untold fortunes, and contests that you've surprisingly won without entering are the enticing hooks used by companies to grab your attention.

While you may not directly pay for the software or service with money, the free software or service you asked for may have been bundled with advertising software ("adware") that tracks your behavior and displays unwanted advertisements. You may have to divulge personal information or purchase something else in order to claim your supposed content winnings. If an offer looks so good it's hard to believe, ask for someone else's opinion, read the fine print, or even better, simply ignore it.

Review bank and credit card statements regularly

The impact of identity theft and online crimes can be greatly reduced if you can catch it shortly after your data is stolen or when the first use of your information is attempted. One of the easiest ways to get the tip-off that something has gone wrong is by reviewing the monthly statements provided by your bank and credit card companies for anything out of the ordinary.

Additionally, many banks and services use fraud prevention systems that call out unusual purchasing behavior (i.e. if you live in Texas and all of the sudden start buying refrigerators in Budapest). In order to confirm these out of the ordinary purchases, they might call you and ask you to confirm them. Don't take these calls lightly; this is your hint that something bad may have happened and you should take necessary action.

Protect your computer with Windows security tools

Windows provides a variety of protection applications.

Windows Updates

If you have an active internet connection, Windows can check for important updates for your computer and install them automatically. These updates include security patches and program updates that can improve your computing experience and help protect your computer against new viruses and attacks.

How do I know when my computer is at risk?

If the *Action Center* reports an alert, or if your computer behaves erratically, crashes unexpectedly or if some of your programs do not work correctly, your computer may be infected by malicious software. However, do not blame every computer problem on a virus! If you suspect your computer is infected, the first thing to do is update, if you have not already done so, and run your antivirus and anti-spyware software.

PLAYING BLU-RAY OR DVD MOVIES

If your computer is equipped with a Blu-Ray or DVD drive, you can play movies on your computer or on a high-definition TV via HDMI.

1. Insert the disc into the drive.
2. After a few seconds, the movie will start playing.
3. If the movie does not start playing, open your movie playback program and open the disc from the *File* menu.



Important

When you launch the DVD player for the first time, the program asks you to enter the region code. DVDs are available for 6 regions.

Region code	Country or region
1	USA, Canada
2	Europe, Middle East, South Africa, Japan
3	Southeast Asia, Taiwan, South Korea
4	Latin America, Australia, New Zealand
5	Former USSR, parts of Africa, India
6	People's Republic of China



Note

To change the region code, insert a DVD movie of a different region into the DVD drive.

Once your DVD drive is set to a region code, it will only play DVDs for that region. You can set the region code a maximum of five times (including the first time), after which the last region code set will remain permanent.

Recovering your hard disk does not reset the number of times the region code has been set.