

SAMSUNG

USER MANUAL

SM-R220

English. 09/2020. Rev.1.1

www.samsung.com

Table of Contents

Getting Started

- 3 Read me first
- 8 Device layout
- 10 Battery
- 13 Wearing the Galaxy Fit2
- 15 Turning on the Galaxy Fit2
- 16 Connecting the Galaxy Fit2 to a mobile device
- 18 Controlling the screen
- 20 Screen composition

Galaxy Wearable app

- 47 Introduction
- 48 Home
- 56 Watch faces

Appendix

- 57 Troubleshooting
- 60 Removing the battery

Widgets and features

- 28 Messages
- 28 Answering calls
- 29 Health management widget
- 31 Health summary
- 31 Exercise
- 35 Steps
- 36 Stress
- 38 Heart rate
- 40 Sleep
- 41 Hand Wash
- 42 Water
- 43 Weather
- 44 Calendar
- 45 Stopwatch and timer
- 46 Music
- 46 Find My Phone

Getting Started

Read me first

Please read this manual before using this device to ensure safe and proper use.

- Descriptions are based on the device's default settings.
- Some content may differ from your device depending on the region, model specifications, or device's software.
- Samsung is not liable for performance issues or incompatibilities caused by edited registry settings or modified operating system software. Attempting to customise the operating system may cause the Galaxy Fit2 or apps to work improperly.
- Software, sound sources, wallpapers, images, and other media provided with this Galaxy Fit2 are licensed for limited use. Extracting and using these materials for commercial or other purposes is an infringement of copyright laws. Users are entirely responsible for illegal use of media.
- Default apps that come with the Galaxy Fit2 are subject to updates and may no longer be supported without prior notice. If you have questions about an app provided with the Galaxy Fit2, contact a Samsung Service Centre.
- Modifying the Galaxy Fit2's operating system or installing softwares from unofficial sources may result in Galaxy Fit2 malfunctions and data corruption or loss. These actions are violations of your Samsung licence agreement and will void your warranty.
- Some functions may not work as described in this manual depending on the maker and model of the mobile device you connect to the Galaxy Fit2.
- This product includes certain free/open source software. To see the instructions for viewing the open source licence, go to the Samsung website (opensource.samsung.com).

- Some functions may not be available depending on the region or service provider.
- Depending on the region or service provider, a screen protector is attached for protection during production and distribution. Damage to the attached screen protector is not covered by the warranty.
- Due to the nature of the product, displaying fixed graphics for extended periods may result in afterimages (screen burn-in) or ghosting.
 - It is recommended not to use fixed graphics on part or all of the touchscreen for extended periods and turn off the touchscreen when not using the device.
 - You can set the touchscreen to turn off automatically when you are not using it. Launch the **Galaxy Wearable** app on your mobile device that is connected to your Galaxy Fit2, tap **Home** → **Display** → **Screen timeout**, and then select the length of time you want the device to wait before turning off the touchscreen.
- Depending on the region or model, some devices are required to receive approval from the Federal Communications Commission (FCC).

If your device is approved by the FCC, you can view the FCC ID on the connected mobile device. To view the FCC ID, launch the **Galaxy Wearable** app on your mobile device that is connected to your Galaxy Fit2, tap **Home** → **About band** → **Device information**, and then check the FCC ID under **FCC certification**. If your device does not have an FCC ID, it means that the device has not been authorised for sale in the U.S. or its territories and may only be brought to the U.S. for the owner's personal use.

Maintaining water and dust resistance

Your device supports water- and dust-resistance. Follow these tips carefully to maintain the water- and dust-resistance of your device. Failure to do so may result in damage to your device.

- Do not expose the device to **water moving with force**.
- Do not use your device when you dive into the water, snorkel or try any water sports in fast-flowing water.
- If the device or your hands are wet, dry them thoroughly before handling the device.
- If the device is exposed to fresh water, dry it thoroughly with a clean, soft cloth. If the device is exposed to other liquids, such as salt water, swimming pool water, soapy water, oil, perfume, sunscreen, hand cleaner, or chemical products such as cosmetics, rinse it with fresh water and dry it thoroughly with a clean, soft cloth. If you do not follow these instructions, the device's performance and appearance may be affected.

- **If the device is dropped or receives an impact**, the water- and dust-resistant features of the device may be damaged.
- Do not disassemble your device. The water- and dust-resistant features of the device can be damaged.
- Do not expose your device to a dramatic change in air temperature or water temperature.
- Do not dry your device with a heating machine like a hair drier.
- The water-resistant feature of the device can be damaged in the sauna.
- Some features such as the touchscreen may not work properly **if the device is used in water**.
- **Your device has been tested in a controlled environment and certified to be water- and dust-resistant in specific situations and conditions. (Meets the requirements of the water-resistance in a 50 m deep water as described by the international standard ISO 22810:2010 and your device can be used in shallow water. Meets the requirements of the dust-resistance as described by classification IEC 60529 IP6X.)**

Precautions for overheating

If you feel discomfort due to overheating while using the device, stop using it immediately and remove it from your wrist.

To avoid problems, such as device malfunction, skin discomfort or damage, and battery draining, a warning will appear on the device if it reaches a specific temperature. When the initial warning appears, all device functions will be disabled until the device cools down to a specific temperature.

If the device temperature continues to increase, a second warning will appear. At this time, the device will shut down. Do not use the device until it cools down to a specific temperature.

Instructional icons



Warning: situations that could cause injury to yourself or others



Caution: situations that could cause damage to your device or other equipment



Notice: notes, usage tips, or additional information

Cleaning and managing the Galaxy Fit2

Follow the points below to ensure your Galaxy Fit2 functions correctly and maintains its appearance. Failure to do so may damage the Galaxy Fit2 and cause the skin irritation.

- Prevent the device from being exposed to dust, sweat, ink, oil, and chemical products such as cosmetics, antibacterial spray, hand cleaner, detergent, and insecticides. The Galaxy Fit2's exterior and interior parts may be damaged or it could result in poor performance. If your Galaxy Fit2 is exposed to any of the previously mentioned substances, use a lint-free, soft cloth to clean it.
- Do not use soap, cleaning agents, abrasive materials and compressed air when cleaning your Galaxy Fit2 and do not clean it with the ultrasonic waves or the external heat sources. Doing so may damage the Galaxy Fit2. Skin irritation may be caused by soap, detergents hand sanitizers, or cleaning agents left on the Galaxy Fit2.
- Clean your wrist and band after exercising or sweating. Clean the Galaxy Fit2 with freshwater, wipe it with a little rubbing alcohol and dry your Galaxy Fit2 thoroughly.
- When you remove sun block, lotion, or oil, use a soap-free detergent, then rinse and dry your Galaxy Fit2 thoroughly.
- If the Galaxy Fit2's band gets stained or contains any materials, wipe it with a moistened soft bristle toothbrush.

Use caution if you are allergic to any materials on the Galaxy Fit2

- Samsung has tested the noxious materials found on the Galaxy Fit2 through the internal and external certificate authorities, including the test for all materials which contact with skin, skin toxicity test, and the Galaxy Fit2-wearing test.
- The Galaxy Fit2 includes nickel. Take the necessary precautions if your skin is hypersensitive or you have an allergy to any materials found on the Galaxy Fit2.
 - **Nickel:** The Galaxy Fit2 contains a small amount of nickel, which is below its reference point limited by the Europe REACH regulation. You will not be exposed to the nickel inside the Galaxy Fit2 and the Galaxy Fit2 has passed the international certificated test. However, if you are sensitive to nickel, be careful to use the Galaxy Fit2.
- Only the materials observed the standards of the U.S Consumer Product Safety Commission (CPSC), the regulations of the European countries, and other international standards are used to make a Galaxy Fit2.
- For more information about how Samsung manages chemicals, refer to the Samsung website (<https://www.samsung.com/uk/aboutsamsung/sustainability/environment/>).

Device layout

Package contents

Refer to the quick start guide for package contents.



- The items supplied with the Galaxy Fit2 and any available accessories may vary depending on the region or service provider.
- The supplied items are designed only for this Galaxy Fit2 and may not be compatible with other devices.
- Appearances and specifications are subject to change without prior notice.
- You can purchase additional accessories from your local Samsung retailer. Make sure they are compatible with the Galaxy Fit2 before purchase.
- Except the Galaxy Fit2 and some accessories may not have the same water- and dust-resistance certification.
- Use only Samsung-approved accessories. Using unapproved accessories may cause the performance problems and malfunctions that are not covered by the warranty.
- Availability of all accessories is subject to change depending entirely on manufacturing companies. For more information about available accessories, refer to the Samsung website.

Galaxy Fit2

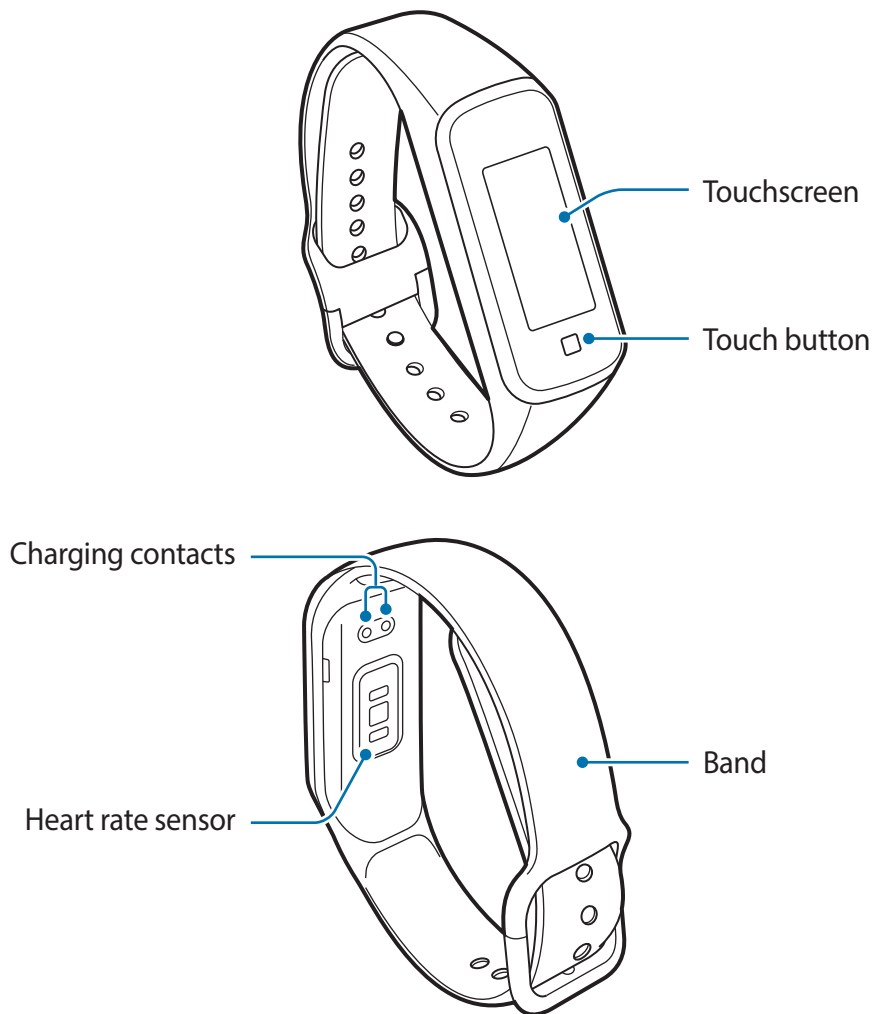



- Ensure that the band is kept clean. Contact with contaminants, such as dust and dye, can cause stains on the band that may not be fully removed.
- If you use the device with its glass or acrylic body broken, there may be a risk of injury. Use the device only after it has been repaired at a Samsung Service Centre.

Buttons

Button	Function
<input type="checkbox"/> Touch	<ul style="list-style-type: none">• Tap to turn on the screen.• Tap to open the Watch screen when you are on any other screen.

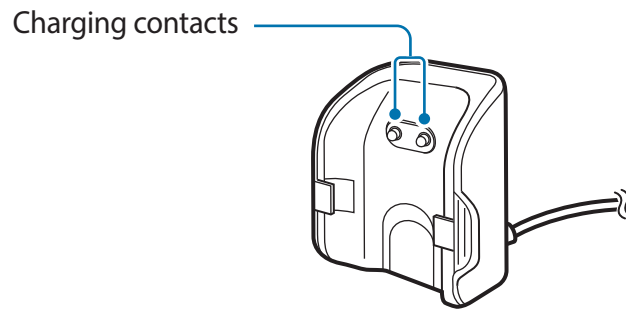
Charger





 Do not expose the charger to water because the charger does not have same water-resistance certification as your Galaxy Fit2.

Battery

Charging the battery

Charge the battery before using it for the first time or when it has been unused for extended periods.

 Use only Samsung-approved chargers, batteries, and cables. Unapproved chargers or cables can cause the battery to explode or damage the Galaxy Fit2.

-  • Use the supplied charger. The Galaxy Fit2 cannot be charged properly with a third-party charger.
- Connecting the charger improperly may cause serious damage to the device. Any damage caused by misuse is not covered by the warranty.

 To save energy, unplug the charger when not in use. The charger does not have a power switch, so you must unplug the charger from the electric socket when not in use to avoid wasting power. The charger should remain close to the electric socket and easily accessible while charging.

1 Connect the charging cable to the USB power adapter.

- 2 Align the centre of the charger with the Galaxy Fit2 and align the clasp of the charger with the notch next to the charging contacts of the Galaxy Fit2.

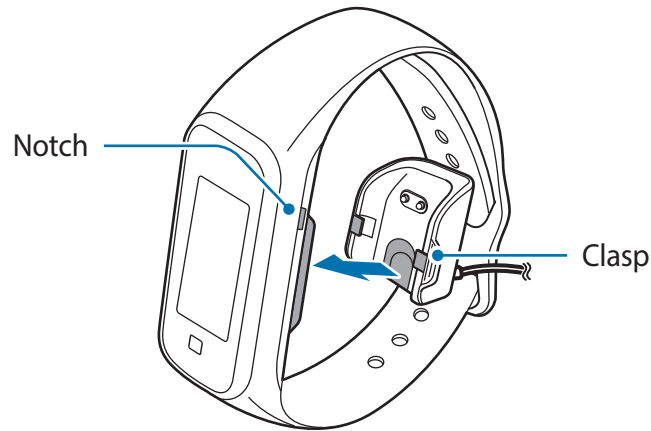

- 3 Press and hold the Galaxy Fit2 and charger until it clicks.

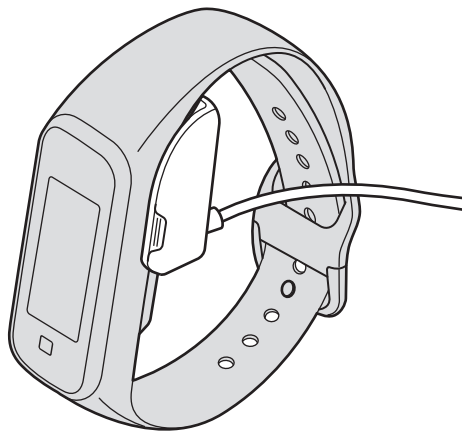

- 4 After fully charging your Galaxy Fit2, pull on the handle of the charger to disconnect it. Unplug the charger from the electric socket.

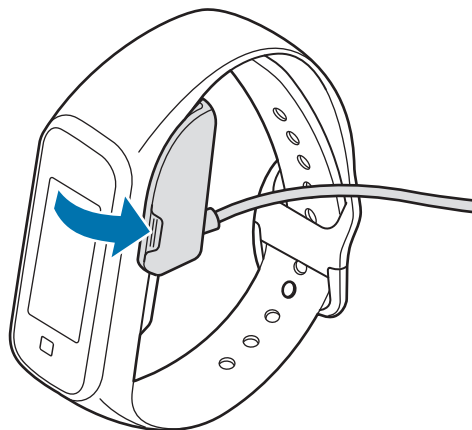

Reducing the battery consumption

Your Galaxy Fit2 provides options that help you conserve battery power.

- Customise the notification settings in **Galaxy Wearable** app on the mobile device.
- Deactivate the vibration feature in **Galaxy Wearable** app on the mobile device.

Battery charging tips and precautions

- After purchasing the Galaxy Fit2, connect the charger to turn on the power. You must first charge the battery sufficiently.
- If there are obstructions between the Galaxy Fit2 and the charger, the Galaxy Fit2 may not charge properly. Prevent the Galaxy Fit2 and the charger from coming into contact with sweat, liquids, or dust.
- If the battery is completely discharged, the Galaxy Fit2 cannot be turned on immediately when the charger is connected. Allow a depleted battery to charge for a few minutes before turning on the Galaxy Fit2.
- Using a power source other than the charger, such as a computer, may result in a slower charging speed due to a lower electric current.
- If the Galaxy Fit2 is being charged with other devices via a multi charger, charging may take longer.
- While charging the Galaxy Fit2's battery, only the current time and the battery level can be checked on the screen. However, some notifications that should be checked immediately, such as calls, will be received.
- If the Galaxy Fit2 receives an unstable power supply while charging, the touchscreen may not function. If this happens, disconnect the Galaxy Fit2 from the charger.
- While charging, the Galaxy Fit2 may heat up. This is normal and should not affect the Galaxy Fit2's lifespan or performance. If the battery gets hotter than usual, the charger may stop charging for your safety. If this happens, continue charging the Galaxy Fit2 after allowing it to cool down by removing it from the charger.
- If the Galaxy Fit2 is not charging properly, take the Galaxy Fit2 to a Samsung Service Centre.
- Avoid using a bent or damaged charging cable.

Wearing the Galaxy Fit2

Putting on the Galaxy Fit2

Open the buckle and place the band around your wrist. Push the band into the upper part of the buckle, insert the pin into the hole, and then push the end of the band into the lower part of the buckle to secure the Galaxy Fit2 to your wrist. Make sure to fasten the Galaxy Fit2 in the hole one further out than you normally would not to feel any discomfort as the band can be inadvertently tightened if the end of the band is pulled inward.

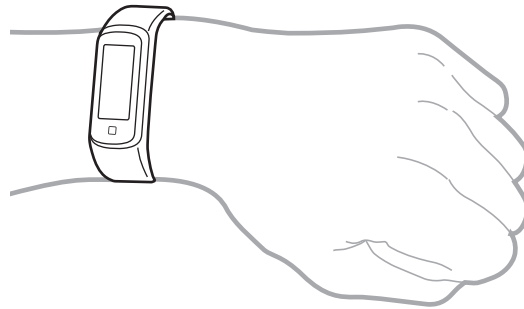

Do not bend the band excessively. Doing so may damage the Galaxy Fit2.



To measure your heart rate more accurately with the Galaxy Fit2, wear the Galaxy Fit2 firmly around your lower arm just above the wrist. Refer to [Wearing the Galaxy Fit2 correctly](#) for more information.

Band tips and precautions

- Be cautious when wearing the Galaxy Fit2. If you have sensitive skin or fasten the Galaxy Fit2 too tightly, you may feel some discomfort.
- Some people may experience discomfort when wearing the Galaxy Fit2 for prolonged periods.
- Skin irritation may occur due to an allergy, environment factors, other factors, or when your skin is exposed to soap or sweat for long periods.
- Do not wear the Galaxy Fit2 too tightly. Make sure to keep the device clean and dry. Though this device has met international safety standards, some people may experience skin irritation if they are allergic to certain substances.

Taking off the Galaxy Fit2

When taking off the Galaxy Fit2, remove the pin from the hole and pull up on the buckle while holding both sides.

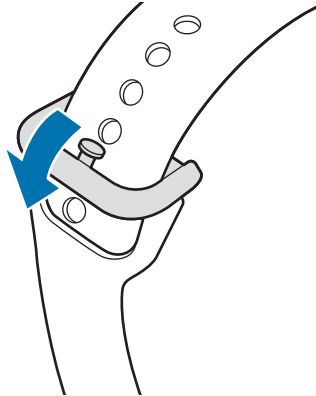

Detaching the band

To detach the band, while holding the Galaxy Fit2, gently pull on one of the band connections to lift it up.

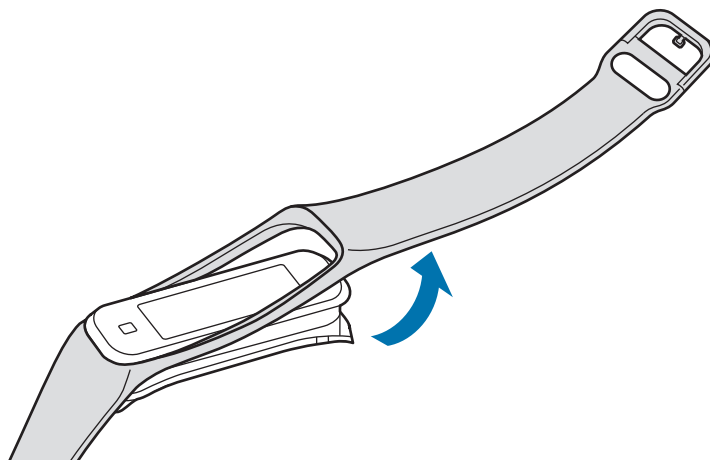

- Be sure to pull out the band close to the screen. Pulling the end of the band may damage the band.
- Keep the Galaxy Fit2 stable and remove the band. Otherwise, the Galaxy Fit2 may be damaged during band detachment.

To reattach the band, insert one side of the band into one side of the Galaxy Fit2 and gently pull out the opposite side of the band connection and then fit it to the other side of the Galaxy Fit2.

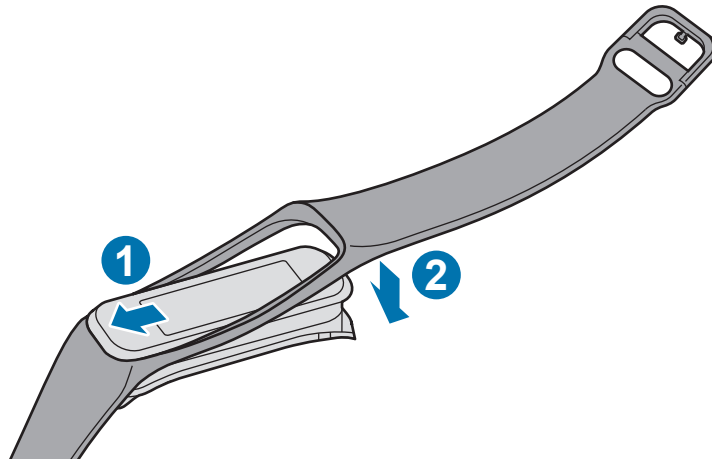

Turning on the Galaxy Fit2

Connect the Galaxy Fit2 to the charger to turn on the power.

When you turn on the Galaxy Fit2 for the first time or reset it, on-screen instructions will appear to launch the Galaxy Wearable app on your mobile device. Refer to [Connecting the Galaxy Fit2 to a mobile device](#) for more information.

The Galaxy Fit2 has no separate power key and is powered on when the battery is charged.



Follow all posted warnings and directions from authorised personnel in areas where the use of wireless devices is restricted, such as aeroplanes and hospitals.

Restarting the Galaxy Fit2

If your Galaxy Fit2 is frozen and unresponsive, tap  →  on the quick panel to restart it.

Connecting the Galaxy Fit2 to a mobile device

Installing the Galaxy Wearable app

To connect your Galaxy Fit2 to a mobile device, install the Galaxy Wearable app on the mobile device.

Depending on your mobile device, you can download the Galaxy Wearable app from the following places:

- Samsung Android devices: **Galaxy Store, Play Store**
- Other Android devices: **Play Store**



You cannot install the Galaxy Wearable app on the mobile devices that do not support Galaxy Fit2 syncing. Ensure that your mobile device is compatible with a Galaxy Fit2.

Connecting the Galaxy Fit2 to a mobile device via Bluetooth



Initial setup screen

Galaxy Fit2

- 1 Connect the Galaxy Fit2 to the charger.
- 2 After fully charging your Galaxy Fit2, place the Galaxy Fit2 near your mobile device.

Mobile device

- 3 Make sure the Bluetooth feature is activated.
- 4 Launch the **Galaxy Wearable** app.
If necessary, update the Galaxy Wearable app to the latest version.
- 5 Tap **Get started**.
- 6 Select your device on the screen.
If you cannot find your device, tap **Scan for nearby devices**.
- 7 Follow the on-screen instructions to complete the connection.
When completing the connection, the Watch screen will appear on the Galaxy Fit2's screen.



- Connection methods and screen may vary depending on your mobile device and software version.
- Supported mobile devices and features may vary depending on your region, service provider, and device manufacturer. Visit www.samsung.com to see compatible devices.
- To use all features of the Galaxy Fit2, update the Samsung Health app to the latest version.

Connecting the Galaxy Fit2 to a new mobile device

Connect your Galaxy Fit2 to other mobile devices. You can connect with other mobile devices that are not connected to your Galaxy Fit2. When you connect the Galaxy Fit2 to a new mobile device, the Galaxy Fit2 will be reset.

- 1 Launch the **Galaxy Wearable** app on your mobile device.
- 2 Tap  → **Disconnect**.

- 3 On your new mobile device, launch the **Galaxy Wearable** app to connect to your Galaxy Fit2.



If the mobile device you want to connect to is already connected to another device, launch the **Galaxy Wearable** app on your mobile device and tap  → **Connect new device** to connect with a new device.

Controlling the screen

Touchscreen



- Do not allow the touchscreen to come into contact with other electronic devices. Electrostatic discharges can cause the screen to malfunction.
- To avoid damaging the touchscreen, do not tap it with anything sharp or apply excessive pressure to it with your fingertips.
- It is recommended not to use fixed graphics on part or all of the touchscreen for extended periods. Doing so may result in afterimages (screen burn-in) or ghosting.



- The Galaxy Fit2 may not recognise touch inputs close to the edges of the screen, which are outside of the touch input area.
- It is recommended to use fingers when you use the touchscreen.
- The touchscreen may not be available when water lock mode is activated.

Tapping

To launch the feature, select a menu item, or press an on-screen button, tap it with your finger.

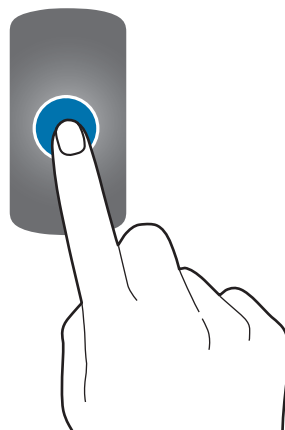

Swiping

Swipe to the left or right to view other screens.

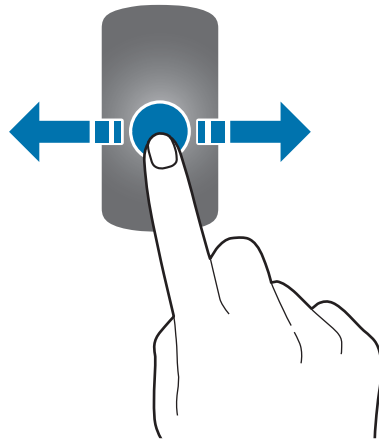

Dragging

To move an item, tap it and drag it to the target position.

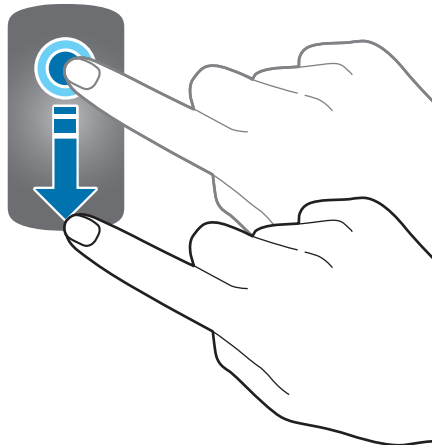

Screen composition

The Watch screen is the starting point for accessing all of the Galaxy Fit2's many screens. You can view other screens by swiping to the left or right on the screen.

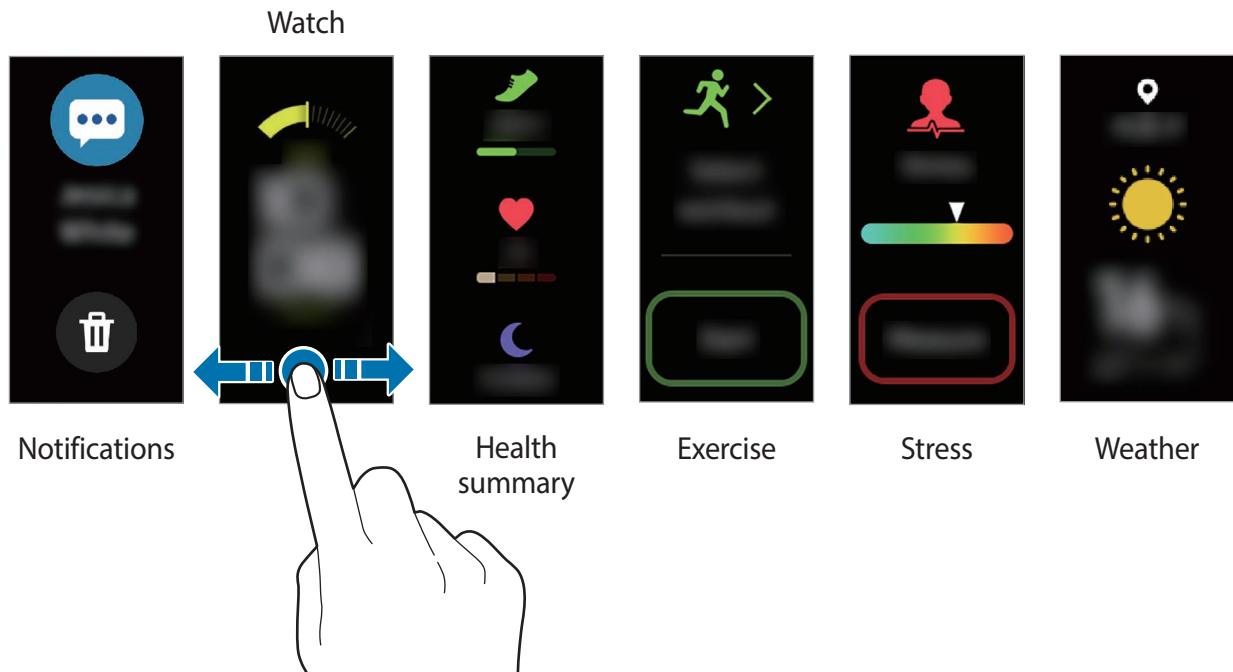

Available screens, widgets, and their arrangements may vary depending on the software version.

Turning the screen on and off

To turn on the screen, tap the Touch button.

To turn off the screen, cover it with your palm. Also, the screen will automatically turn off if the Galaxy Fit2 is not used for a specified period.

You can also turn on the screen using the wake-up gesture feature. On the mobile device, launch the **Galaxy Wearable** app, tap **Home** → **Advanced** → **Wake-up gesture**, and then tap the switch to activate it.

Watch screen

You can check the current time. You can also check your health information, such as your step count or heart rate.



To change the watch face, launch the **Galaxy Wearable** app on your mobile device, tap **Watch faces**, and then select a watch face you want.

Widget screen

You can instantly check your health and activity information and view app information, such as weather and schedules, for some connected mobile devices.

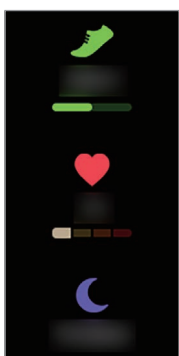

Health summary

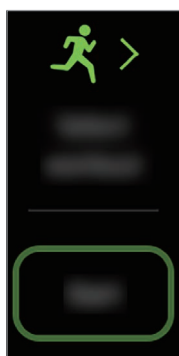

Exercise

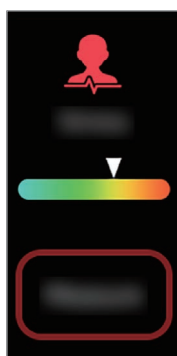

Stress

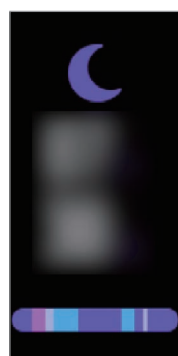

Sleep



Weather



Calendar

Notification panel

When an alarm sounds, or when there is a call, message, or notification from your mobile device, the Galaxy Fit2 will vibrate.

On the Watch screen, swipe to the right to open the notification panel to check a notification, such as a new message or a missed call. When there are unchecked notifications, an orange dot will be visible on the Watch screen.

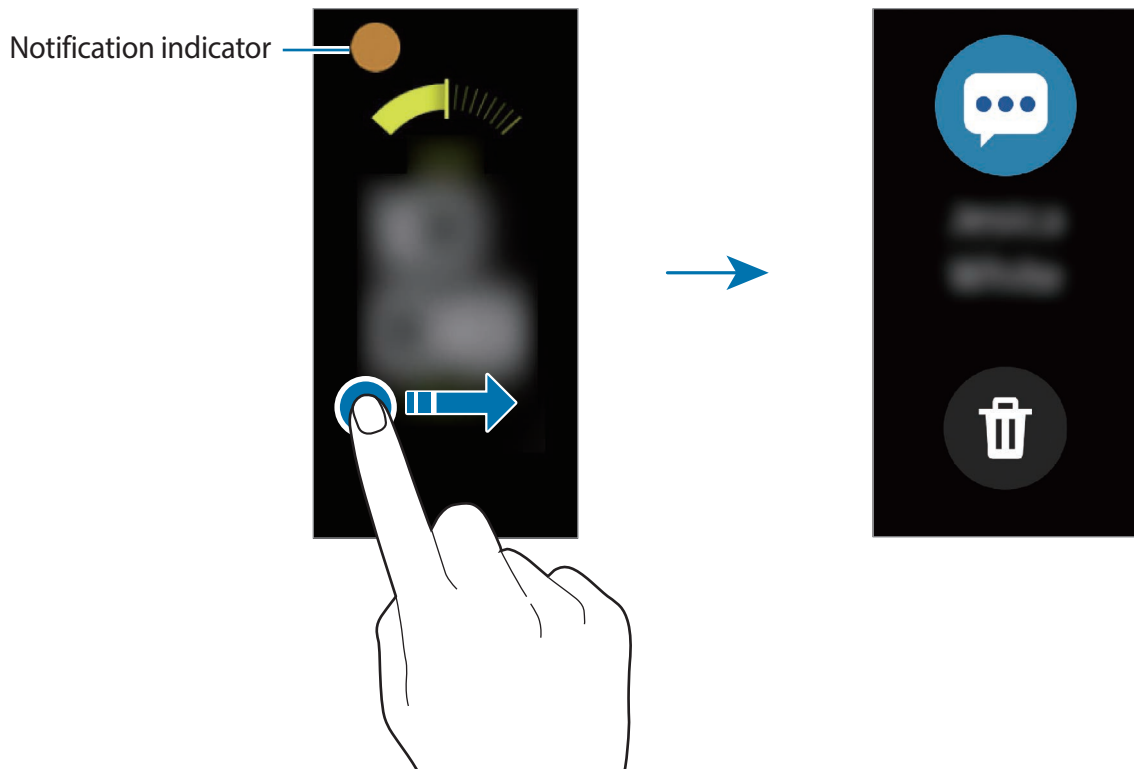

Checking notifications

When you receive a notification, information about the notification, such as its type or the time you received it, will appear on the screen.

Tap the notification to view details.

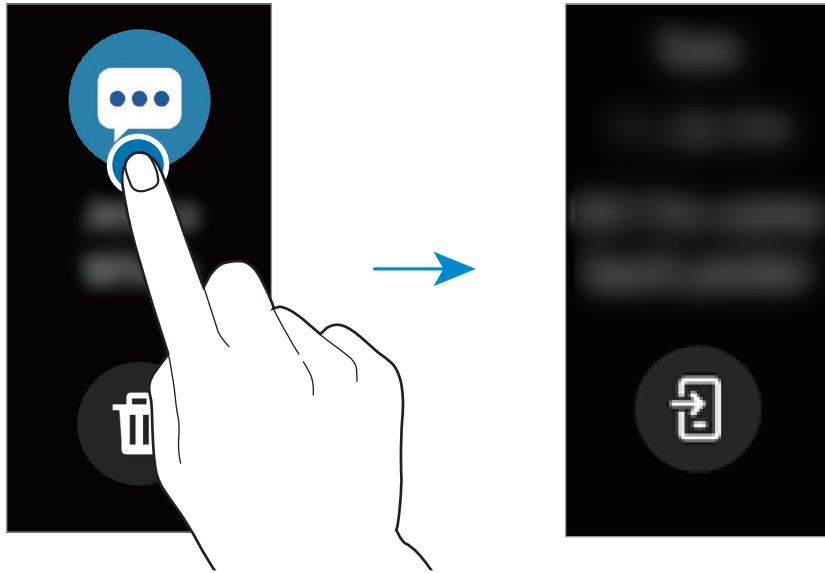

Blocking notifications

- 1 Launch the **Galaxy Wearable** app on your mobile device.
- 2 Tap **Home** → **Notifications**.
- 3 Tap the switch to deactivate it.
To block notifications by app, tap **See all** → ▼ → **All** and tap the switch next to an app.

Quick panel

This panel allows you to view the Galaxy Fit2's current status and configure settings. Swipe downwards from the top edge of the screen.

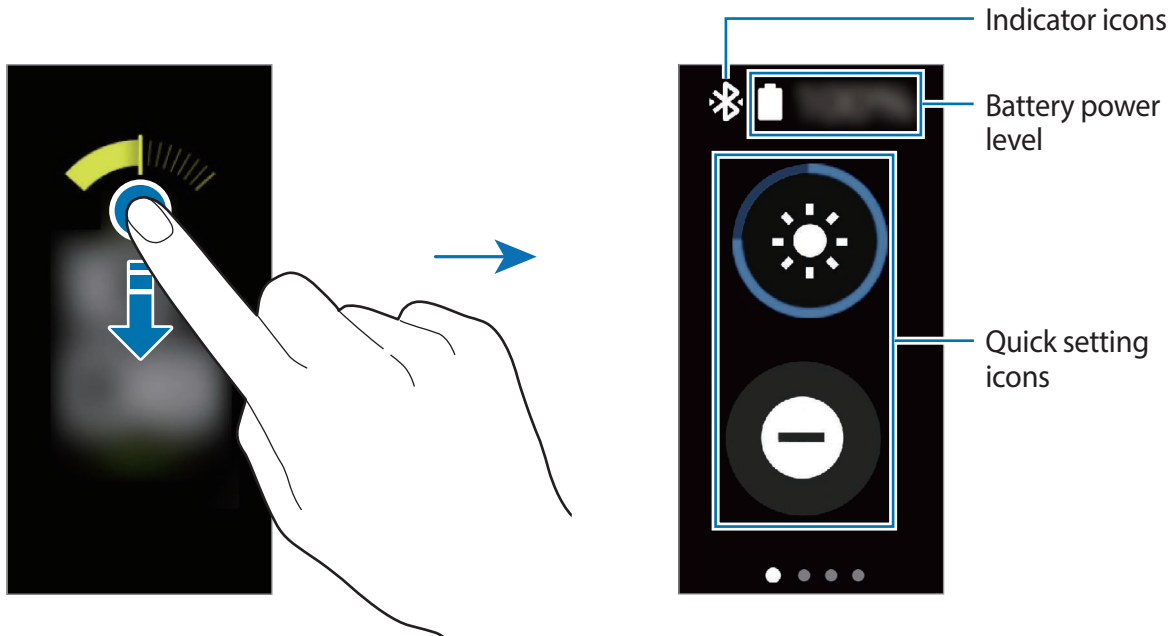

Checking the indicator icons

Indicator icons appear at the top of the quick panel and let you know the Galaxy Fit2's current status. The icons listed in the table below are most common.











The indicator icons shown may vary depending on the region.

Icon	Meaning
✱	Bluetooth connected
✱	Bluetooth disconnected
🔋	Battery power level

Checking quick setting icons

Quick setting icons appear on the quick panel. Tap the icon to change the basic settings or launch the function conveniently.



Icon	Meaning
	Adjust the brightness
	Activate do not disturb mode
	Control music playback
	Activate vibrate or silent mode
	Activate water lock mode
	Launch the find my phone feature
	Activate goodnight mode
	Restart the Galaxy Fit2
	Reset the Galaxy Fit2

Editing the quick settings icon

You can edit the icons on the quick panel.

Launch the **Galaxy Wearable** app on your mobile device and tap **Home** → **Advanced** → **Edit quick panel**.

Adding or removing quick setting icons

Tap  next to the quick setting icon to remove it or tap  next to the quick setting icon to add it and tap **Save**.

The quick setting icon will be added or removed from the quick panel of the Galaxy Fit2.

Reordering quick setting icons

Tap  next to a quick setting icon, drag it to another position, and then tap **Save**.

The quick setting icon's order will be changed on the quick panel of the Galaxy Fit2.

Adjusting the brightness

You can adjust the Galaxy Fit2's brightness as desired.

On the quick panel, tap  and adjust the brightness by tapping  or .

Activating do not disturb mode

Set the Galaxy Fit2 to mute all notifications except for alarms and the screen will not turn on when notifications are received.

On the quick panel, tap .

The  icon will appear at the top of the Watch screen.

Controlling music

Control music playback on your mobile device easily.

On the quick panel, tap .

Tap the icons on the controller to control playback.

Activating vibrate or silent mode

Activate vibrate or silent mode.

On the quick panel, tap  or .

Activating water lock mode

Activate water lock mode when you exercise in water.

On the quick panel, tap .

The touchscreen and the wake-up gesture feature will be deactivated automatically.

While the screen is turned on, tap the Touch button once and drag the icon upwards and downwards to exit water lock mode.

Launching the find my phone feature

Launch the find my phone feature and find your mobile device when you misplace it.

On the quick panel, tap .

The mobile device will emit sound and turn on the screen. Refer to [Find My Phone](#) for more information.

Activating goodnight mode

Activate goodnight mode for sleeping. All notifications except for alarms are muted and the screen will not turn on when notifications are received while sleeping. Also, the wake-up gesture feature will be deactivated automatically.

On the quick panel, tap .

The  icon will appear at the top of the Watch screen.

Restarting the Galaxy Fit2

If your Galaxy Fit2 is frozen and unresponsive, restart the Galaxy Fit2.

On the quick panel, tap  → .

Resetting the Galaxy Fit2

Reset the Galaxy Fit2 to perform a factory data reset.

On the quick panel, tap  → .

Widgets and features

Messages

View and reply to messages using the Galaxy Fit2.

Viewing and sending messages



You may incur additional charges for receiving messages while you are roaming.

- 1 Swipe the screen to the right on the Watch screen to open the notification panel and view a new message.
- 2 Swipe upwards or downwards on the screen and select a quick reply message.
The message will be sent.

Deleting messages

Swipe to the right on the Watch screen to open the notification panel, swipe upwards or downwards on the screen, and then tap .

Answering calls

You can check incoming calls and reject them.

Rejecting a call

You can reject incoming calls.

Tap  and drag it upwards when a call comes in.

Checking a missed call

If a call is missed, a notification will appear on the notification panel. Swipe to the right on the Watch Screen to open the notification panel and view the notification.

Health management widget

Introduction

You can check and manage your health status with various widgets, such as steps, exercise, or stress tracker. Also, the health management widgets help you cultivate healthy habits by recording your activity and how long you sleep.

You can view additional information and save and manage the data related to your health via the Samsung Health app on the mobile device that is connected to your Galaxy Fit2.



- Samsung Health features are intended only for leisure, well-being, and fitness purposes. They are not intended for medical use. Before using these features, read the instructions carefully.
- Any information that is obtained from use of the Galaxy Fit2 or the Fit2 Software or any application preloaded within may not be suitable, accurate, complete or reliable.

Wearing the Galaxy Fit2 correctly

- Launch the **Galaxy Wearable** app on your mobile device, tap **Home** → **Health settings** → **Auto heart rate settings**, and then select **Continuously** for how often to measure your heart rate. When measuring your heart rate, wear the Galaxy Fit2 snugly on your arm above your wrist as shown in the figure below.
- If you fasten the Galaxy Fit2 too tightly, the skin irritation may occur and if you fasten it too loosely, friction may occur.

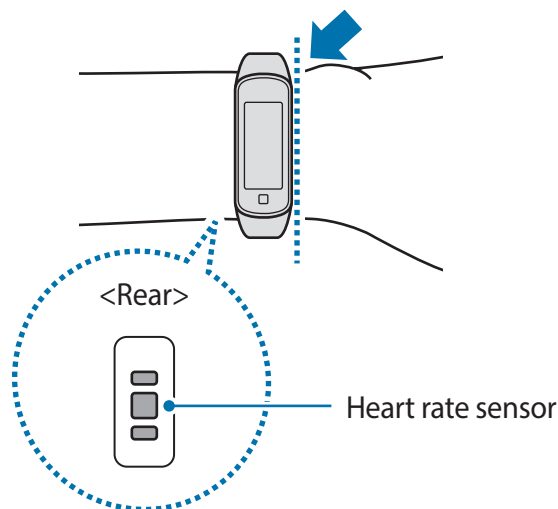



- The accuracy of the heart rate sensor may be diminished depending on measurement conditions and surroundings.
- Use the HR feature only for measuring your heart rate.
- Do not look directly at the heart rate sensor's lights. Doing so may impair your vision. Make sure children do not look directly at the lights.
- Cold ambient temperatures may affect your measurement; during winter or cold weather, keep yourself warm when checking your heart rate.
- Take heart rate measurements when you are seated and relaxed. Do not move your body while taking heart rate measurements. Doing so may cause your heart rate to be recorded inaccurately.
- If you receive a reading that is very different from your expected heart rate, rest and then measure again.
- Smoking or consuming alcohol before taking measurements may cause your heart rate to be different from your normal heart rate.
- Do not talk, yawn, or breathe deeply while taking heart rate measurements. Doing so may cause your heart rate to be recorded inaccurately.
- Because the heart rate sensor uses light to approximate heart rate, its accuracy may vary due to physical factors that affect light absorption and reflection, such as blood circulation/blood pressure, skin condition and location and concentration of blood vessels. In addition, if your heart rate is extremely high or low, measurements may be inaccurate.
- Users with thin wrists may receive inaccurate heart rate measurements when the device is loose, causing the light to be reflected unevenly. If heart rate measurement is not working properly, adjust the position of the device's heart rate sensor to the right, left, up, or down on your wrist, or turn the device so the heart rate sensor sits firmly against the inside of your wrist.
- If the heart rate sensor is dirty, wipe the sensor and try again. Obstructions between the device's band and your wrist, such as body hair, dirt, or other objects may prevent the light from reflecting evenly. Please make sure you remove such obstructions before use.
- If your device becomes hot to the touch, please remove it until it cools. Exposing skin to a hot surface of the device for a long time may cause skin burn.

Health summary

View your activity and health information, such as your daily step count, real-time heart rate, and sleep record.

Swipe to the left on the Watch screen to switch to the health summary widget screen.

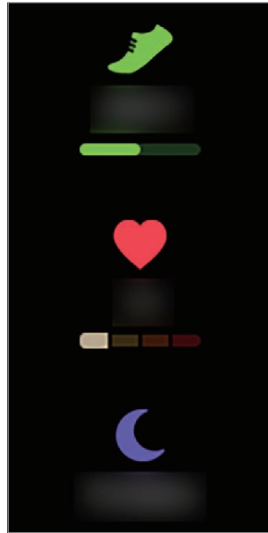

Swipe upwards or downwards on the screen to view your health information.

Exercise

Introduction

Record your exercise information and check the results, such as burned calories, with the exercise feature.



- Before using this feature, pregnant women, the elderly, and young children, users suffering from conditions, such as chronic heart disease or high blood pressure, are recommended to seek the advice of a licensed medical professional.
- If you feel dizzy, experience pain, or have difficulty breathing during exercise, stop using this feature and seek the advice of a licensed medical professional.
- If you have just purchased or have reset the Galaxy Fit2, create your profile.

Be aware of following conditions before exercising in cold weather conditions:

- Avoid using the device in cold weather. If possible, use the device indoors.
- If you use the device outside in cold weather, cover the Galaxy Fit2 with your sleeves before using it.

Starting the exercises

- 1 Swipe to the left on the Watch screen to switch to the exercise widget screen.
- 2 Tap the exercise type and select the exercise type you want from the list and start exercising.

When the exercise type you want is already selected, tap **Start** and start exercising.

When there is no exercise type you want, tap  to launch the **Samsung Health** app on your mobile device and add the exercise type displayed on your Galaxy Fit2.



- Your heart rate is measured in seconds when you start exercising. To measure your heart rate more accurately with the Galaxy Fit2, wear the Galaxy Fit2 firmly around your lower arm just above your wrist.
- Do not move until your heart rate displays on the screen so it can be measured more accurately.
- Your heart rate may not be visible temporarily due to various conditions such as the environment, your physical state, or how the Galaxy Fit2 is worn.
- When you select **Swimming**, water lock mode will be activated automatically.

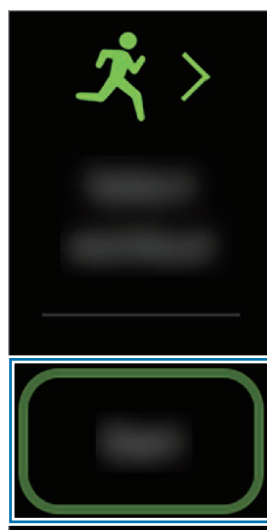

- 3 Swipe the screen to the left or right to view exercise information, such as your heart rate, distance, or time, on the workout screen.

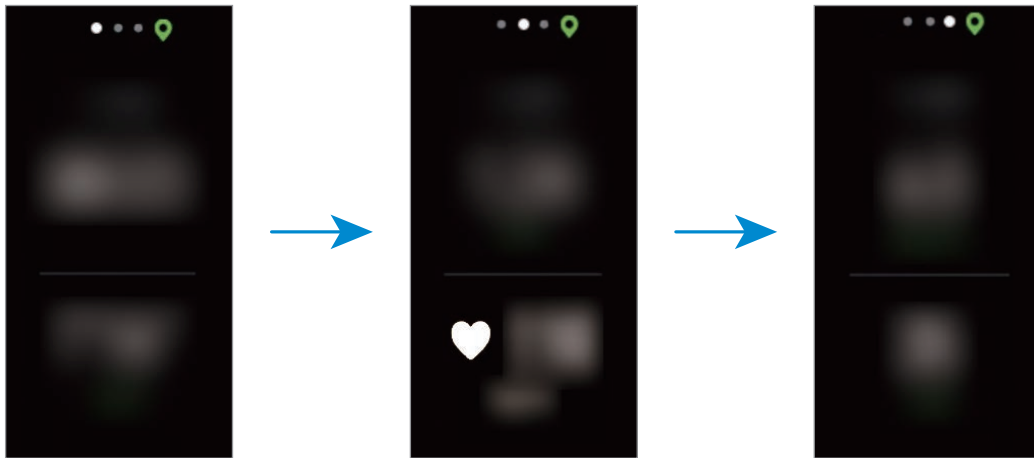

When you are swimming, you can check additional exercise information, such as your interval and stroke.



- When you select **Swimming**, water lock mode will be automatically activated and the touchscreen will be disabled. The screen will change automatically and you can check your exercise information.
- When you select **Swimming**, the recorded value may not be accurate in following cases:
 - If you stop swimming before reaching the completion point
 - If you change your swimming stroke midstream
 - If you stop moving your arms before reaching the completion point
 - If you kick with your legs on a kickboard or swim without moving your arms
 - If you do not pause or restart the exercise by tapping the Touch button, but finish the exercise by tapping the Touch button and tapping **Finish**

- 4 Tap the Touch button to pause the exercise.

To restart the exercise, tap the Touch button again after pausing the exercise.

To finish exercising, tap **Finish** after pausing the exercise.

To finish swimming, tap and hold the Touch button to deactivate water lock mode first, tap the Touch button again, and then tap **Finish**.

- 5 Swipe upwards or downwards on the screen after finishing the exercise and view your exercise information.

Doing multiple exercises

You can log various exercises and go straight through an entire routine by starting another exercise right after finishing the current exercise.

- 1 Tap the Touch button to pause the current exercise.
- 2 Tap **New**.
- 3 Select the exercise type and start the next exercise.

Automatic exercise recognition

Once you have engaged in an activity for more than ten minutes while wearing the Galaxy Fit2, it automatically recognises that you are exercising and records exercise information such as the exercise type, duration and calories burned.

When you stop doing some exercises for more than one minute, the Galaxy Fit2 automatically recognises that you have stopped exercising and this feature is deactivated. Check your exercise information via the Samsung Health app on the mobile device that is connected to your Galaxy Fit2.



- You can check the list of exercises which are supported by the automatic exercise recognition feature. Launch the **Galaxy Wearable** app on your mobile device and tap **Home** → **Health settings** → **Workout detection**.
- The automatic exercise recognition feature measures the distance travelled and calories burnt using the acceleration sensor. The measurements may not be accurate depending on your manner of walking, exercise routines, and lifestyle.

Steps

Introduction

The Galaxy Fit2 counts the number of steps you have taken and measures the distance travelled and the calories burned while walking.

Swipe to the left on the Watch screen to switch to the steps widget screen.

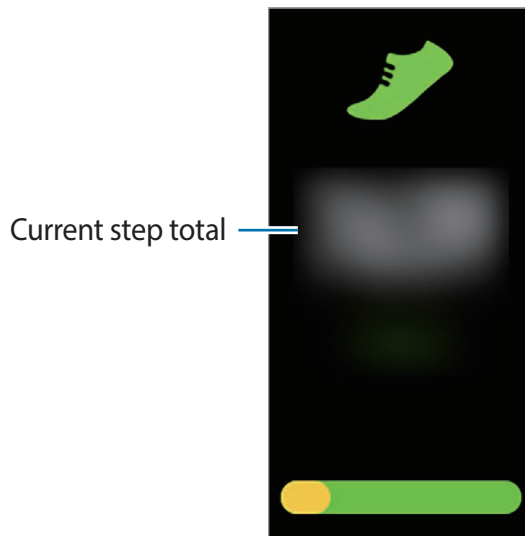

Swipe upwards or downwards on the screen to view your step information.



- When you start to measure your step, the step tracker monitors your steps and displays your step account after a brief delay because your Galaxy Fit2 accurately recognises your movement after you walk for a while. Also, for an accurate step count, you may experience a brief delay before the pop-up window indicates that a certain goal has been reached.
- If you use the steps tracker while travelling by car or train, vibration may affect your step count.
- You must first add the steps widget to use it. Launch the **Galaxy Wearable** app on your mobile device, tap **Home** → **Widgets**, tap **+** next to the steps widget, and then tap **Save**.

Setting the step target

Launch the **Galaxy Wearable** app on your mobile device and tap **Home** → **Health settings** → **Step target** to set a step target.

Stress

Introduction

Calculate and record your stress level by using changes in your heart rate and reduce your stress by following the breathing exercise that Galaxy Fit2 provides.



- You can get more accurate stress level results when your stress level data accumulates by measuring your stress levels automatically.
- Your measured stress level is not necessarily related to your emotional state.
- Your stress level may not be measured while you are sleeping, working out, moving a lot, or immediately after you finish a workout.
- To measure your heart rate more accurately with the Galaxy Fit2, wear the Galaxy Fit2 firmly around your lower arm just above the wrist. Refer to [Wearing the Galaxy Fit2 correctly](#) for more information.
- This feature may not be available depending on the region.

Measuring your stress level

1 Swipe to the left on the Watch screen to switch to the stress widget screen.

2 Tap **Measure** to start measuring your stress level.

After a moment, your current stress level will be displayed on the screen.

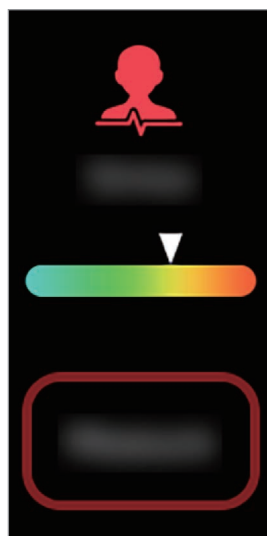

Swipe upwards or downwards on the screen to view your stress level information.



Tracking your stress level

The Galaxy Fit2 measures and records your stress level at regular intervals throughout your day.

- 1 Launch the **Galaxy Wearable** app on your mobile device, tap **Home** → **Health settings**, and then tap the **Auto stress settings** switch to activate it.
- 2 Swipe to the left on the Watch screen to switch to the stress widget screen.
- 3 After a moment, swipe upwards or downwards on the screen to view your stress level information.

Alleviating the stress

You can reduce stress by following the breathing exercise with Galaxy Fit2 for 5 minutes every day.

- 1 Swipe to the left on the Watch screen to switch to the stress widget screen, swipe upwards on the screen, and then tap **Breathe**.
- 2 Tap  and start to follow the breathing exercise.
To stop to breathe, tap .

Heart rate

Introduction

Measure and record your heart rate.



- The Galaxy Fit2's heart rate tracker is intended for fitness and informational purposes only and is not intended for use in the diagnosis of disease or other conditions, or in the cure, mitigation, treatment, or prevention of disease.
- To measure your heart rate more accurately with the Galaxy Fit2, wear the Galaxy Fit2 firmly around your lower arm just above the wrist. Refer to [Wearing the Galaxy Fit2 correctly](#) for more information.
- The Galaxy Fit2 can be used as a heart rate measurement accessory. Connect the Galaxy Fit2 and your mobile device, tap exercise tracker in the Samsung Health app on your mobile device to start exercising. You can see your heart rate measurements via the exercise screen, the exercise tracker results, and the heart rate tracker.
- You must first add the heart rate widget to use it. Launch the **Galaxy Wearable** app on your mobile device, tap **Home** → **Widgets**, tap  next to the heart rate widget, and then tap **Save**.

Be aware of following conditions before measuring your heart rate:

- If the measurement is very different from the expected heart rate, rest and then measure it again.
- During winter or in cold weather, keep yourself warm when measuring your heart rate.
- Smoking or consuming alcohol before taking measurements may cause your heart rate to be different from your normal heart rate.
- Do not talk, yawn, or breathe deeply while taking heart rate measurements. Doing so may cause your heart rate to be recorded inaccurately.
- Heart rate measurements may vary depending on the measurement method and the environment they are taken in.
- If the heart rate sensor is not working, check the Galaxy Fit2 on your wrist and make sure nothing is obstructing the sensor. If the heart rate sensor continues to have the same problem, visit a Samsung Service Centre.

Tracking your heart rate

The Galaxy Fit2 measures and records your heart rate at regular intervals throughout the day. Swipe to the left on the Watch screen to switch to the heart rate widget screen.

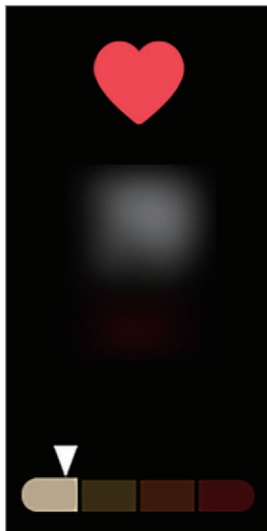

After a moment, swipe upwards or downwards on the screen to view your heart rate information.

Measuring your heart rate

You can measure your heart rate manually whenever you want.

- 1 Launch the **Galaxy Wearable** app on your mobile device, tap **Home** → **Health settings** → **Auto heart rate settings**, and then select **Manual measurement only**.
- 2 Swipe to the left on the Watch screen to switch to the heart rate widget screen.
- 3 Tap **Measure** to start measuring your heart rate.
After a moment, your current heart rate will be displayed on the screen.
- 4 Swipe upwards or downwards on the screen to view your heart rate information.

Sleep

Introduction

Record how long you sleep by analysing your movement while you are sleeping.



- To measure your heart rate more accurately with the Galaxy Fit2, wear the Galaxy Fit2 firmly around your lower arm just above the wrist. Refer to [Wearing the Galaxy Fit2 correctly](#) for more information.
- You must first add the sleep widget to use it. Launch the **Galaxy Wearable** app on your mobile device, tap **Home** → **Widgets**, tap **+** next to the sleep widget, and then tap **Save**.

Checking your sleep record

The Galaxy Fit2 measures your sleep record when you sleep while wearing the Galaxy Fit2.

Swipe to the left on the Watch screen to switch to the sleep widget screen after you wake up.

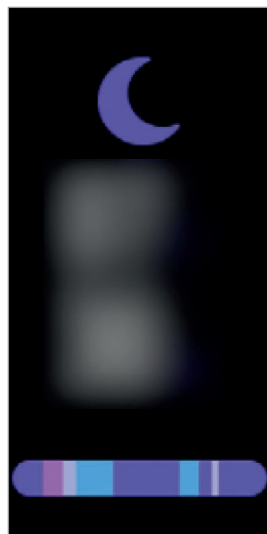

Swipe upwards or downwards on the screen to view your sleep information.



- You can view your sleep patterns and information via the Samsung Health app on the mobile device that is connected to your Galaxy Fit2.
- The sleep pattern will have its four states (Awake, REM, Light, Deep) analysed by using your movement and changes in your heart rate.
- If your heart rate is irregular, your Galaxy Fit2 cannot recognise your heart rate properly, the sleep pattern will be analysed into three states (Restless, Light, Motionless).

Hand Wash

You can view the number of times you wash your hands per day and a timer will appear to help make sure you wash your hands for a certain amount of time. You can also set reminders to tell you when it is time to wash your hands.

- 1 Swipe to the left on the Watch screen to switch to the hand wash widget screen.
- 2 Tap **Wash now** to wash your hands.
The 25-second timer will start.

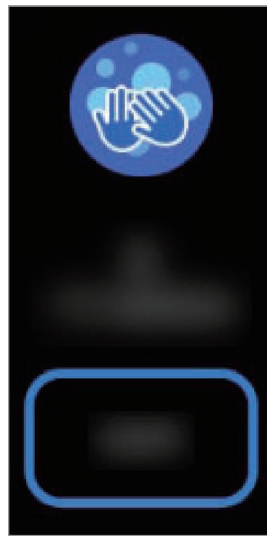

To receive reminders to wash your hands, you must set them up. Refer to [Hand Wash](#) for more information.

Water

Introduction

Record and track how many glasses of water you drink.



You must first add the water widget to use it. Launch the **Galaxy Wearable** app on your mobile device, tap **Home** → **Widgets**, tap **+** next to the water widget, and then tap **Save**.

Recording water consumption

- 1 Swipe to the left on the Watch screen to switch to the water widget screen.
- 2 Tap **+** when you drink a glass of water.
If you accidentally added an incorrect value, you can fix it by tapping **-**.



Weather

You can view weather information on the Galaxy Fit2 for locations set on the connected mobile device.

Swipe to the left on the Watch screen to switch to the weather widget screen.



Calendar

You can check the schedules of events that you saved on your mobile device on your Galaxy Fit2.

Swipe to the left on the Watch screen to switch to the calendar widget screen.

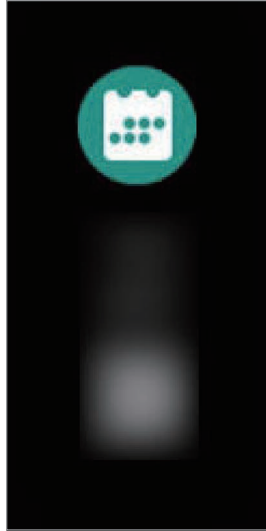



- All events scheduled on your mobile device will be synced with the connected Galaxy Fit2 automatically to check them, and receive alarms from the Galaxy Fit2.
- You must first add the calendar widget to use it. Launch the **Galaxy Wearable** app on your mobile device, tap **Home** → **Widgets**, tap **+** next to the calendar widget, and then tap **Save**.

Stopwatch and timer

Using the stopwatch

- 1 Swipe to the left on the Watch screen to switch to the stopwatch and timer widget screen.
- 2 Tap .
- 3 Tap **Start** to time an event.
- 4 Tap **Stop** to stop timing.
Tap **Resume** to restart the timing.
Tap **Reset** to return the stopwatch to the default setting.

Using the timer

- 1 Swipe to the left on the Watch screen to switch to the stopwatch and timer widget screen.
- 2 Tap .
- 3 Set the duration and tap .
- 4 Tap  and drag it upwards when the timer goes off.

Music

Control music playback on your mobile device easily.

Swipe to the left on the Watch screen to switch to the music widget screen.

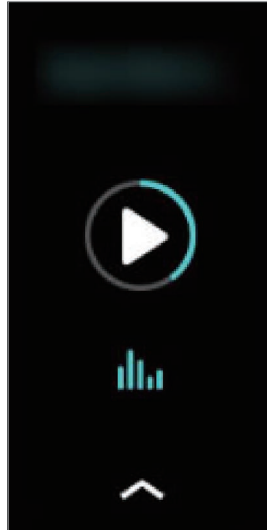

Tap the icons on the controller to control playback.



You must first add the music widget to use it. Launch the **Galaxy Wearable** app on your mobile device, tap **Home** → **Widgets**, tap **+** next to the music widget, and then tap **Save**.

Find My Phone

If you misplace the mobile device, the Galaxy Fit2 can help you find it.

1 Swipe downwards on the screen to open the quick panel.

2 Tap .

The mobile device emits sounds and turns on the screen. Tap  and drag it to the left or right on your mobile device, or tap **Stop** on the Galaxy Fit2.

Galaxy Wearable app

Introduction

To connect your Galaxy Fit2 to a mobile device, you must install the Galaxy Wearable app on your mobile device. In the Galaxy Wearable app, you can view the Galaxy Fit2's information and customise its various settings, such as your notification settings.

Launch the **Galaxy Wearable** app on your mobile device.



Some features may not be available depending on the type of connected mobile device.

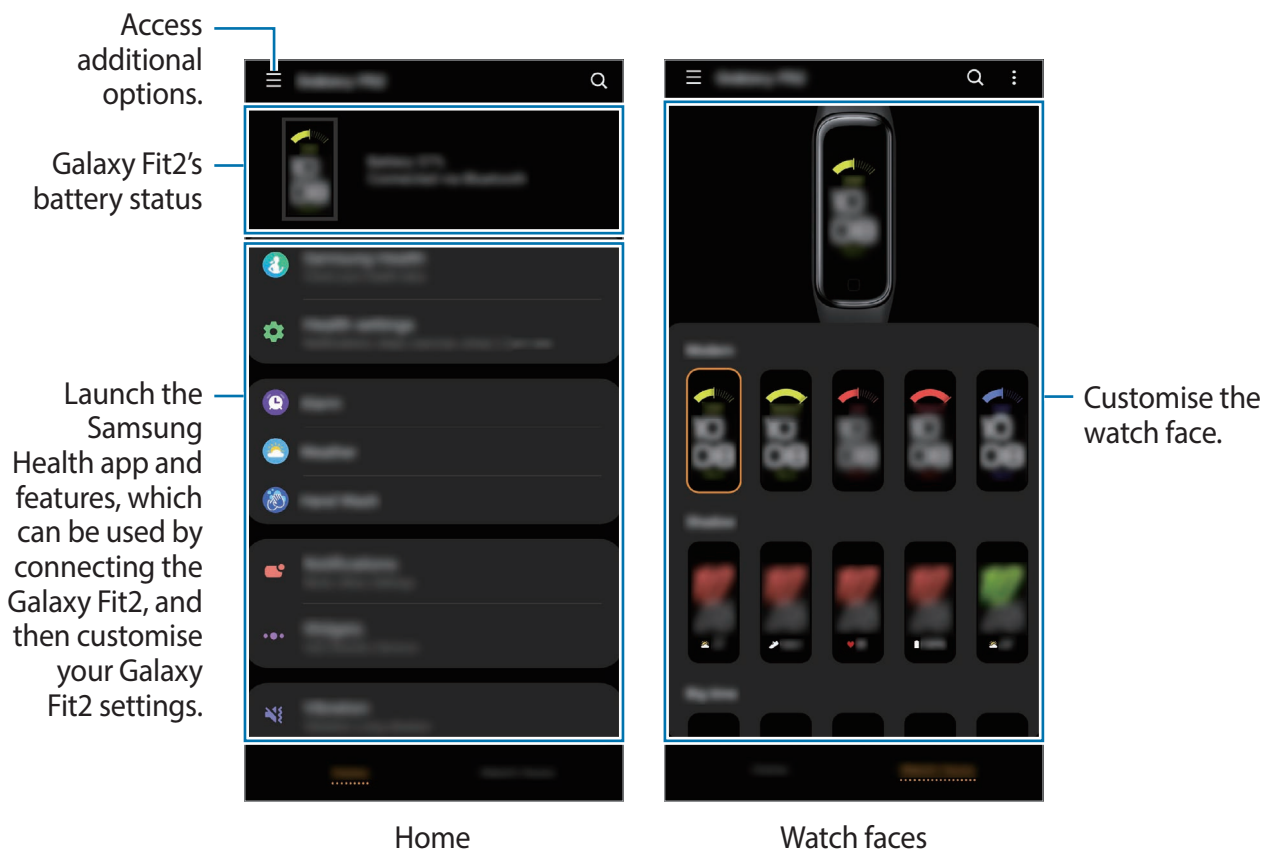

Tap  to use the following options:

- **Connect new device:** Disconnect your device from the currently connected mobile device and connect a new device. Select your device on the screen or tap **Scan for nearby devices** if you cannot find your device, and then follow the on-screen instructions to connect to the new device.
- **Disconnect:** Disconnect your Galaxy Fit2 from the currently connected mobile device.
- **App notifications:** Change the various Galaxy Wearable app notification settings on the mobile device.
- **Contact us: Samsung Members** offers support services to customers, such as device problem diagnosis, and lets users submit questions and error reports. You can also share information with others in the Galaxy users' community or view the latest Galaxy news and tips. **Samsung Members** can help you solve any problems you might encounter while using your device.



This option may not be available depending on the region, service provider or model that does not support the **Samsung Members** app.

- **About Galaxy Wearable:** View version information of the Galaxy Wearable app.

Home

Introduction

View your Galaxy Fit2's status and customise your Galaxy Fit2 settings. You can also launch the Samsung Health app by connecting the Galaxy Fit2 with your mobile device.

Launch the **Galaxy Wearable** app on your mobile device and tap **Home**.

Samsung Health

View the Galaxy Fit2's data saved in the Samsung Health app.

Launch the **Galaxy Wearable** app on your mobile device and tap **Home** → **Samsung Health**.

Health settings

View the Galaxy Fit2's health data saved in the Samsung Health app and change the health settings.

Launch the **Galaxy Wearable** app on your mobile device and tap **Home** → **Health settings**.



If the Samsung Health app installed on your mobile device is removed, the saved health data will be also removed and the health settings will be reset.

- **Notifications:** Turn the detecting workout time, inactive time, high heart rate, and step target achievement notifications on or off.
- **Step target:** View or change the step target you saved to the Samsung Health app.
- **Manage exercises:** Add or remove the exercise type displayed on your Galaxy Fit2. You can select up to ten exercise types.
- **Workout detection:** Set your Galaxy Fit2 to recognise your workout automatically.
- **Keep screen on during exercise:** Set the Galaxy Fit2 display the screen shows the exercise information while working out.
- **Auto stress settings:** Set the Galaxy Fit2 to automatically measure and record your stress level at regular intervals throughout your day.
- **Breathe settings:** Change the breathing exercise settings provided by the Galaxy Fit2.
- **Auto heart rate settings:** Set the Galaxy Fit2's auto heart rate measuring frequency.
- **High heart rate alert:** Select the resting heart rate and turn on the notification that alerts you when your resting heart rate is higher than the selected heart rate while inactive.



This feature is available only when the **Auto heart rate settings** feature is set to **Continuously**.

Alarm

Set alarms and manage them.

Setting alarms

1 Launch the **Galaxy Wearable** app on your mobile device.

2 Tap **Home** → **Alarm** → **Add alarm**.

If you have a saved alarm, tap **+** on the top of the alarms list.

- 3 Set the alarm time, select the days for the alarm to repeat, and then tap **Save**.

The saved alarm is added to the alarm list, and the Galaxy Fit2 vibrates at the set time.

To activate or deactivate alarms, tap the switch next to the alarm in the alarms list.

Stopping alarms

When the alarm sounds, tap  and drag it upwards on your Galaxy Fit2.

Deleting alarms

In the alarms list, tap and hold an alarm, and then tap **Delete**. Alternatively, tap  at the top of the screen, select the alarm you want to delete, and then tap **Delete**.

Weather

Change settings related to the weather information displayed on the weather widget screen of the Galaxy Fit2.

Launch the **Galaxy Wearable** app on your mobile device, tap **Home** → **Weather** → **Settings** to change settings, such as the temperature unit, the weather update interval, or using the current location.

Hand Wash

Set the Galaxy Fit2 to remind you to wash your hands at a specified interval. Keep your hands clean, stay safe, and help prevent the spread of contagious diseases.

- 1 Launch the **Galaxy Wearable** app on your mobile device.

- 2 Tap **Home** → **Hand Wash** → **Reminders**.

- 3 Set the details, such as time and interval, and tap **Save**.

When the Galaxy Fit2 sends a reminder to wash your hands, tap **Wash now** to start the 25-second timer.

Notifications

Change settings for the notification feature. Stay up to date with a variety of events, such as new messages received on the mobile device.

Launch the **Galaxy Wearable** app on your mobile device, tap **Home** → **Notifications**, tap the switch to activate it, and then activate items.

- **Show only while wearing:** Set the Galaxy Fit2 to show notifications only while you are wearing it.
- **Show while using phone:** Set the Galaxy Fit2 to show notifications while using your mobile device.
- **Turn on for new apps:** Set the Galaxy Fit2 to show notifications automatically for newly installed apps on your mobile device.
- **See all notification settings:** View the apps that received recent notifications and change the notification settings. To customise notification settings for more apps, tap **See all** → ▼ → **All** and select an app from the apps list.

Widgets

Customise the widgets on the Galaxy Fit2. You can also rearrange widgets.

Launch the **Galaxy Wearable** app on your mobile device and tap **Home** → **Widgets**.

Adding or removing widgets

Tap  next to the widget to remove it or tap  next to the widget to add it and tap **Save**.

The widget will be added or removed from the Galaxy Fit2.

Reordering widgets

Tap  next to a widget, drag it to another position, and then tap **Save**.

The widget's order will be changed on the Galaxy Fit2.

Vibration

Change the Galaxy Fit2's vibration settings. Even when vibration is turned off, some notifications can cause vibrations.

Launch the **Galaxy Wearable** app on your mobile device and tap **Home** → **Vibration**.

- **Vibration:** Turn vibrations on or off.
- **Long vibration:** Set the Galaxy Fit2 to vibrate longer for incoming calls and notifications.

Display

Change the Galaxy Fit2's display settings.

Launch the **Galaxy Wearable** app on your mobile device and tap **Home** → **Display**.

- **Brightness:** Adjust the brightness for the display.
- **Screen timeout:** Set the length of time the Galaxy Fit2 waits before turning off the display's backlight.

Advanced

Activate the Galaxy Fit2's advanced features and change the control settings.

Launch the **Galaxy Wearable** app on your mobile device and tap **Home** → **Advanced**.

- **Wake-up gesture:** Set the Galaxy Fit2 to turn on the screen when you raise your wrist that is wearing the Galaxy Fit2.

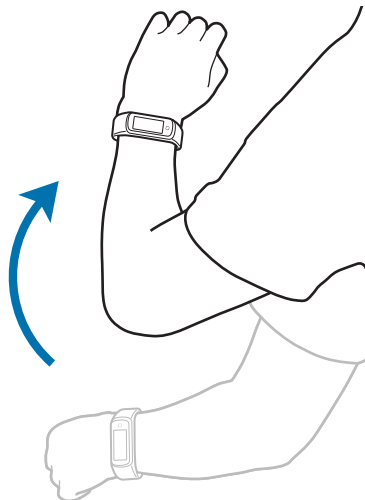

- **Water lock:** Activate water lock mode before entering the water. The touchscreen and the wake-up gesture feature will be deactivated automatically.
- **Sync Do not disturb with phone:** Set the Galaxy Fit2 to activate do not disturb mode automatically when it is activated on the connected mobile device.
- **Good night mode:** Activate goodnight mode for sleeping. All notifications except for alarms are muted and the screen will not turn on when notifications are received while sleeping. Also, the wake-up gesture feature will be deactivated automatically.
- **Edit quick panel:** Edit the Galaxy Fit2's quick panel.
- **Alert:** Set to receive an alert when the Bluetooth connection between the mobile device and Galaxy Fit2 is deactivated.

Quick responses

Edit or add templates used to reply to messages.

- 1 Launch the **Galaxy Wearable** app on your mobile device.
- 2 Tap **Home** → **Quick responses**.
- 3 Select a template to edit.
To add a template, tap .
- 4 Enter the template and tap **Save**.

Find My Band

If you misplace your Galaxy Fit2, use the Galaxy Wearable app on your mobile device to find it.

- 1 Launch the **Galaxy Wearable** app on your mobile device and tap **Home** → **Find My Band**.
- 2 Tap **Start**.
The Galaxy Fit2 will vibrate and the screen will turn on. To stop vibrating, tap  and drag it upwards on your Galaxy Fit2, or tap **Stop** on the mobile device.

Account and backup

Back up or restore your Galaxy Fit2's data using Samsung Cloud, provided by Samsung. Also, you can check the Samsung account registered on your connected mobile device and set up the customisation service.

Launch the **Galaxy Wearable** app on your mobile device and tap **Home** → **Account and backup**.

- **Samsung account:** Add your Samsung account to use with your Galaxy Fit2.
- **Auto back up / Back up data / Restore data / Delete backup:** Keep your personal information, data, and settings safe on your Galaxy Fit2. You can back up your sensitive information and access it later. You must sign in to your Samsung account to back up or restore data. Refer to [Managing the data in the Galaxy Fit2](#) for more information.
- **Customisation Service:** Set the Galaxy Fit2 to provide the proper feature depending on the location and situation after analysing your lifestyle pattern.



Regularly back up your data to a safe location, such as Samsung Cloud or a computer, so that you can restore it if the data is corrupted or lost due to an unintended factory data reset.

Managing the data in the Galaxy Fit2

Keep your personal information, data, and settings safe on your Galaxy Fit2. You can back up your sensitive information and access it later, as well as back up your Galaxy Fit2's data automatically.



Galaxy Fit2 data will be automatically saved on the connected mobile device's Samsung Health app. Only records from the past 7 days are saved on the Galaxy Fit2.

Backing up data automatically

To automatically back up data saved in your Galaxy Fit2 with Samsung Cloud and access it from other devices whenever you want, launch the **Galaxy Wearable** app on your mobile device, tap **Home** → **Account and backup**, and then tap the **Auto back up** switch to activate it.

Backing up data

To back up data saved in your Galaxy Fit2, launch the **Galaxy Wearable** app on your mobile device, tap **Home** → **Account and backup** → **Back up data**, select the item to back up, and then tap **Back up**. The data will be saved in Samsung Cloud.

Restoring data

To restore data saved in your Galaxy Fit2, launch the **Galaxy Wearable** app on your mobile device, tap **Home** → **Account and backup** → **Restore data**, select the item to restore, and then tap **Restore**. The latest backup data will be restored.

Deleting data

To delete data saved in your Galaxy Fit2, launch the **Galaxy Wearable** app on your mobile device, tap **Home** → **Account and backup** → **Delete backup**, select the item to delete, and then tap **Delete**. The backup data will be deleted.

Band software update

Update the Galaxy Fit2 to the latest software.

Updating software via the Galaxy Wearable app

The Galaxy Fit2 can be directly updated to the latest software by the firmware over-the-air (FOTA) service.

- 1 Launch the **Galaxy Wearable** app on your mobile device.
- 2 Tap **Home** → **Band software update** → **Download and install**.
- 3 Tap **Update** and install the latest software version on your mobile device.
- 4 When the Galaxy Fit2 is updated with the latest software, the Galaxy Fit2 will automatically copy the updated software from your mobile device and restart.

Tips and user manual

View help information to learn how to use the Galaxy Fit2 and apps or configure important settings.

Launch the **Galaxy Wearable** app on your mobile device, tap **Home** → **Tips and user manual**.

About band

View your Galaxy Fit2's status and other information. You can also update the Galaxy Fit2's software.

Launch the **Galaxy Wearable** app on your mobile device, tap **Home** → **About band**.

- **Device information:** Check the Galaxy Fit2's information, such as the Bluetooth address and serial number.
- **Legal information:** View the legal information for the Galaxy Fit2.
- **Software information:** View the Galaxy Fit2's software information, such as its operating system version and firmware version.
- **Battery information:** View the Galaxy Fit2's voltage and battery capacity.
- **Reset band:** Delete all data on your Galaxy Fit2.

Watch faces

You can change the type of watch to be displayed on the Watch screen.

Launch the **Galaxy Wearable** app on your mobile device, tap **Watch faces**, and then select a desired watch type. The watch face you selected will be applied on the Watch screen.

Appendix

Troubleshooting

Before contacting a Samsung Service Centre, please attempt the following solutions. Some situations may not apply to your Galaxy Fit2.

The Galaxy Fit2 screen does not turn on

When the battery is completely discharged, your Galaxy Fit2 will not turn on. Fully charge the battery before turning on the Galaxy Fit2.



The touchscreen responds slowly or improperly

- If you attach a screen protector or optional accessories to the touchscreen, the touchscreen may not function properly.
- If you are wearing gloves, if your hands are not clean while touching the touchscreen, or if you tap the screen with sharp objects or your fingertips, the touchscreen may malfunction.
- The touchscreen may malfunction in humid conditions or when exposed to water.
- Restart your Galaxy Fit2 to clear any temporary software bugs.
- Ensure that your Galaxy Fit2 software is updated to the latest version.
- If the screen is scratched or damaged, visit a Samsung Service Centre.

Your device freezes or encounters an error



Try the following solutions. If the problem is still not resolved, contact a Samsung Service Centre.

Forcing restart

If your Galaxy Fit2 is frozen and unresponsive, tap  →  on the quick panel to restart it.

Resetting the Galaxy Fit2

If the method above do not solve your problem, perform a factory data reset.

Tap  →  on the quick panel. Alternatively, launch the **Galaxy Wearable** app on your mobile device and tap **Home** → **About band** → **Reset band**. Before performing the factory data reset, remember to make backup copies of all important data stored in the Galaxy Fit2. Back up data from Galaxy Fit2 through the Galaxy Wearable app or Samsung cloud.

Another Bluetooth device cannot locate your Galaxy Fit2

- Reset your Galaxy Fit2 and try again.
- Ensure that your Galaxy Fit2 and the other Bluetooth device are within the Bluetooth connection range (10 m). The distance may vary depending on the environment the devices are used in.

If the tips above do not solve the problem, contact a Samsung Service Centre.

A Bluetooth connection is not established or your Galaxy Fit2 and the mobile device are disconnected

- Ensure that the Bluetooth feature on both devices is activated.
- Ensure there are no obstacles, such as walls or electrical equipment, between the devices.
- Ensure that the latest version of the Galaxy Wearable app is installed on the mobile device. If necessary, update the Galaxy Wearable app to the latest version.
- Ensure that your Galaxy Fit2 and the other Bluetooth device are within the Bluetooth connection range (10 m). The distance may vary depending on the environment the devices are used in.
- Restart both devices and launch the **Galaxy Wearable** app on the mobile device again.

The Galaxy Fit2 does not track your heart rate

- Wear the Galaxy Fit2 firmly around your lower arm just above the wrist.
- Launch the **Galaxy Wearable** app on your mobile device, tap **Home** → **Health settings** → **Auto heart rate settings**, and then select **Continuously** for how often to measure your heart rate.
- Select a watch face that includes heart rate information.

Calls are not connected

- Ensure that your Galaxy Fit2 is connected to a mobile device via Bluetooth.
- Ensure that you have not set call barring for the incoming phone number on the mobile device.
- Check if do not disturb mode or goodnight mode is activated. If one of these modes has been activated, the touchscreen does not turn on during incoming calls.

The battery does not charge properly (For Samsung-approved chargers)

- Ensure that you connect the Galaxy Fit2 to the charger and connect the dock to the charger properly.
- Visit a Samsung Service Centre and have the battery replaced.

The battery depletes faster than when first purchased

- When you expose the Galaxy Fit2 or the battery to very cold or very hot temperatures, the useful charge may be reduced.
- When using certain features, battery consumption will increase which can shorten the usage time.
- The battery is consumable and the useful charge will get shorter over time.

Your Galaxy Fit2 is hot to the touch

When using features that require more power or use your Galaxy Fit2 for an extended period of time, your Galaxy Fit2 may feel hot to the touch. This is normal and should not affect your Galaxy Fit2's lifespan or performance.

If the Galaxy Fit2 overheats or feels hot for a prolonged period, do not use it for a while. If the Galaxy Fit2 continues to overheat, contact a Samsung Service Centre.

Data stored in the Galaxy Fit2 has been lost

Always make backup copies of all important data stored in the Galaxy Fit2.

Otherwise, you cannot restore data if it is corrupted or lost. Back up data from Galaxy Fit2 through the Galaxy Wearable app or Samsung cloud. Samsung is not responsible for the loss of data stored in the Galaxy Fit2.

A small gap appears around the outside of the Galaxy Fit2 case

- This gap is a necessary manufacturing feature and some minor rocking or vibration of parts may occur.
- Over time, friction between parts may cause this gap to expand slightly.

Removing the battery

- **To remove the battery, contact an authorised service centre. To obtain battery removal instructions, please visit www.samsung.com/global/ecodesign_energy.**
- For your safety, you **must not attempt to remove** the battery. If the battery is not properly removed, it may lead to damage to the battery and device, cause personal injury, and/or result in the device being unsafe.
- Samsung does not accept liability for any damage or loss (whether in contract or tort, including negligence) which may arise from failure to precisely follow these warnings and instructions, other than death or personal injury caused by Samsung's negligence.

Copyright

Copyright © 2020 Samsung Electronics Co., Ltd.

This manual is protected under international copyright laws.

No part of this manual may be reproduced, distributed, translated, or transmitted in any form or by any means, electronic or mechanical, including photocopying, recording, or storing in any information storage and retrieval system.

Trademarks

- SAMSUNG and the SAMSUNG logo are registered trademarks of Samsung Electronics Co., Ltd.
- Bluetooth® is a registered trademark of Bluetooth SIG, Inc. worldwide.
- All other trademarks and copyrights are the property of their respective owners.