

Xbox One | PS4™ | PC



TURTLE BEACH®

# ELITE PRO

TACTICAL AUDIO CONTROLLER

## USER GUIDE



*Elite Pro Tactical Audio Controller for  
Xbox One, PS4™ and PC*



## Table of Contents

|   |     |
|---|-----|
| About the Elite Pro Tactical Audio Controller | P3  |
| Standard Setup                                | P5  |
| Xbox One Setup                                | P6  |
| PC Setup                                      | P7  |
| PS3™ Setup                                    | P8  |
| PS4™ Setup                                    | P9  |
| Controls & Features                           | P10 |
| Troubleshooting Tips                          | P16 |
| Regulatory Compliance Statements              | P17 |
| Warranty Information                          | P19 |

---

# ELITE PRO TACTICAL AUDIO CONTROLLER

**A**

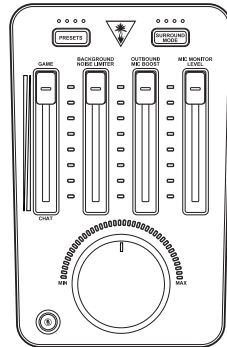

Tactical  
Audio Controller

**B**

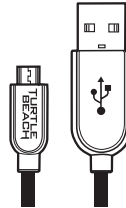

Power Cable (USB Mini)<sup>1</sup>

**C**

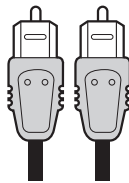

Digital Optical Cable

**D**

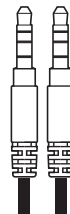

AUX / Stream / Xbox One Chat Cable

**E**

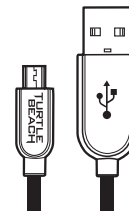

Programming  
Cable (USB Micro)<sup>2</sup>

<sup>1</sup> In order to comply with regulatory standards, the Power Cable used (USB Mini) cannot be longer than 3 meters.

<sup>2</sup> Always keep the Micro USB Port Cap installed when not in use.

**The Elite Pro T.A.C.** is the most powerful audio controller designed for e-sports, combining cutting-edge audio technology like *DTS™* Headphone:X 7.1 Surround Sound and *Superhuman Hearing™* with Turtle Beach's incredibly powerful chat and microphone tuning tools, giving eSports athletes everything they need to win.

---

**Video demonstrations at**  
[turtlebeach.com/tac](https://turtlebeach.com/tac)

**Any questions?**  
[turtlebeach.com/support](https://turtlebeach.com/support)

Go to Table of Contents 

# About the Tactical Audio Controller

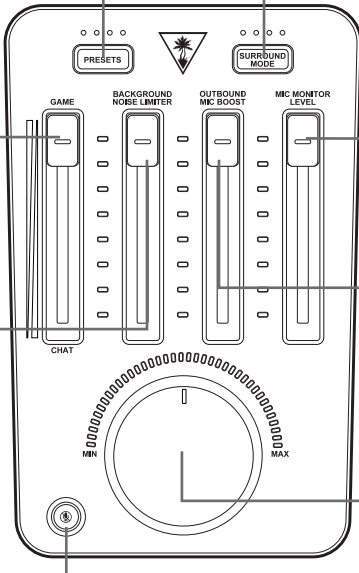

**Presets:**  
Adjust the sound of your game audio with Turtle Beach Signature Audio presets

**Surround Mode:**  
Adjust your virtual surroundings with DTS Headphone:X 7.1 Surround Sound modes

**Game/Chat Balance:**  
Set the perfect balance of Game and Chat Audio so that you can hear your teammates while focusing on the game. Move this fader to the top to only hear Game Audio. Move it to the bottom for only Chat.

**Background Noise Limiter:**  
Turn this up so that your teammates don't have to listen to your roommate vacuuming. The higher the setting the less ambient noise your mic will pick up. Make sure to test out this setting and calibrate it to your environment.\*

**Mic Mute:**  
Press to mute your outgoing Mic. A LED will glow red to indicate no one can hear you. The Mic Mute LED in the bottom left corner of the TAC indicates whether others can hear you. While speaking the Mic Mute LED should glow Blue. If it is not, turn down the Background Noise Limiter.

**Mic Monitor Level:**  
Adjust how loud your voice plays in the headset so that you don't end up yelling. Doesn't effect your voice level to others.

**Outbound Mic Boost:**  
Tweak this to adjust the level at which others hear you. This setting will be dependent on which Elite Pro Microphone and console you are playing with.

**Master Volume:**  
Control the level of everything playing through your headset. Press to Mute all paths, both incoming and outgoing. This means you won't hear the game & chat, and that no-one will hear you, an emergency stop of sorts.

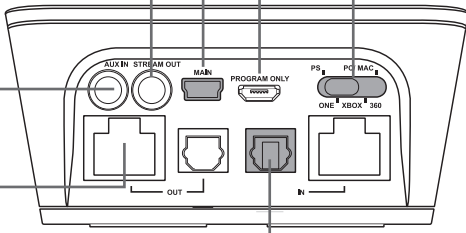

**Main:**  
Your primary USB port, this should always be connected to power your device and pass audio on some platforms.

**Program Only:**  
This is used to update your unit when new firmware/presets become available. Download the Ear Force Audio Hub at [turtlebeach.com/elitepro](http://turtlebeach.com/elitepro)

**Stream Out:**  
Output your game Game/Chat/Mic audio to your PC/Mac for recording/streaming. This will output audio to the exact levels you have adjusted it for listening in your headset, excluding mic monitor. The volume of your voice will be based upon the Outbound Mic Boost.

**Mode Switch:**  
Always make sure you're set to the right mode!  
This is important for optimal performance.

**Aux In:**  
Mix in music from your Phone or Tablet. Or use for phone calls with your smartphone.

**Local Chat In/Out:**  
Connections for Tournament Chat

**Digital Optical In/Out:**  
Connections for your Console Game audio. Use the Digital Optical Out to pass audio straight through to another device.

\*The mic mute LED will light up blue when the microphone detects noise and it will be white when it doesn't.

You can use this to properly adjust the "Background Noise Limiter" on the TAC. Increase the noise limiter one notch at a time until the flashing blue stops. Once it does, that means your microphone is no longer picking up background sounds, such as your keyboard, breath, etc.

Do make sure however that you don't raise it too far and it still lights up blue when you speak.

# Elite Pro Tactical Audio Controller

## Standard Headset Setup

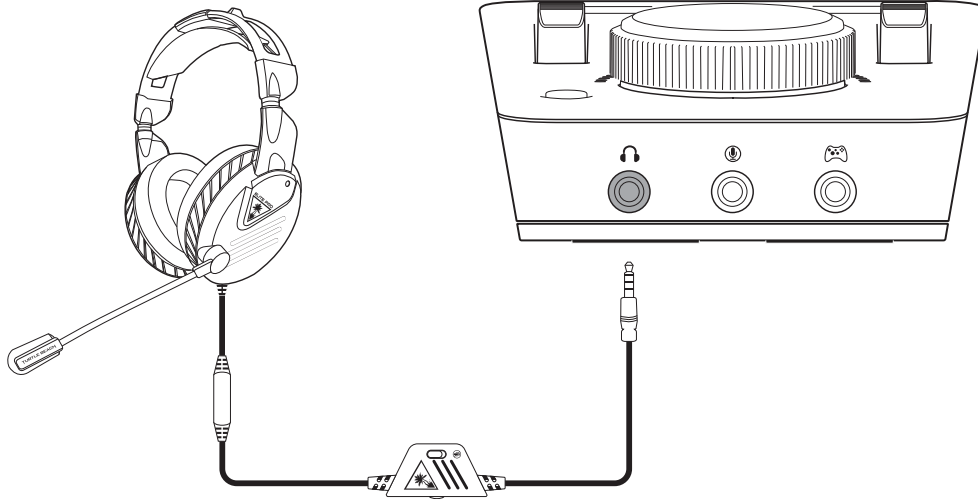

## Tournament Noise Cancelling Mic Setup

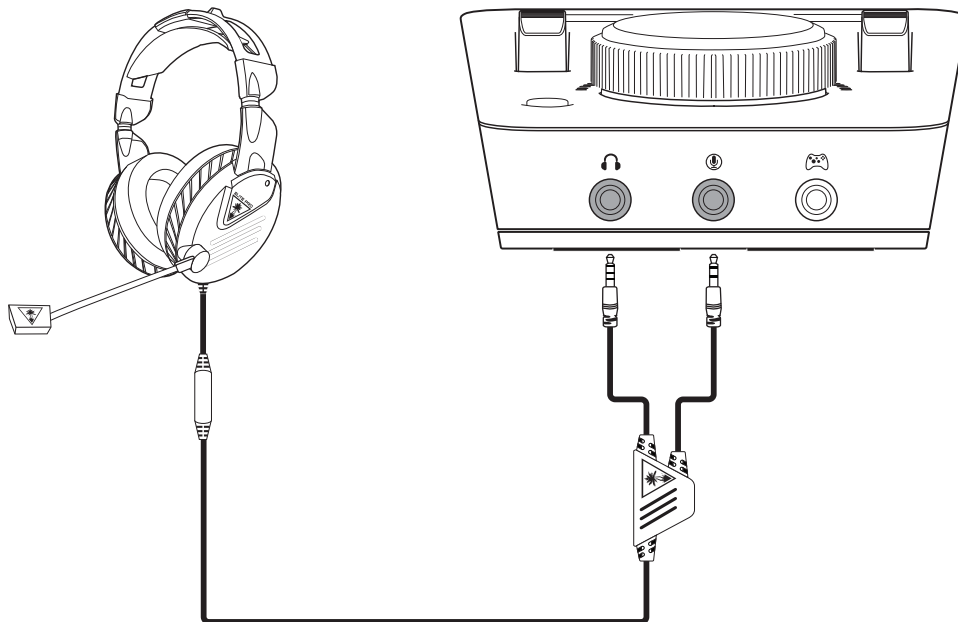

**Note:** Tournament Noise Cancelling Microphone sold separately. The Tournament Noise Cancelling Microphone can only be used with the Tactical Audio Controller. Calibration of the background noise limiter is especially important when using the Noise Cancelling Microphone. See bottom of the previous page for calibration instructions.

# Elite Pro Tactical Audio Controller

## Xbox One Setup

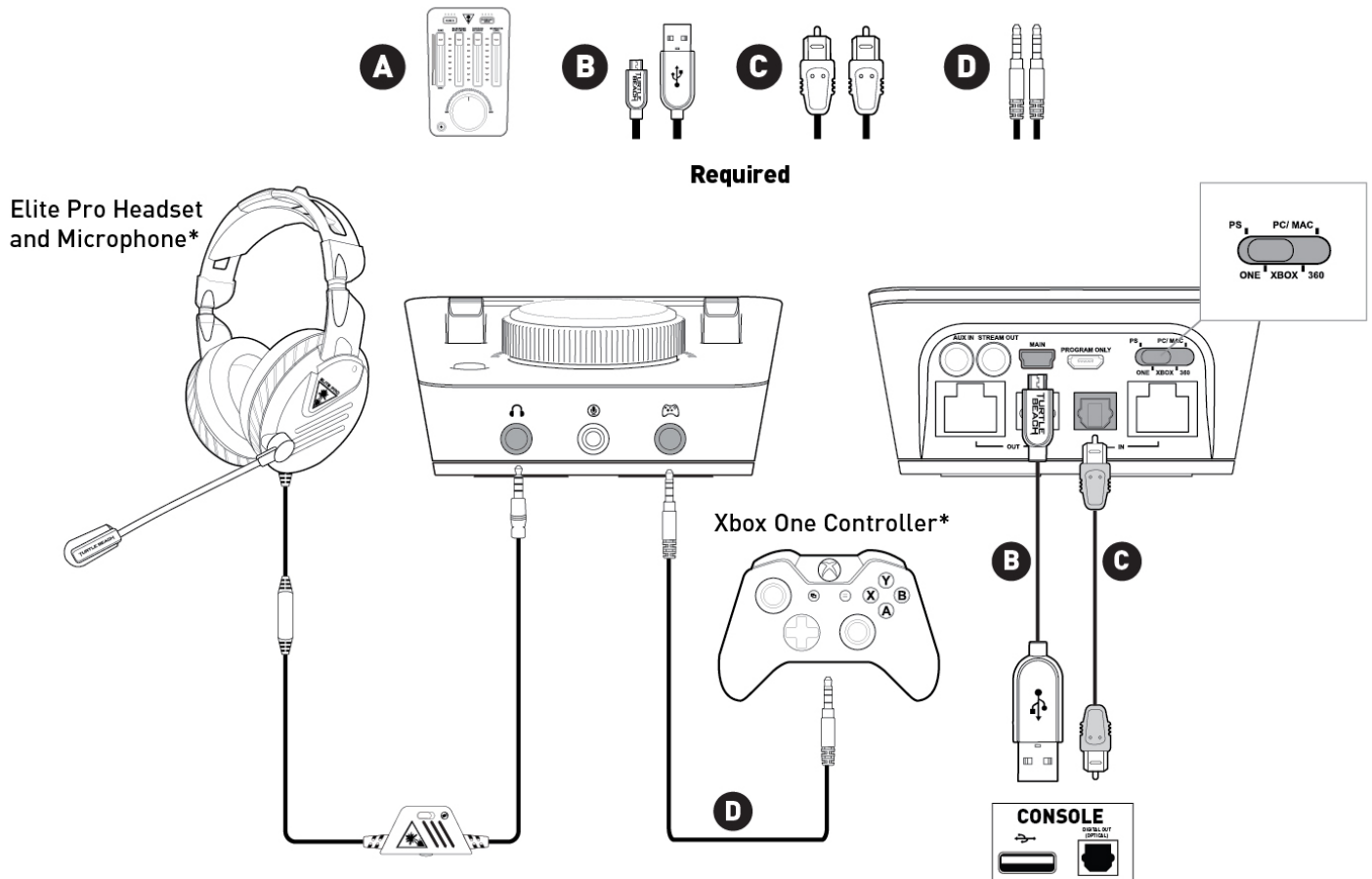

Compatible out-of-the-box with the new Xbox One Controller with 3.5mm jack. Other Xbox One Controllers require a Elite Pro Tactical Audio Adapter\*

*\*Sold Separately*

1. Go to Settings >> All Settings >> Display & Sound >> Audio Output
  - a. Select Optical Audio >> Bitstream Out
  - b. Select Bitstream Format >> Dolby Digital

### **Xbox One Controller with Tactical Audio Adapter**

- a. Turn the game volume all the way using the left side of the adapter
- b. Turn the chat volume all the way up using the right side of the adapter
- c. Long press the mic mute button until you hear only one tone to indicate mic monitoring is off

### **Xbox One Controller with Headset Audio Controller**

- a. Balance the game/chat mixer to chat only by pressing down on the left side of the adapter until you hear a tone
- b. Press up on the right side until you hear a tone to set the volume to max
- c. Long-press the mic mute button until you hear only one tone to indicate mic monitoring is off

### **Xbox One Controller with Microsoft Stereo Headset Adapter**

- a. Balance the game/chat mixer to chat only by pressing the person icon on the left side of the adapter until you hear a tone
- b. Press the plus button on the right side of the adapter until you hear a tone to set the volume to max

# Elite Pro Tactical Audio Controller

## PC Setup

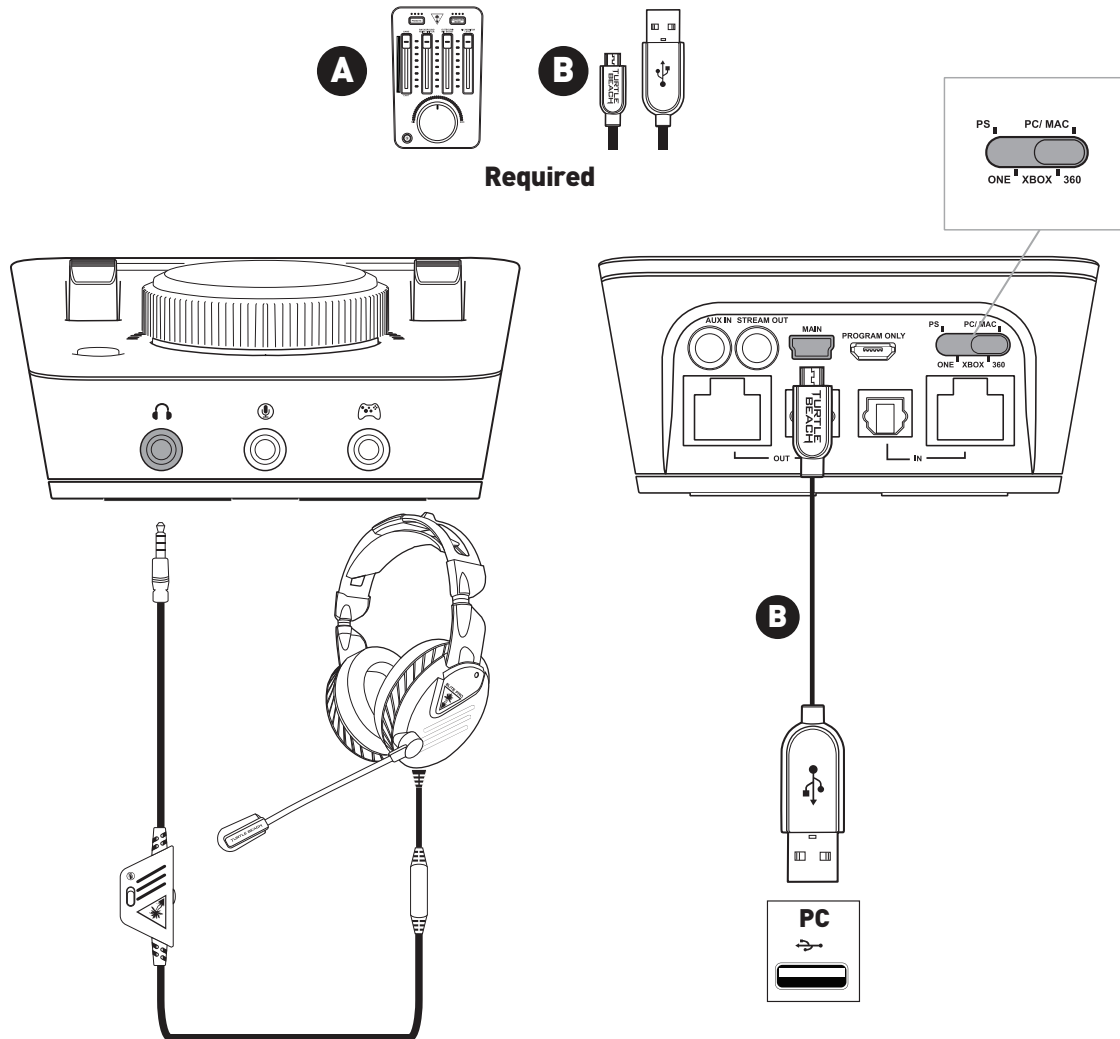

1. Right-click the Speaker icon in the Taskbar, then click "Playback Devices".
  - a. Right-click "Turtle Beach ELITE GAME" and click "Set as Default Device".
  - b. Right-click "Turtle Beach ELITE GAME", click "Configure Speakers", and select 7.1 Surround Sound.
  - c. Right-click "Turtle Beach ELITE CHAT", and click "Set as Default Communication Device".
  - d. Click the Recording Tab, then right-click "Turtle Beach ELITE CHAT" and click "Set as Default Device".

**Note:** If you are only being presented with an option for Turtle Beach Elite Chat in your playback devices then double check that the mode switch is set to PC/Mac and not PS.

# Elite Pro Tactical Audio Controller

## PS3™ Setup

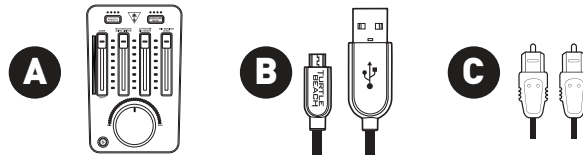

Required

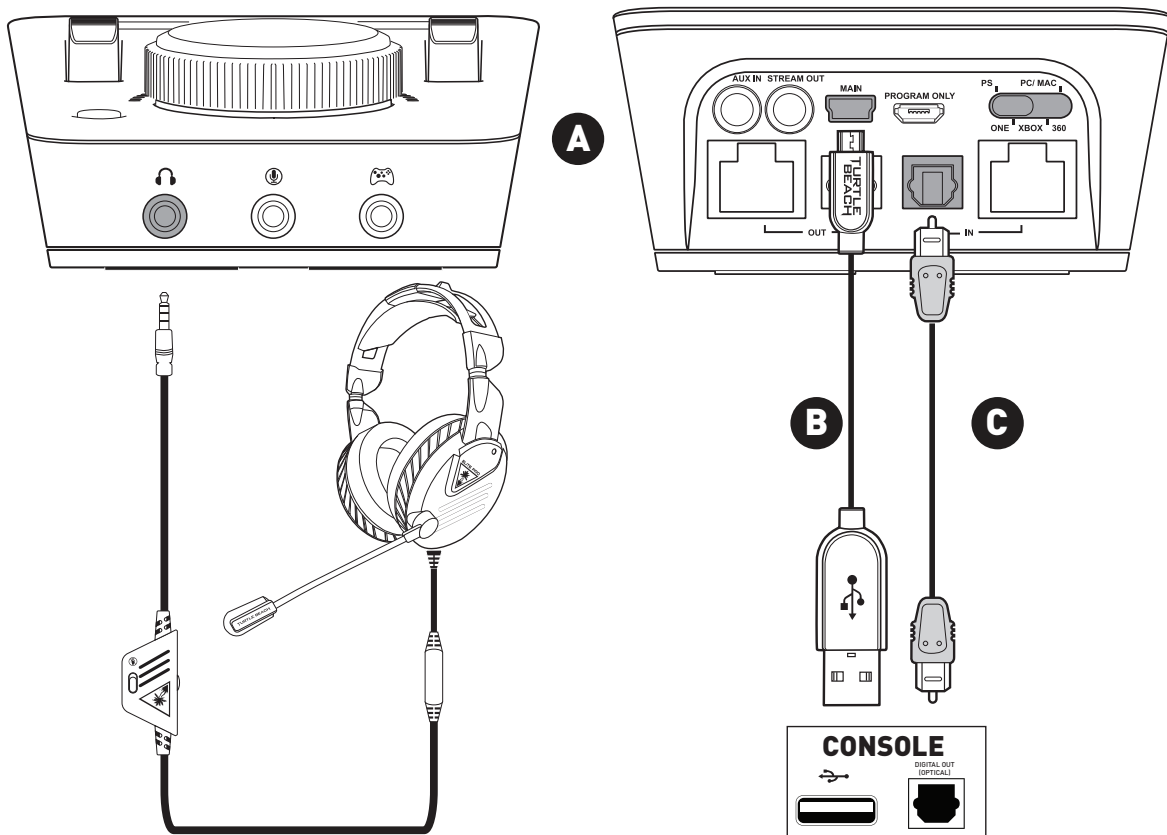

1. Go to Settings >> Accessory Settings >> Audio Device Settings
  - a. Select Turtle Beach ELITE CHAT for both Input Device & Output Device.
2. Go to Settings >> Sound Settings >> Audio Output Settings
  - a. Select Optical Digital
  - b. Select ONLY Dolby Digital 5.1 Ch.
  - c. Set Audio Multi Output to On.



# Elite Pro Tactical Audio Controller

## PS4™ Setup

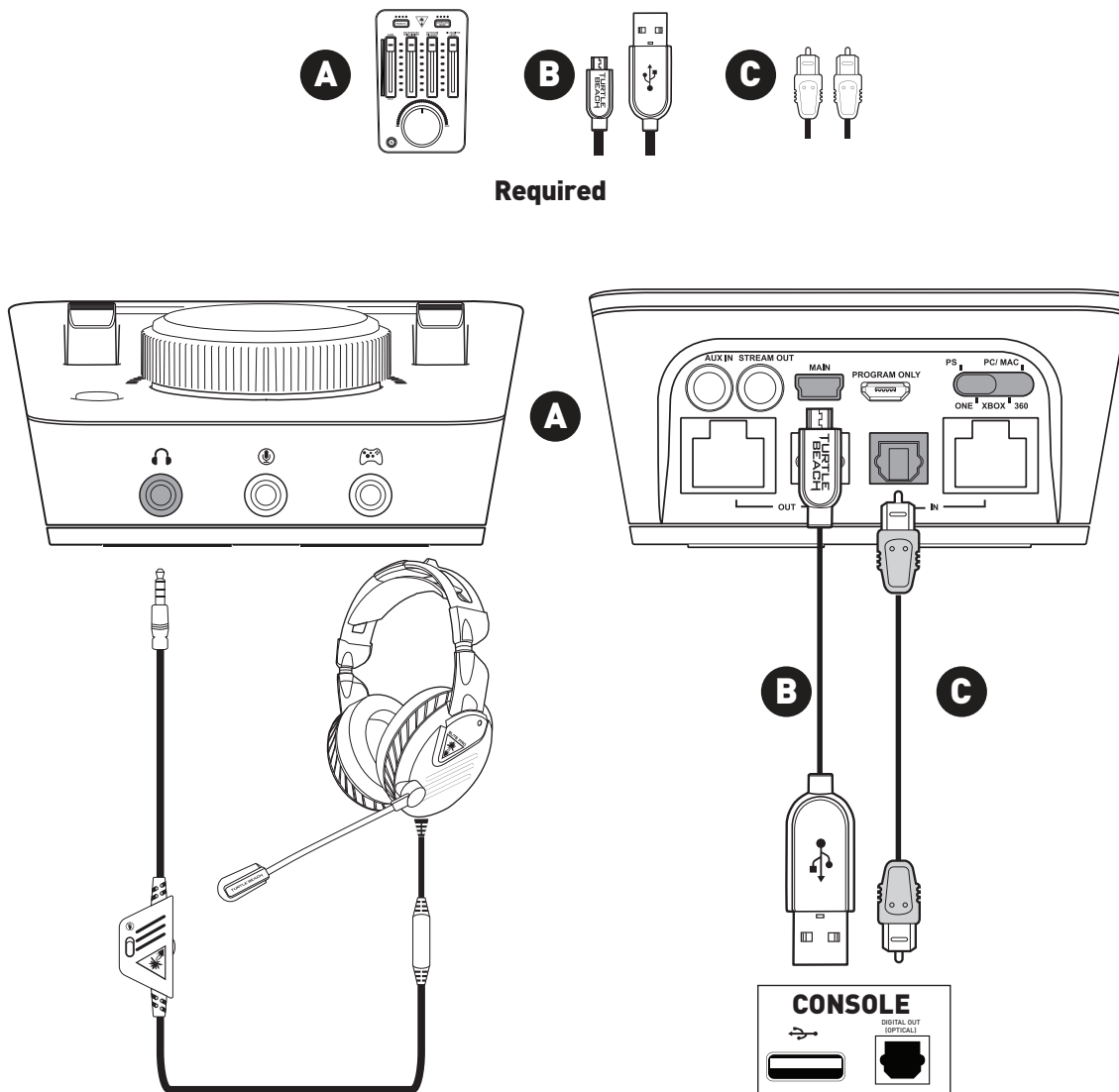

1. Go to Settings » Sound and Screen » Audio Output Settings
  - a. Select Primary Output Port » Digital Out (OPTICAL) » **ONLY** Dolby Digital 5.1ch.
  - b. Select Audio Format (Priority) » Bitstream (Dolby)
2. Go to Settings » Devices » Audio Devices
  - a. Select USB Headset (Turtle Beach ELITE CHAT) for Input & Output Device
  - b. Set Output to Headphones to Chat Audio
  - c. Set Volume Control (Headphones) level to maximum

**Note:** If your volume feels quiet or is dropping out, double check that your mode switch is set to PS and you have "Output to Headphones" set to Chat Audio. If this was set to 'All Audio' you would be sending both your game and chat sound over the TAC's USB path rather than the game sound coming separately over the optical cable.



# Elite Pro Tactical Audio Controller Product Features







DTS® Headphone:X 7.1 Surround Sound is an innovative new technology that uses sophisticated processing to create immersive sound using just two speakers, making it feel like you're in the center of your own universe with high quality sounds all around and above you. Designed to work with almost any headset, it significantly enhances your audio experience whether you're gaming, listening to music or watching movies.

Working with Turtle Beach to further enhance this technology, DTS has created Surround Sound Modes to reproduce the sonic characteristics of rooms optimized for specific types of content. For each of the DTS® Headphone:X Surround Sound modes, Turtle Beach has designed four genre-based presets that optimize the sound for specific types of games, music and movies.

# DTS Headphone:X Surround Modes & Audio Presets

|  <span>● ○ ○ ○   GAME MODE </span> |  |
|--|--|
| <b>Signature Sound</b>   | Turtle Beach's SIGNATURE SOUND: place yourself in the middle of the action and hear your games just as the developers intended.                          |
| <b>Shooter</b>   | Enter the warzone fully armed: feel your gun's recoil hit your chest, experience the full force of explosions as you lead your squad to victory.         |
| <b>Superhuman Hearing</b>  | Gain the ultimate audio advantage. Amplify low and faint sounds to hear everything, pinpoint your enemies and defeat them before they know you're there. |
| <b>Footstep Focus</b>  | Focus on the sound of enemy footsteps approaching, hear every detail and gain a true audio advantage.  |

|  <span>● ● ○ ○   MOVIE MODE </span> |   |
|---|---|
| <b>Signature Sound</b>  | Turtle Beach's SIGNATURE SOUND: get the best seat in the house and experience your movies like never before.                |
| <b>Action</b>   | Be the hero, face the explosions, duck the gunfire and hear the evac chopper circling overhead as you save the world again. |
| <b>Horror</b>   | Build the suspense, hear every creaking footstep and bone-rattling scream... just try to get out alive.                     |
| <b>Drama</b>  | Intensify the story and bring characters to life with pinpoint vocals and enhanced dialog.                                  |

|  <span>● ● ● ○   MUSIC MODE </span> |   |
|---|---|
| <b>Signature Sound</b>  | Turtle Beach's SIGNATURE SOUND: bring your music onto a personal stage and scan your ticket to your own private concert experience. |
| <b>Stadium</b>  | Experience live concert music as it was meant to be heard, feel the crowd around you as the band on stage turns it up to 11.        |
| <b>Acoustic</b>   | Step into an acoustic open-mic night and experience a personal concert for one, just you and your favorite artist.                  |
| <b>Dance</b>  | Put your hands in the air and place yourself in the middle of a nightclub as the DJ drops your favorite dance track.                |

| <span>● ● ● ●   SURROUND OFF </span> |  |
|---|--|
| <b>Natural Sound</b>  | Turtle Beach tuned Natural Sound, hear your media just as the creators intended.                                   |
| <b>Bass Booster</b>   | Turn up the bass: feel the deep sound effects in your games and the punch of bass heavy music tracks.              |
| <b>Bass &amp; Treble Booster</b>  | Turn everything up: increased lows and highs give you more of everything for a more powerful audio experience.     |
| <b>Vocal Booster</b>  | Tune in to the vocals on music tracks and dialog in games and movies, make your characters and stories come alive. |

# Digital Optical Pass-Through

## Digital Optical Pass-Through

Integrating the TAC with your Audio Receiver/Home Entertainment system is easy to do. The TAC can pass-through audio to the system you already have in place. Just connect your existing Digital Optical Cable to the TAC and use the included Digital Optical Cable to finish the circuit. Now if you want to play a game or watch a movie with friends there are no adjustments needed!

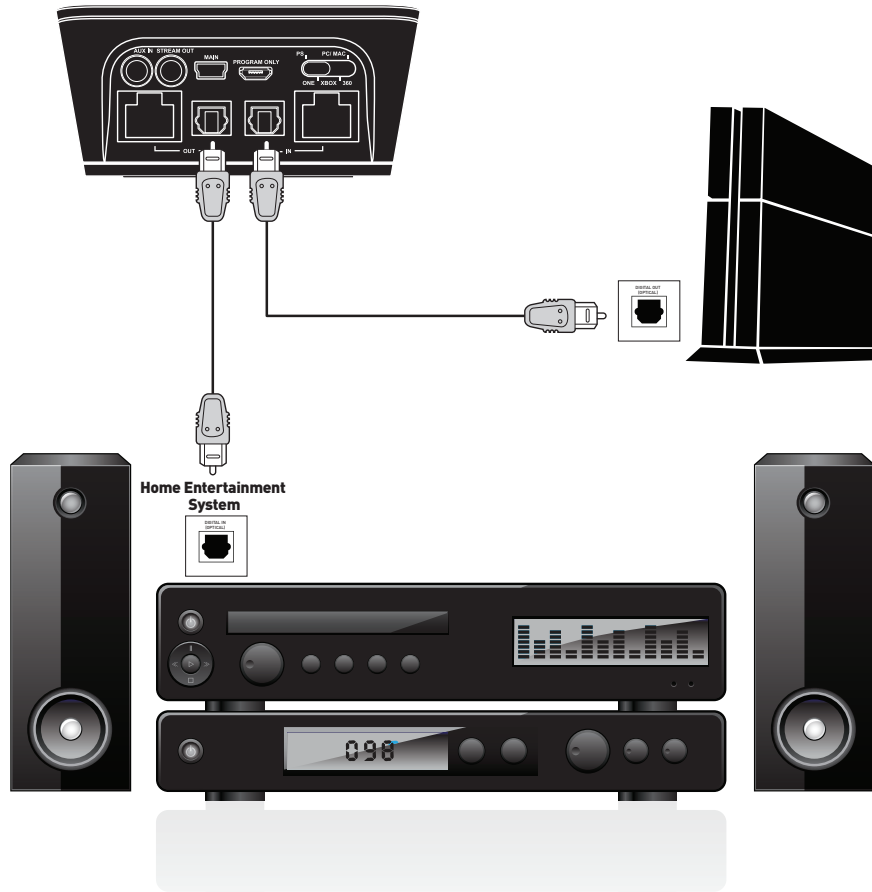

Playing some couch co-op? Use the Digital Optical Pass-Through to share the same DTS Headphone:X 7.1 Surround Sound to a second TAC unit.\*

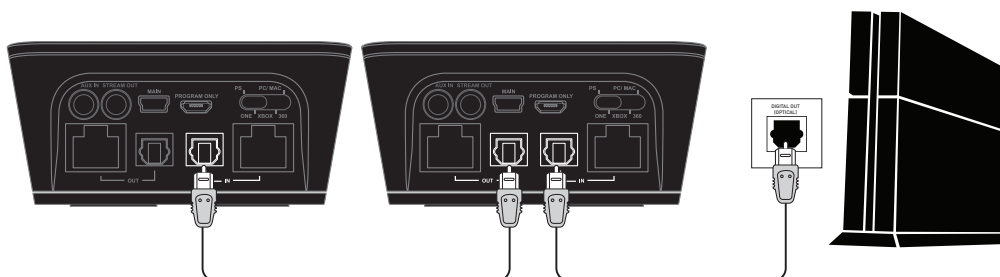

\*Additional Optical Cable may be required

# Auxiliary In

## Auxiliary In

When repetitive Game Audio just isn't cutting it, connect to a phone or tablet to listen to your favorite music through the TAC. The Aux In port will pass all audio through at full volume so make sure to control the level of your music from your mobile device or from the phone or tablet.

Additionally, you can also make/answer phone-calls using this same exact setup so there's no need to step away from your game.

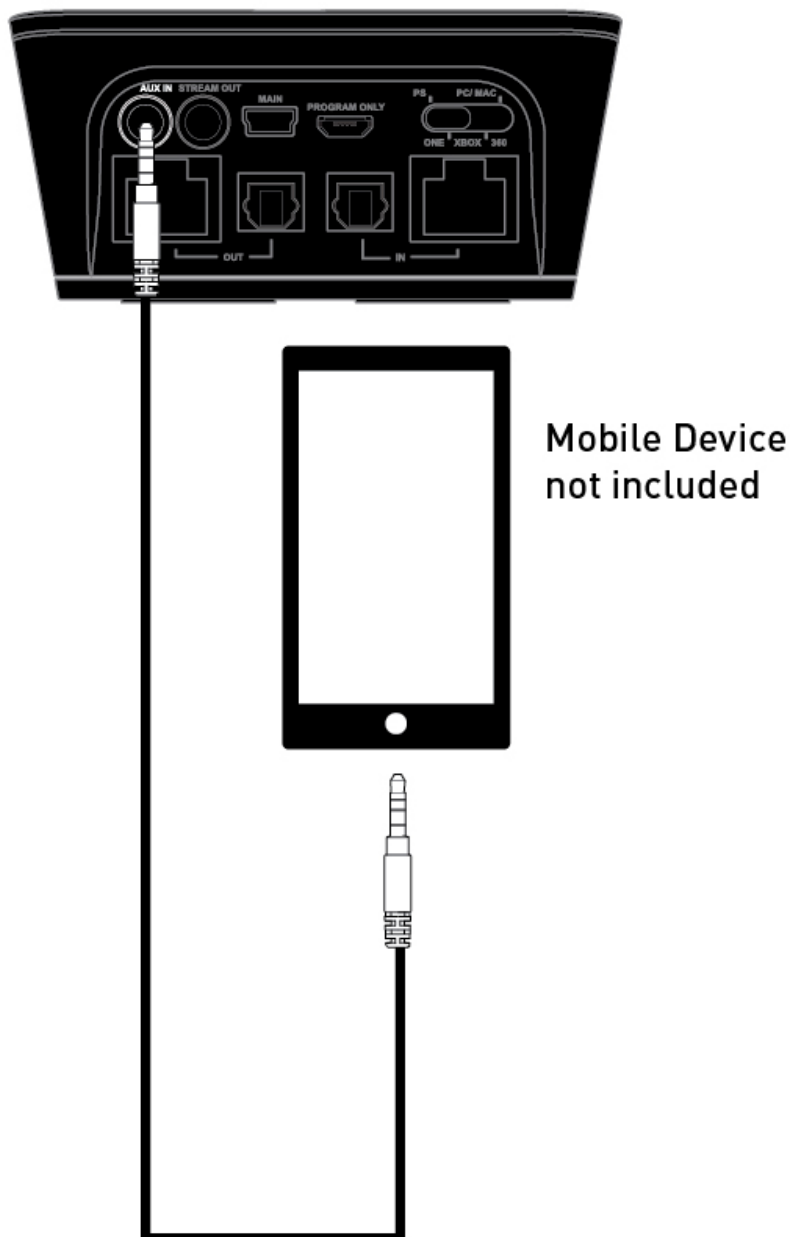

# Local Chat and Streaming

## Local Tournament Setup

It can be frustrating dealing with chat lag and the limitations of on-line chat when setting up a local tournament. The TAC has you covered, connect however many TACs together as you need for lag-free high-quality chat. No limitation to this setup and the best part is all you need to daisy-chain the units together is a standard Ethernet cable\*. No need for proprietary cables, connect the cable and you're locked in and ready for a tournament.

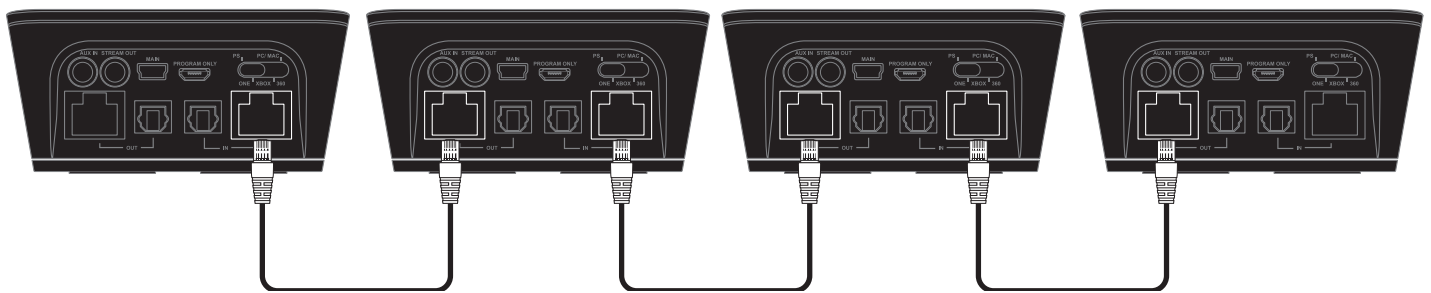

\*Ethernet cables sold separately

## Audio Stream Out

Want to live stream your gaming and become an Internet celebrity? Use the Stream Output to pass your Game, Chat, Mic, and Auxiliary Audio at full volume to the Line In on your PC/Mac for recording/streaming. When set-up in Local Tournament Chat Mode the voices of your teammates will be included in the Stream Output as well. The Stream Out will output audio exactly the same as you tuned the audio to be heard in your headset excluding Mic Monitor. It will output your mic volume to same level you have it tuned for other players to hear.

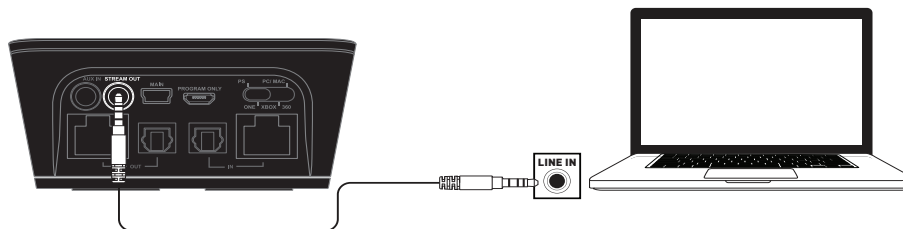

**Note:** This feature is designed for use when on Console. When gaming on PC/Mac<sup>®</sup> and streaming from the same system we recommend that audio is managed through PC Software such as OBS. The Stream Out on the TAC does not need to be used.

## Tactical Audio Controller Programmability

The TAC uses advanced Multipoint Control Unit (MCU) and Digital Signal Processor (DSP) firmware. From time to time Turtle Beach will release new updates to improve your user experience and even add new features.

If you have any suggestions for improvements or new presets please let us know!

Customize your audio presets and always make sure your TAC is running on the latest firmware.

Visit  
**TURTLEBEACH.COM/TAC**  
and download the Ear Force Audio Hub



To contact our support team visit  
**TURTLEBEACH.COM/SUPPORT**

# Troubleshooting Tips

## Elite Pro Tactical Audio Controller

| Issue                  | Solution  |
|------------------------|---|
| People cannot hear me  | <ol style="list-style-type: none"><li>1. Make sure the "Background Noise-Limiter" Fader is NOT at the max setting. This Fader should be in the lower-half when used in a home environment.</li><li>2. Make sure the Console switch on the back of the TAC is set to the platform you are gaming on.</li><li>3. Check that the Mic is not muted on the TAC. The Mic LED (Bottom left Corner of the TAC) should indicate as follows:<ul style="list-style-type: none"><li>-Red = Muted</li><li>-White = Unmuted (Noise Gate Closed)</li><li>-Blue = Unmuted (Noise Gate Open)</li></ul></li><li>4. Make sure microphone is not muted on the in-line controls (if using the original cable).</li></ol> |
| I cannot hear the game | <ol style="list-style-type: none"><li>1. Make sure your Game/Chat Balance Fader is NOT set all the way to Chat Audio.</li><li>2. Make sure the Console switch on the back of the TAC is set to the platform you are gaming on.</li><li>3. If on Console, check that the Digital Optical Cable is connected to the "IN" port and not the "OUT" port on the TAC.</li><li>4. If on Console, make sure you have removed the plastic protective tips from both ends of the optical cable and that it's firmly connected to both the console and TAC.</li><li>5. If on PC, make sure to set TAC as your default device in Windows and in the particular game you are playing.</li></ol>                   |

If your issue is not resolved by these steps, please visit:  
[turtlebeach.com/elitepro](https://turtlebeach.com/elitepro) or [turtlebeach.com/support](https://turtlebeach.com/support)



# Regulatory Compliance Statements for the Turtle Beach Elite Pro Tactical Audio Controller Model (Elite Pro T.A.C)

## Federal Communications Commission (FCC) Compliance Notices

### Class B Interference Statement

This equipment has been tested and found to comply with the limits for a Class B digital device, pursuant to Part 15, Subpart B of the FCC Rules. These limits are designed to provide reasonable protection against harmful interference in a residential installation. This equipment generates, uses, and can radiate radio frequency energy and, if not installed and used in accordance with the instructions, may cause harmful interference to radio communications. However, there is no guarantee that interference will not occur in a particular installation. If this equipment does cause harmful interference to radio or television reception, which can be determined by turning the equipment off and on, the user is encouraged to try to correct the interference by one or more of the following measures:

- Reorient or relocate the receiving antenna.
- Increase the separation between the equipment and receiver.
- Connect the equipment into an outlet on a circuit different from that to which the receiver is connected.
- Consult the dealer or an experienced radio/TV technician for help.

### FCC Caution:

This device complies with Part 15 of the FCC Rules. Operation is subject to the following two conditions: (1) This device may not cause harmful interference, and (2) this device must accept any interference received, including interference that may cause undesired operation.

### Canadian ICES Statements

#### Canadian Department of Communications Radio Interference Regulations

This digital apparatus does not exceed the Class B limits for radio-noise emissions from a digital apparatus as set out in the Radio Interference Regulations of the Canadian Department of Communications. This Class B digital apparatus complies with Canadian ICES-003.

#### Règlement sur le brouillage radioélectrique du ministère des Communications

Cet appareil numérique respecte les limites de bruits radioélectriques visant les appareils numériques de classe B prescrites dans le Règlement sur le brouillage radioélectrique du ministère des Communications du Canada. Cet appareil numérique de la Classe B est conforme à la norme NMB-003 du Canada.

# European Union and European Fair Trade Association (EFTA) Regulatory Compliance Declaration of Conformity

Marking by this symbol:



Indicates compliance with the Essential Requirements of the EMC Directive of the European Union (2004/108/EC). This equipment meets the following conformance standards:

**Safety:** EN 60950-1: 2006 + A11: 2009 + A1: 2010 + A12: 2011 (T-Mark License).  
IEC 60950-1: 2005 (2nd Edition) + Am 1: 2009 (CB Scheme Report/Certificate),  
EN 50332-1: 2000, EN50332-2: 2003, EN 71-3: 2013.

Also Licensed for Standards:

UL 60950-1: 2007 R12.11, CAN/CSA-C22.2 No. 60950-1-07 + A1: 2011

Additional licenses issued for specific countries available on request

**Emissions:** EN 55022: 2010, CISPR 22: 2008

**Immunity:** EN 55024: 2010, CISPR 24: 2010  
EN 61000-4-2: (2009), EN 61000-4-3: (2010), EN 61000-4-8: (2010)

The products are licensed, as required, for additional country specific standards for the International Marketplace. Additional issued licenses available upon request.

**Environmental:** Low Voltage Directive 2006/95/EC, RoHS 2011/65/EU,  
REACH 2006/1907/EC, WEEE 2012/19/EU, Packaging 94/62/EC,  
Toys Safety Directive 2009/48/EC

## Warning!

This is a Class B product. In a domestic environment, this product may cause radio interference, in which case, the user may be required to take appropriate measures.

## Achtung!

Dieses ist ein Gerät der Funkstörgrenzwertklasse B. In Wohnbereichen können bei Betrieb dieses Gerätes Rundfunkstörungen auftreten, in welchen Fällen der Benutzer für entsprechende Gegenmaßnahmen verantwortlich ist.

## Attention!

Ceci est un produit de Classe B. Dans un environnement domestique, ce produit risque de créer des interférences radioélectriques, il appartiendra alors à l'utilisateur de prendre les mesures spécifiques appropriées.



This symbol on the product or its packaging indicates that this product must not be disposed of with your other household waste. Instead, it is your responsibility to dispose of your waste equipment by handing it over to a designated collection point for the recycling of waste electrical and electronic equipment. The separate collection and recycling of your waste equipment at the time of disposal will help conserve natural resources and ensure that it is recycled in a manner that protects human health and the environment. For more information about where you can drop off your waste for recycling, please contact your local authority, or where you purchased your product.

Please visit the following URL for a complete copy of the declaration of conformity:

<http://www.turtlebeach.com/homologation>

# LIMITED ONE YEAR WARRANTY FOR TURTLE BEACH PRODUCTS:

Voyetra Turtle Beach, Inc. ("VTB") warrants to the original end-user purchaser ("Purchaser") that the retail Turtle Beach hardware product herein ("Product") will be free of defects in materials and workmanship for a period of one year from the date of purchase by the Purchaser ("Warranty Period"). Any Extended Warranty or Service Plans purchased through a Retail store are not honored by VTB. The Warranty refers to the repair/replacement of a defective product during this period and not a refund.

This limited warranty is extended only to the original Purchaser of a new product, which was not sold "AS IS". It is not transferable or assignable to any subsequent purchaser. This limited warranty is applicable only in the country or territory where the Product was purchased from an authorized VTB retailer and does not apply to a Product that has been purchased as used or refurbished or was included as part of a non-VTB product.

## WARRANTY SERVICE:

In the USA and CANADA Warranty Service is provided by our Turtle Beach USA offices and in all other Countries it is provided by our local International Distributors when available. Refurbished/Recertified products are sold on an AS IS basis with a 90-day Warranty or less in accordance with each vendor's policy.

VTB does not warrant uninterrupted or error-free operation of the Product and is under no obligation to support the Product for all computer operating systems or future versions of such operating systems.

If a defect should occur during the Warranty Period, Purchaser must contact VTB to obtain a Return Merchandise Authorization ("RMA") number on the basis of the dated purchase receipt. Purchaser will be responsible for shipping costs incurred in returning the defective Product to an authorized VTB service center, or to the repair facility located at VTB's corporate headquarters. VTB will not be responsible for other products or accessories included with the defective Product sent to VTB. The RMA number must be clearly indicated on the outside of the package. Packages without an RMA number will be refused by VTB or its representatives and returned to sender at the sender's expense.

In the event of a defect, Purchaser's sole and exclusive remedy, and VTB's sole liability, is expressly limited to the correction of the defect by adjustment, repair, or replacement of the Product at VTB's sole option and expense. VTB owns all Products it has replaced and all parts removed from repaired Products. VTB uses new and reconditioned parts made by various manufacturers in performing warranty repairs and building replacement products. If VTB repairs or replaces a product, the original Warranty Period is not extended, however, VTB warrants that repaired or replacement parts will be free from defects in material and workmanship for a period of thirty (30) days from the date of repair or replacement, or for the remainder of the Warranty Period, whichever is greater.

This warranty does not apply to any Product that has had its serial number altered, removed or defaced, or any Product damage caused by shipping, improper storage, accident, problems with electrical power, abuse, misuse, neglect, ordinary wear, acts of God (e.g. flood), failure to follow directions, improper maintenance, use not in accordance with product instructions, unauthorized modification or service of the Product or damage resulting from the use of the Product with hardware, software or other products not provided by or specifically recommended by VTB.

## NOTES:

- Replacement Parts and accessories that are subject to "wear and tear" such as earpads, mic foam covers, talkback cables, etc. have a three (3) month Warranty.
- Replacement Parts for Discontinued Products are sold on an AS IS basis, they are not supported and come with a 30 day Warranty.

THIS LIMITED WARRANTY IS PURCHASER'S SOLE AND EXCLUSIVE REMEDY AND IS IN LIEU OF ALL OTHER WARRANTIES, EXPRESS OR IMPLIED. TO THE EXTENT PERMITTED BY APPLICABLE LAW, VTB HEREBY DISCLAIMS THE APPLICABILITY OF ANY IMPLIED WARRANTY OF MERCHANTABILITY, FITNESS FOR A PARTICULAR PURPOSE OR USE FOR THE PRODUCT. IF SUCH A DISCLAIMER IS PROHIBITED BY APPLICABLE LAW, THE IMPLIED WARRANTY IS LIMITED TO THE DURATION OF THE FOREGOING LIMITED WRITTEN WARRANTY.

IN NO EVENT SHALL VTB BE LIABLE FOR ANY INDIRECT, INCIDENTAL, SPECIAL, PUNITIVE OR CONSEQUENTIAL DAMAGES, OR DAMAGES, INCLUDING BUT NOT LIMITED TO ANY LOST PROFITS, DATA, OR LOSS OF USE, ANY THIRD PARTY CLAIMS, AND ANY INJURY TO PROPERTY OR BODILY INJURY (INCLUDING DEATH) TO ANY PERSON, ARISING FROM OR RELATING TO THE USE OF THIS PRODUCT OR ARISING FROM BREACH OF THE WARRANTY, BREACH OF CONTRACT, NEGLIGENCE, TORT, OR STRICT LIABILITY, EVEN IF VTB HAS BEEN ADVISED OF THE POSSIBILITY OF SUCH DAMAGES.

This warranty supersedes all prior agreements or understandings, oral or written, relating to the Product, and no representation, promise or condition not contained herein will modify these terms. Some states do not allow the exclusion or limitation of incidental or consequential damages, so the above exclusion or limitation may not apply to you. This warranty gives you specific legal rights. You may also have other rights, which vary from state to state. Any action or lawsuit for breach of warranty must be commenced within eighteen (18) months following the purchase of the Product.

# EXCLUSIONS FROM LIMITED WARRANTY:

This Limited Warranty shall not apply and VTB has no liability under this Limited Warranty if the Turtle Beach Product:

- is used for commercial purposes such as "LAN, Call Centers" (including rental or lease);
- is modified or tampered with;
- is damaged by Acts of God, power surge, misuse, abuse, negligence, accident, wear and tear, mishandling, misapplication, or other causes unrelated to defective materials or workmanship;
- serial number is defaced, altered or removed;
- is not used in accordance with the documentation and use instructions; or
- is repaired, modified or altered by other than authorized repair centers.
- is no longer available because it was discarded.



For PS4™ | Xbox One |  
PC



[youtube.com/TurtleBeachVideos](https://youtube.com/TurtleBeachVideos)



Product support and warranty information:  
[support.turtlebeach.com](https://support.turtlebeach.com)