

Panasonic®

Operating Instructions Functional Manual

FULL HD LCD Display For business use

Model No.	TH-55AF1U	55-inch model
	TH-49AF1U	49-inch model
	TH-42AF1U	42-inch model
	TH-55AF1W	55-inch model
	TH-49AF1W	49-inch model
	TH-42AF1W	42-inch model

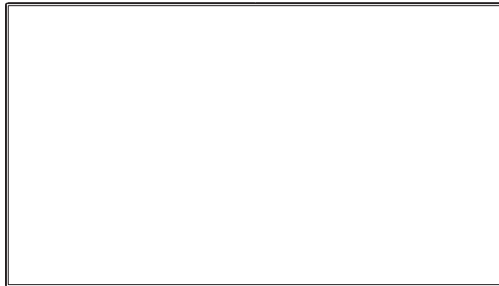

* This manual is common to all the models regardless of suffixes of the model number.

U : for US, Canada and Mexico

W : for EU, CIS, South East Asia and Middle East Asia

English

Please read these instructions before operating your set and retain them for future reference.

HDMI

DPQP1005ZA/X1

Dear Panasonic Customer

Welcome to the Panasonic family of customers. We hope that you will have many years of enjoyment from your new LCD Display.

To obtain maximum benefit from your set, please read these Instructions before making any adjustments, and retain them for future reference.

Retain your purchase receipt also, and note down the model number and serial number of your set in the space provided on the rear cover of these instructions.

Visit our Panasonic Web Site <http://panasonic.com>

Table of Contents

Before use

- Illustrations and screens in this Operating Instructions are images for illustration purposes, and may be different from the actual ones.
- Descriptive illustrations in this Operating Instructions are created mainly based on the 55-inch model.

Important Safety Instructions	5
FCC STATEMENT	6
Important Safety Notice	7
Safety Precautions	9
Precautions for use	12
Accessories	16
Accessories Supply	16
Remote Control Batteries	17
Kensington security	17
Connections	18
AC cord connection and fixing	18
Cable fixing	18
Video equipment connection	19
Before connecting	20
HDMI 1 and HDMI 2 terminals connection	21
DVI-D IN / DVI-D OUT terminal connection	22
PC IN terminal connection	23
VIDEO IN terminal connection	24
COMPONENT/RGB IN terminal connection	25
SERIAL terminal connection	25
IR IN/IR OUT terminal connection	28
AUDIO OUT terminal connection	28
USB terminal connection	28
Using microSD card	29
USB (OpenPort PLATFORM) terminal connection	30
Micro-USB terminal connection	31
Identifying Controls	32
Main unit	32
Remote Control Transmitter	34
Basic Controls	35
Selecting the input signal	37
RECALL	38
Volume Adjustment	38
Sound mute On / Off	38
OFF TIMER	39

Startup of OpenPort PLATFORM	40
Startup	40
Shutdown	40
Basic Operation/Character Input for OpenPort PLATFORM	41
Remote Control Transmitter	41
Buttons on the main unit	42
USB mouse	43
Software keyboard	43
USB keyboard	44
Operation icon	44
Home Screen of OpenPort PLATFORM	45
[SETUP] screen of OpenPort PLATFORM	46
[INSTALLER] screen of OpenPort PLATFORM	47
[TOOLS] screen of OpenPort PLATFORM	49
[FAVORITE] screen of OpenPort PLATFORM	49
Adding the application to [FAVORITE]	50
Deleting the application from [FAVORITE]	50
[RECENTS] screen of OpenPort PLATFORM	51
Deleting the application from [RECENTS]	51
[STATUS] screen of OpenPort PLATFORM	52
Pre-installed Applications of OpenPort PLATFORM	53
Pre-installed application list	53
[LAN Control] application	54
[Settings] application	55
[CreateShortcut] application	60
[AppStart] application	60
[App Server Setting] application	61
[Shutdown] application	61
[Updater] application	61
[SignageBrowser] application	61
[Version] application	62
[Browser] application	62
[Camera] application	62
Android Standard Home Screen of OpenPort PLATFORM	63
ASPECT Controls	64
Digital ZOOM	65
On-Screen Menu Displays	66
Adjusting Position	68
Auto setup	68
Sound Adjustment	70

Picture Adjustments	71
Picture Profiles	73
Saving profiles	74
Loading profiles	75
Editing profiles	75
Entering profile names	76
Setup menu	78
Signal	78
Screensaver (For preventing image retention)	80
Input label	81
Power management settings	81
OpenPort PLATFORM standby	83
Wobbling	83
No activity power off	83
OSD language	83
Multi display settings	84
Set up timer	85
USB media player settings	85
Function button settings	85
Display orientation	87
OSD position	87
Menu display duration	87
Menu transparency	87
Options Adjustments	88
Using Network Function	97
Necessary environment for computers to be connected	97
Example of network connection	97
Command control	98
Control Command via LAN	98
PJLink protocol	101
Early Warning Software	102
Multi Monitoring & Control Software	102
USB Media Player	103
Function description	103
Preparation	103
Playing back the files	104
Starting / ending Media Player	106
Resume Play function	106
Data Cloning	107
Copying the display data to the USB memory	107
Copying the USB memory data to the display	108
ID Remote Control Function	109
Setting the remote control's ID number	109
Cancelling the setting of remote control's ID number (ID "0")	109

Preset Signals..... 110
OpenPort PLATFORM Shutdown 112
Shipping condition 113
Troubleshooting 114
Specifications 117
Software License 120

**WARNING: RISK OF ELECTRIC SHOCK
DO NOT OPEN**



**WARNING: To reduce the risk of electric shock, do not remove cover or back.
No user-serviceable parts inside. Refer servicing to qualified service personnel.**



The lightning flash with arrow-head within a triangle is intended to tell the user that parts inside the product are a risk of electric shock to persons.



The exclamation point within a triangle is intended to tell the user that important operating and servicing instructions are in the papers with the appliance.

WARNING:

To prevent damage which may result in fire or shock hazard, do not expose this apparatus to rain or moisture.

**Do not place containers with water (flower vase, cups, cosmetics, etc.) above the set.
(including on shelves above, etc.)**

WARNING:

- 1) To prevent electric shock, do not remove cover. No user serviceable parts inside. Refer servicing to qualified service personnel.
- 2) Do not remove the grounding pin on the power plug. This apparatus is equipped with a three pin grounding-type power plug. This plug will only fit a grounding-type power outlet. This is a safety feature. If you are unable to insert the plug into the outlet, contact an electrician.
Do not defeat the purpose of the grounding plug.

Important Safety Instructions

- 1) Read these instructions.
- 2) Keep these instructions.
- 3) Heed all warnings.
- 4) Follow all instructions.
- 5) Do not use this apparatus near water.
- 6) Clean only with dry cloth.
- 7) Do not block any ventilation openings. Install in accordance with the manufacturer's instructions.
- 8) Do not install near any heat sources such as radiators, heat registers, stoves, or other apparatus (including amplifiers) that produce heat.
- 9) Do not defeat the safety purpose of the polarized or grounding-type plug. A polarized plug has two blades with one wider than the other. A grounding type plug has two blades and a third grounding prong. The wide blade or the third prong are provided for your safety. If the provided plug does not fit into your outlet, consult an electrician for replacement of the obsolete outlet.
- 10) Protect the power cord from being walked on or pinched particularly at plugs, convenience receptacles, and the point where they exit from the apparatus.
- 11) Only use attachments / accessories specified by the manufacturer.
- 12) Use only with the cart, stand, tripod, bracket, or table specified by the manufacturer, or sold with the apparatus. When a cart is used, use caution when moving the cart / apparatus combination to avoid injury from tip-over.
- 13) Unplug this apparatus during lightning storms or when unused for long periods of time.
- 14) Refer all servicing to qualified service personnel. Servicing is required when the apparatus has been damaged in any way, such as power-supply cord or plug is damaged, liquid has been spilled or objects have fallen into the apparatus, the apparatus has been exposed to rain or moisture, does not operate normally, or has been dropped.
- 15) To prevent electric shock, ensure the grounding pin on the AC cord power plug is securely connected.



FCC STATEMENT

This equipment has been tested and found to comply with the limits for a class A digital device, pursuant to Part 15 of the FCC Rules. These limits are designed to provide reasonable protection against harmful interference when the equipment is operated in a commercial environment. This equipment generates, uses and can radiate radio frequency energy and, if not installed and used in accordance with the instructions manual, may cause harmful interference to radio communications. Operation of this equipment in a residential area is likely to cause harmful interference in which case the user will be required to correct the interference at his own expense.

FCC CAUTION:

To assure continued compliance, follow the attached installation instructions and use only the provided power supply cord. Any changes or modifications not expressly approved by Panasonic Corp. of North America could void the user's authority to operate this device.

FCC and Industry Canada (IC) RF Exposure Warning:

- **This Display is provided with built-in transmitter: Wireless LAN Adapter with FCC ID: H8N-WLU5150/IC ID:1353A-WLU5150;**
- **This transmitter complies with FCC and IC radiation exposure limits set forth for an uncontrolled environment for mobile use with minimum 8 inches (20 cm) spacing requirement between transmitter and all person's body (excluding extremities of hands, wrist and feet) during wireless modes of operation.**
- **Other third-party wireless transmitters should not be used as they have not been RF exposure evaluated for use with this Display and may not comply with RF exposure requirements.**

<Only for wireless LAN if capable of transmission in the 5.15 ~ 5.25 GHz frequency band>

This product is restricted to indoor use due to its operation in the 5.15 to 5.25 GHz frequency range.

IC requires this product to be used indoors for the frequency range 5.15 to 5.25 GHz to reduce the potential for harmful interference to co-channel Mobile Satellite systems. High power radars are allocated as primary users of the 5.25 to 5.35 GHz and 5.65 to 5.85 GHz bands. These radar stations can cause interference with and/or damage this product.

Declaration of Verification

Model No.

TH-55AF1U, TH-49AF1U, TH-42AF1U

Responsible Party:

Panasonic Corporation of North America

Two Riverfront Plaza, Newark, New Jersey

07102-5490

Contact Source:

Panasonic System Communications Company of North America

1-877-655-2357

General Contact:

<http://shop.panasonic.com/support>

This device complies with Part 15 of the FCC Rules and all applicable IC RSS standards. Operation is subject to the following two conditions: (1) This device may not cause harmful interference, and (2) this device must accept any interference received, including interference that may cause undesired operation.

CANADIAN NOTICE:

This Class A digital apparatus complies with Canadian ICES-003.

WARNING:

- Not for use in a computer room as defined in the Standard for the Protection of Electronic Computer/ Data Processing Equipment, ANSI/NFPA 75.
- For permanently connected equipment, a readily accessible disconnect device shall be incorporated in the building installation wiring.
- For pluggable equipment, the socket-outlet shall be installed near the equipment and shall be easily accessible.

Note:

Image retention may occur. If you display a still picture for an extended period, the image might remain on the screen. However, it will disappear when a general moving picture is displayed for a while.

Trademark Credits

- Microsoft, Windows, Windows Vista and Internet Explorer are the registered trademarks or trademarks of Microsoft Corporation in the United States and/or other countries.
- Macintosh, Mac, Mac OS, OS X and Safari are the trademarks of Apple Inc. registered in the United States and other countries.
- PJLink is a registered or pending trademark in Japan, the United States, and other countries and regions.
- HDMI, the HDMI Logo, and High-Definition Multimedia Interface are trademarks or registered trademarks of HDMI Licensing LLC in the United States and other countries.
- microSDHC logo is the trademark of SD-3C, LLC.
- Google and Android are the trademarks or registered trademarks of Google Inc.
- Bluetooth is the trademark or registered trademark of Bluetooth SIG Inc.
- Wi-Fi, Wi-Fi Direct and WPS are the trademarks or registered trademarks of Wi-Fi Alliance.
- OpenPort PLATFORM is the registered trademark of Panasonic Corporation.

Even if no special notation has been made of company or product trademarks, these trademarks have been fully respected.

Important Safety Notice

WARNING

- 1) To prevent damage which may result in fire or shock hazard, do not expose this appliance to dripping or splashing.
Do not place containers with water (flower vase, cups, cosmetics, etc.) above the set. (including on shelves above, etc.)
No naked flame sources, such as lighted candles, should be placed on / above the set.
- 2) To prevent electric shock, do not remove cover. No user serviceable parts inside. Refer servicing to qualified service personnel.
- 3) Do not remove the earthing pin on the power plug. This apparatus is equipped with a three pin earthing-type power plug. This plug will only fit an earthing-type power outlet. This is a safety feature. If you are unable to insert the plug into the outlet, contact an electrician.
Do not defeat the purpose of the earthing plug.
- 4) To prevent electric shock, ensure the earthing pin on the AC cord power plug is securely connected.

CAUTION

This appliance is intended for use in environments which are relatively free of electromagnetic fields. Using this appliance near sources of strong electromagnetic fields or where electrical noise may overlap with the input signals could cause the picture and sound to wobble or cause interference such as noise to appear.
To avoid the possibility of harm to this appliance, keep it away from sources of strong electromagnetic fields.

WARNING:

This equipment is compliant with Class A of CISPR32. In a residential environment this equipment may cause radio interference.

WARNING (Australia and New Zealand):

This is a class A product. In a domestic environment this product may cause radio interference in which case the user may be required to take adequate measures.

IMPORTANT INFORMATION

If a display is not positioned in a sufficiently stable location, it can be potentially hazardous due to falling. Many injuries, particularly to children, can be avoided by taking simple precautions such as:

- Using cabinets or stands recommended by the manufacturer of the display.
- Only using furniture that can safely support the display.
- Ensuring the display is not overhanging the edge of the supporting furniture.
- Not placing the display on tall furniture (for example, cupboards or bookcases) without anchoring both the furniture and the display to a suitable support.
- Not standing the displays on cloth or other materials placed between the display and supporting furniture.
- Educating children about the dangers of climbing on furniture to reach the display or its controls.

IMPORTANT: THE MOULDED PLUG FOR YOUR SAFETY, PLEASE READ THE FOLLOWING TEXT CAREFULLY.

This display is supplied with a moulded three pin mains plug for your safety and convenience. A 10 amp fuse is fitted in this plug. Shall the fuse need to be replaced, please ensure that the replacement fuse has a rating of 10 amps and that it is approved by ASTA or BSI to BS1362.

Check for the ASTA mark  or the BSI mark  on the body of the fuse.

If the plug contains a removable fuse cover, you must ensure that it is refitted when the fuse is replaced.

If you lose the fuse cover the plug must not be used until a replacement cover is obtained.

A replacement fuse cover can be purchased from your local Panasonic dealer.
Do not cut off the mains plug.

Do not use any other type of mains lead except the one supplied with this display.

The supplied mains lead and moulded plug are designed to be used with this display to avoid interference and for your safety.

If the socket outlet in your home is not suitable, get it changed by a qualified electrician.

If the plug or mains lead becomes damaged, purchase a replacement from an authorized dealer.

WARNING : — THIS DISPLAY MUST BE EARTHED.

How to replace the fuse.

Open the fuse compartment with a screwdriver and replace the fuse.

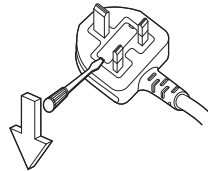

Safety Precautions

WARNING

■ Setup

This LCD Display is for use only with the following optional accessories.

Use with any other type of optional accessories may cause instability which could result in the possibility of injury.

(All of the following accessories are manufactured by Panasonic Corporation.)

- Pedestal
TY-ST43PE8
- Early Warning Software
ET-SWA100 series*1
- Video Wall Manager
TY-VUK10*2

*1: Suffix of the part number may differ depending on the license type.

*2: Supports Ver1.2 or later.

Note

- The part number of the optional accessories are subject to change without notice.

When installing the pedestal, read the operating instructions supplied with it carefully and install properly. Also, always use the overturn prevention accessories.

We are not responsible for any product damage, etc. caused by failures in the installation environment for the pedestal or wall-hanging bracket even during the warranty period.

Small parts can present choking hazard if accidentally swallowed. Keep small parts away from young children. Discard unneeded small parts and other objects, including packaging materials and plastic bags/sheets to prevent them from being played with by young children, creating the potential risk of suffocation.

Do not place the Display on sloped or unstable surfaces, and ensure that the Display does not hang over the edge of the base.

- The Display may fall off or tip over.

Install this unit at a location with minimal vibration and which can support the weight of the unit.

- Dropping or falling of the unit may cause injury or malfunction.

Do not place any objects on top of the Display.

- If foreign objects or water get inside the Display, a short-circuit may occur which could result in fire or electric shock. If any foreign objects get inside the Display, please consult your local Panasonic dealer.

Transport only in upright position!

- Transporting the unit with its display panel facing upright or downward may cause damage to the internal circuitry.

Ventilation should not be impeded by covering the ventilation openings with items such as newspapers, table cloths and curtains.

For sufficient ventilation, see page 12.

Caution - For use only with UL Listed Wall Mount Bracket with minimum weight/load 25.0 kg (55.2 lbs).

When installing the Display vertically;

When installing the Display vertically, be sure that the Power Indicator comes to the downside. Heat is generated and it may cause fire or damage to the Display.

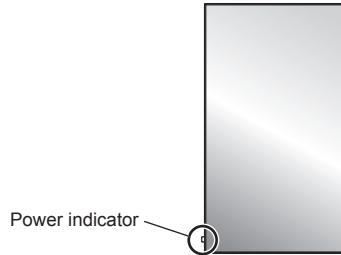

Cautions for Wall or Pedestal Installation

- Wall or Pedestal installation should be performed by an installation professional. Installing the Display incorrectly may lead to an accident that results in death or serious injury. Use the optional Pedestal. (see page 9)
- When installing on a wall, a wall hanging bracket that conforms to VESA standards must be used.

55-inch model	49-inch model	: VESA 400×400
42-inch model		: VESA 200×200

(see page 12)
- Before installation, be sure to check if the mounting location has enough strength to support the weight of the LCD display and the wall hanging bracket for anti drop.
- If you terminate the use of the Display on the Wall or Pedestal, ask a professional to remove the Display as soon as possible.
- When mounting the Display on the wall, prevent the mounting screws and power cable from contacting metal objects inside the wall. An electric shock may occur if they contact metal objects inside the wall.

Do not install the product to a place where the product is exposed to direct sunlight.

- If the screen is exposed to direct sunlight, the liquid crystal panel may have adverse effect.

■ When using the LCD Display

The Display is designed to operate on 110 - 127 or 220 - 240 V AC, 50/60 Hz.

Do not cover the ventilation holes.

- Doing so may cause the Display to overheat, which can cause fire or damage to the Display.

Do not stick any foreign objects into the Display.

- Do not insert any metal or flammable objects into the ventilations holes or drop them onto the Display, as doing so can cause fire or electric shock.

Do not remove the cover or modify it in any way.

- High voltages which can cause severe electric shocks are present inside the Display. For any inspection, adjustment and repair work, please contact your local Panasonic dealer.

Ensure that the mains plug is easily accessible.

The mains plug shall be connected to a mains socket outlet with a protective earthing connection.

Do not use any power supply cord other than that provided with this unit.

- Doing so may cause short-circuit, generates heat, etc., which could cause electric shock or fire.

Do not use the supplied power supply cord with any other devices.

- Doing so could cause electric shock or fire.

Securely insert the power supply plug as far as it will go.

- If the plug is not fully inserted, heat may be generated which could cause fire. If the plug is damaged or the wall socket is loose, they shall not be used.

Do not handle the power supply plug with wet hands.

- Doing so may cause electric shocks.

Do not do anything that may damage the power cable. When disconnecting the power cable, pull on the plug body, not the cable.

- Do not damage the cable, make any modifications to it, place heavy objects on top of it, heat it, place it near any hot objects, twist it, bend it excessively or pull it. To do so may cause fire and electric shock. If the power cable is damaged, have it repaired at your local Panasonic dealer.

Do not touch the power supply cord or the plug directly by hand when they are damaged.

Electric shock could occur.

Do not remove covers and NEVER modify the Display yourself

- Do not remove the rear cover as live parts are accessible when it is removed. There are no user serviceable parts inside. (High-voltage components may cause serious electrical shock.)
- Have the Display checked, adjusted, or repaired at your local Panasonic dealer.

Keep the AAA/R03/UM4 batteries (supplied) and anti-theft cover of microSD card (see page 29) out of reach of children. If accidentally swallowed, it will be harmful to the body.

- Please contact a doctor immediately in case you doubt that the child may have swallowed it.

If the Display is not going to be used for any prolonged length of time, unplug the power supply plug from the wall outlet.

Picture noise may occur if you connect / disconnect the cables connected to the input terminals you are currently not watching, or if you turn the power of the video equipment on / off, but it is not a malfunction.

Data or the settings could be lost if the unit is turned off by disconnecting the power plug, etc., while OpenPort PLATFORM system is operating.

- Generally, when it is operating, be sure to shut down OpenPort PLATFORM system first, and then remove the power plug, etc. (see page 40)

To prevent the spread of fire, keep candles or other open flames away from this product at all times.



CAUTION

If problems or malfunction occur, stop using immediately.

■ If problems occur, unplug the power supply plug.

- Smoke or an abnormal odour come out from the unit.
- No picture appears or no sound is heard, occasionally.
- Liquid such as water or foreign objects got inside the unit.
- The unit has deformed or broken parts.

If you continue to use the unit in this condition, it could result in fire or electric shock.

- Turn the power off immediately, unplug the power supply plug from the wall outlet, and then contact the dealer for repairs.
- To cut off the power supply to this Display completely, you need to unplug the power supply plug from the wall outlet.
- Repairing the unit yourself is dangerous, and shall never be done.
- To enable to unplug the power supply plug immediately, use the wall outlet which you can reach easily.

■ Do not touch the unit directly by hand when it is damaged.

Electric shock could occur.

■ When using the LCD Display

Do not bring your hands, face or objects close to the ventilation holes of the Display.

- Heated air comes out from the ventilation holes at the top of Display will be hot. Do not bring your hands or face, or objects which cannot withstand heat, close to this port, otherwise burns or deformation could result.

At least 2 people are required to carry or unpack this unit.

- If this is not observed, the unit may drop, resulting in injury.

Be sure to disconnect all cables before moving the Display.

- If the Display is moved while some of the cables are still connected, the cables may become damaged, and fire or electric shock could result.

Disconnect the power supply plug from the wall socket as a safety precaution before carrying out any cleaning.

- Electric shocks can result if this is not done.

Clean the power cable regularly to prevent it becoming dusty.

- If dust built up on the power cord plug, the resultant humidity can damage the insulation, which could result in fire. Pull the power cord plug out from the wall outlet and wipe the mains lead with a dry cloth.

Do not step on, or hang from the display or the Pedestal.

- They might tip over, or might be broken and it may result in injury. Pay special attention to the children.

Do not reverse the polarity (+ and -) of the battery when inserting.

- Mishandling the battery may cause its explosion or leakage, resulting in fire, injury or damage to surrounding properties.
- Insert the battery correctly as instructed. (see page 17)

Remove the batteries from the remote control transmitter when not using for a long period of time.

- The battery may leak, heat, ignite or burst, resulting in fire or damage to surrounding properties.

Do not burn or breakup batteries.

- Batteries must not be exposed to excessive heat such as sunshine, fire or the like.

Do not turn the Display upside down.

Do not position the unit with its display panel facing upright.

Precautions for use

Cautions when installing

Do not set up the Display outdoors.

- The Display is designed for indoor use.

Environmental temperature to use this unit

- When using the unit where it is below 1 400 m (4 593 ft) above sea level: 0 °C to 40 °C (32 °F to 104 °F)
- When using the unit at high altitudes (1 400 m (4 593 ft) and higher and below 2 800 m (9 186 ft) above sea level): 0 °C to 35 °C (32 °F to 95 °F)

Do not install the unit where it is 2 800 m (9 186 ft) and higher above sea level.

- Failure to do so may shorten the life of the internal parts and result in malfunctions.

Required space for ventilation

When using the pedestal (optional accessory), leave a space of 10 cm (3 15/16") or more at the top, left and right, and 5 cm (1 31/32") or more at the rear, and also keep the space between the bottom of the display and the floor surface.

If using some other setting-up method (wall-hanging, etc.), follow the manual of it. (If there is no specific indication of installation dimension in the installation manual, leave a space of 10 cm (3 15/16") or more at the top, bottom, left and right, and 5 cm (1 31/32") or more at the rear.)

Minimum distance:

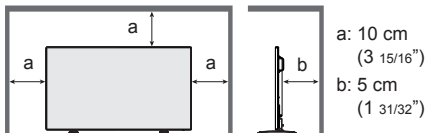

About the screws used when using a wall hanging bracket that conforms to VESA standards

Inch model	Screw pitch for installation	Depth of screw hole	Screw (quantity)
55	400 mm × 400 mm	10 mm	M6 (4)
49	400 mm × 400 mm	10 mm	M6 (4)
42	200 mm × 200 mm	10 mm	M6 (4)

When installing, do not use the screw holes (situated at the bottom of the display's back) as shown in the following figures.

It may damage the LCD panel.

55-inch model



49-inch model



42-inch model



Be careful of the movable structure of the power indicator and remote control sensor.

- As factory default, the power indicator and remote control sensor are stored in the main unit. For normal use, pull out the remote control sensor from the edge side of the main unit by operating the lever on the rear panel. Depending on the setup condition such as when using the multi display, store the remote control sensor in the main unit. (see page 32)

Do not grab the liquid crystal panel.

- Do not forcibly press the liquid crystal panel, or push it with a pointed object. Applying a strong force to the liquid crystal panel will cause unevenness of the screen display, resulting in malfunction.

Depending on the temperature or humidity conditions, uneven brightness may be observed. This is not a malfunction.

- This unevenness will disappear while applying current continuously. If not, consult the distributor.

Request Regarding Security

When using this product, take safety measures against the following incidents.

- Personal information being leaked via this product
- Unauthorized operation of this product by a malicious third party
- Interfering or stopping of this product by a malicious third party

Take sufficient security measures. (see page 54, 98)

- Set a password for the LAN control and restrict the users who can log in.
- Make your password difficult to guess as much as possible.
- Change your password periodically.
- Panasonic Corporation or its affiliate companies will never ask for your password directly. Do not divulge your password in case you receive such inquiries.
- The connecting network must be secured by a firewall, etc.
- When disposing the product, initialize the data before disposing. [Factory data reset] (see page 59) or [Shipping] (see page 113)

About Wireless LANs

- The advantage of a wireless LAN is that information can be exchanged between a PC or other such equipment and an access point using radio waves as long as you are within range for radio transmissions.

On the other hand, because the radio waves can travel through obstacles (such as walls) and are available everywhere within a given range, problems of the type listed below may occur if security-related settings are not made.

- A malicious third-party may intentionally intercept and monitor transmitted data including the content of e-mail and personal information such as your ID, password, and/or credit card numbers.
- A malicious third-party may access your personal or corporate network without authorization and engage in the following types of behaviour.
Retrieve personal and/or secret information (information leak)
Spread false information by impersonating a particular person (spoofing)
Overwrite intercepted communications and issue false data (tampering)
Spread harmful software such as a computer virus and crash your data and/or system (system crash)
- Since most wireless LAN adapters or access points are equipped with security features to take care of these problems, you can reduce the possibility of these problems occurring when using this product by making the appropriate security settings for the wireless LAN device.
- Some wireless LAN devices may not be set for security immediately after purchase. To decrease the possibility of occurrence of security problems, before using any wireless LAN devices, be absolutely sure to make all security-related settings according to the instructions given in the operation manuals supplied with them.
Depending on the specifications of the wireless LAN, a malicious third-party may be able to break security settings by special means.
Please contact Panasonic if you need help taking care of security settings or other such.
If you cannot perform security settings for your wireless LAN by yourself, please contact the Panasonic Support Center.
- Panasonic asks customers to thoroughly understand the risk of using this product without making security settings, and recommends that the customer make security settings at their own discretion and responsibility.

About built-in wireless LAN

CAUTION:

Be aware of the following limits before using the Wireless LAN Module.

- To use the Wireless LAN Module, an access point needs to be obtained.
- Do not use the Wireless LAN Module to connect to any wireless network (SSID*) for which you do not have usage rights. Such networks may be listed as a result of searches. However, using them may be regarded as illegal access.

* SSID is a name for identifying a particular wireless network for transmission.

- Do not subject the Wireless LAN Module to high

temperatures, direct sunlight or moisture.

- Do not bend, or subject the Wireless LAN Module to strong impacts.
- Do not disassemble or alter the Wireless LAN Module in any way.
- Do not attempt to install the Wireless LAN Module in any incompatible device.
- Do not remove the Wireless LAN Module from the host product during operations.
- Data transmitted and received over radio waves may be intercepted and monitored.
- To avoid malfunctions caused by radio wave interface, keep the host product away from the devices such as other wireless LAN devices, microwaves and the devices that use 2.4 GHz and 5 GHz signals when using the Wireless LAN Module.
- When noises occur due to the static electricity, etc., the host product might stop operating for the protection of the devices. In this case, turn the host product Off with Mains power On / Off switch, then turn it On again.
- Depending on the area, this Wireless LAN Module may not be available.

Notes on Using Wireless Connection

Wireless connection function of the Display uses radio waves in the 2.4 GHz and 5 GHz bands.

A radio station license is not required, but be sure to read and fully understand the following items before use.

Do not use near other wireless equipment.

- The following equipment may use radio waves in the same band as the Display.

When the Display is used near these devices, radio wave interference may make communication impossible, or the communication speed may become slower.

- Microwave ovens, etc.
- Industrial, chemical and medical equipment, etc.
- In-plant radio stations for identifying moving objects such as those used in factory manufacturing lines, etc.
- Designated low-power radio stations

If at all possible, avoid the use of cellular phones, TV sets or radios near the Display.

- Cellular phones, TV sets, radios and similar devices use different radio bands from the Display, so there is no effect on wireless communication or the transmission and reception of these devices. However, radio waves from the Display may produce audio or video noise.

Wireless communication radio waves cannot penetrate steel reinforcements, metal, concrete, etc.

- Communication is possible through walls and floors made from materials such as wood and glass (except glass containing wire mesh), but not through walls and floors made from steel reinforcements, metal, concrete, etc.

Avoid using the Display in locations prone to static electricity.

- If the Display is used in a location prone to static electricity, such as on a carpet, the wireless LAN or wired LAN connection may be lost.
- If this happens, eliminate the source of static electricity or electromagnetic noise and reconnect to the wireless LAN or wired LAN.

Using the Display outside the country

- It is forbidden to take the Display outside the country or region where you purchased it, so use it only in the said country or region. Also, note that depending on countries or regions there are restrictions on the channels and frequencies at which you can use the wireless LAN.

Available wireless LAN channels

- The channels (frequency range) that can be used differ according to the country or region. Refer to the table below.

Country or region: Global

Channels used: Passive scanning

Standard	Frequency band (Centre frequency)
IEEE802.11a/n	5.180 GHz - 5.825 GHz
IEEE802.11b/g/n	2.412 GHz - 2.472 GHz

- The frequency and channel differ depending on the country.
- The passive scanning is performed by changing radio to the channel being scanned in each country.
- Please use the wireless LAN feature in compliance with the laws of each country.

For Mexico:

Operation of this equipment is subject to the following two conditions:

- (1) this equipment might not have a harmful interference and
- (2) this equipment must accept any interference, including one that might cause it to malfunction

For Jamaica:

- This product contains Type Approved Modules by Jamaica.

LCD Display



Declaration of Conformity (DoC)

"Hereby, Panasonic Corporation declares that this Display is in compliance with the essential requirements and other relevant provisions of the Directive 1999/5/EC."

If you want to get a copy of the original DoC of this Display, please visit the following website:
<http://www.doc.panasonic.de>

Authorized Representative:
Panasonic Testing Centre

Panasonic Service Europe, a division of Panasonic Marketing Europe GmbH
Winsbergring 11, 22525 Hamburg, Germany

This Display is intended to be used in the following countries.

Albania, Austria, Belgium, Bulgaria, Cyprus, Czech Republic, Denmark, Estonia, Finland, France, Germany, Greece, Hungary, Italy, Iceland, Latvia, Lithuania, Luxembourg, Malta, Netherlands, Norway, Poland, Portugal, Romania, Slovakia, Slovenia, Spain, Sweden, Switzerland, Turkey, United Kingdom

The wireless LAN feature of this Display shall exclusively be used inside buildings.

UAE



Singapore



Thailand

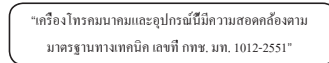

Notes on Using Wired LAN

When setting up the Display at a place, where electric static occurs often, take a sufficient antistatic measure before start using.

- When the Display is used at a location, where static electricity occurs often, such as on a carpet, a wired LAN communication is disconnected more often. In that case, remove static electricity and the noise source that may cause problems with an antistatic mat, and re-connect the wired LAN.
- In rare cases, the LAN connection is disabled due to static electricity or noise. In that case, turn off the power of the Display and the connected devices once and then re-turn on the power.

The Display may not work properly due to strong radio wave from the broadcast station or the radio.

- If there is any facility or equipment, which outputs strong radio wave, near the installation location, set up the Display at a location sufficiently far from the source of the radio wave. Or, wrap the LAN cable connected to the LAN terminal by using a piece of metal foil or a metal pipe, of which is grounded at both ends.

Cleaning and maintenance

The front of the display panel has been specially treated. Wipe the surface of the display panel gently using only a cleaning cloth or a soft, lint-free cloth.

- If the surface is particularly dirty, wipe with a soft, lint-free cloth which has been soaked in pure water or water in which neutral detergent has been diluted 100 times, and then wipe it evenly with a dry cloth of the same type until the surface is dry.
- Do not scratch or hit the surface of the panel with fingernails or other hard objects, otherwise the surface may become damaged. Furthermore, avoid contact with volatile substances such as insect sprays, solvents and thinner, otherwise the quality of the surface may be adversely affected.

If the cabinet becomes dirty, wipe it with a soft, dry cloth.

- If the cabinet is particularly dirty, soak the cloth in water to which a small amount of neutral detergent has been added and then wring the cloth dry. Use this cloth to wipe the cabinet, and then wipe it dry with a dry cloth.
- Do not allow any detergent to come into direct contact with the surface of the Display. If water droplets get inside the unit, operating problems may result.
- Avoid contact with volatile substances such as insect sprays, solvents and thinner, otherwise the quality of the cabinet surface may be adversely affected or the coating may peel off. Furthermore, do not leave it for long periods in contact with articles made from rubber or PVC.

Usage of a chemical cloth

- Do not use a chemical cloth for the panel surface.
- Follow the instructions for the chemical cloth to use it for the cabinet.

Disposal

When disposing the product, ask your local authority or dealer about the correct methods of disposal.

For USA-California Only

This product contains a CR Coin Cell Lithium Battery which contains Perchlorate Material - special handling may apply.

See www.dtsc.ca.gov/hazardouswaste/perchlorate

Accessories

Accessories Supply

Check that you have the accessories and items shown

Operating Instructions (CD-ROM × 1)

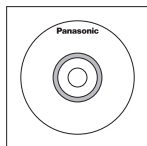

Remote Control Transmitter × 1

- DPVF1203ZA



Batteries for the Remote Control Transmitter

(AAA/R03/UM4 type × 2)

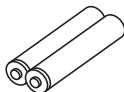

Clamper × 3

- TZZ00000694A

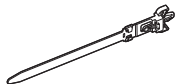

Power supply cord

(Approx. 2 m)

TH-55AF1U

TH-49AF1U

TH-42AF1U

- 1JP155AF1U

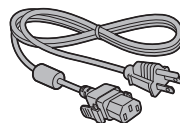

TH-55AF1W

TH-49AF1W

TH-42AF1W

- 1JP155AF1W

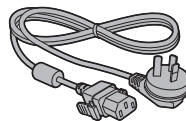

- 2JP155AF1W

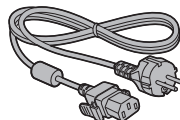

- 3JP155AF1W

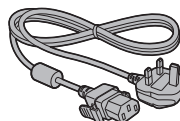

Attention

- Store small parts in an appropriate manner, and keep them away from young children.
- The part numbers of accessories are subject to change without notice. (The actual part number may differ from the ones shown above.)
- In case you lost accessories, please purchase them from your dealer. (Available from the customer service)
- Dispose the packaging materials appropriately after taking out the items.

Remote Control Batteries

1. Pull and hold the hook, then open the battery cover.

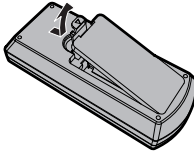

2. Insert batteries - note correct polarity (+ and -).

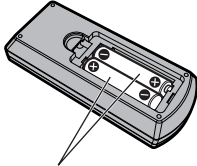

AAA/R03/UM4 type

3. Replace the cover.

Helpful Hint

- For frequent remote control users, replace old batteries with Alkaline batteries for longer life.



Precaution on battery use

Incorrect installation of the batteries can cause battery leakage and corrosion that will damage the remote control transmitter.

Disposal of batteries should be in an environment-friendly manner.

Observe the following precaution:

1. Batteries shall always be replaced as a pair. Always use new batteries when replacing the old set.
2. Do not combine a used battery with a new one.
3. Do not mix battery types (example: "Zinc Carbon" with "Alkaline").
4. Do not attempt to charge, short-circuit, disassemble, heat or burn used batteries.
5. Battery replacement is necessary when remote control acts sporadically or stops operating the Display set.
6. Do not burn or breakup batteries.
7. Batteries must not be exposed to excessive heat such as sunshine, fire or the like.

Kensington security

The security slot of this unit is compatible with the Kensington security slot.

55-inch model

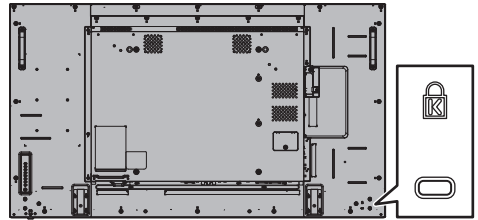

49-inch model

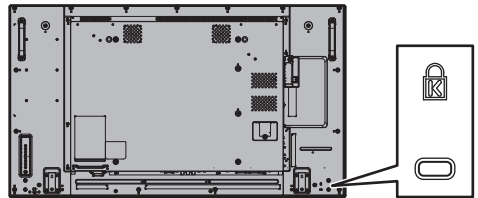

42-inch model

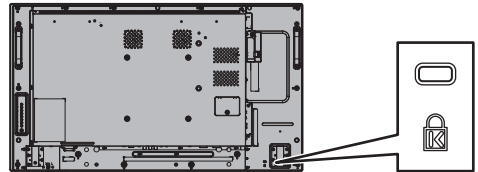

Connections

AC cord connection and fixing

Back of the unit

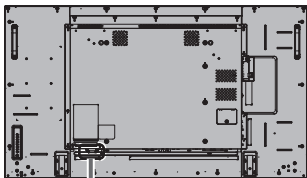

AC cord fixing

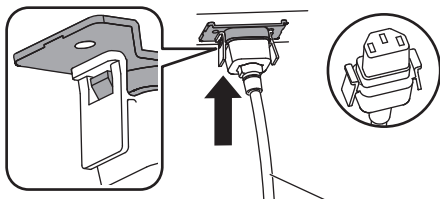

AC cord (supplied)

Plug the connector into the display unit.

Plug the connector until it clicks.

Note

- Make sure that the connector is locked on both the left and right sides.

Unplug the AC cord

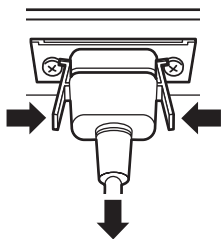

Unplug the connector pressing the two knobs.

Note

- When disconnecting the AC cord, be absolutely sure to disconnect the AC cord plug at the socket outlet first.
- The supplied AC cord is for this unit exclusive use. Do not use this for other purposes.

Cable fixing

Note

- 3 clampers are supplied with this unit. Fix the cables at 3 locations using the holes for clampers as shown below.

If you need more clampers, purchase them from your dealer. (Available from the customer service)

55-inch model

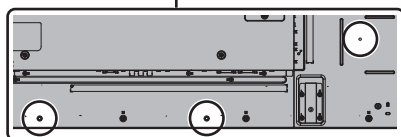
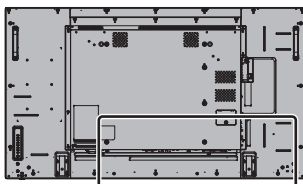

- The positions of the holes are the same for 42-inch and 49-inch models.

1. Attach the clammer

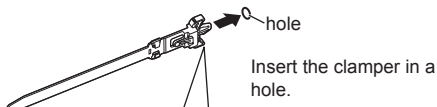

To remove from the unit:

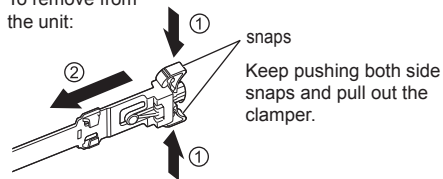

2. Bundle the cables

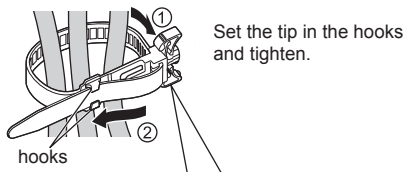

To loosen:

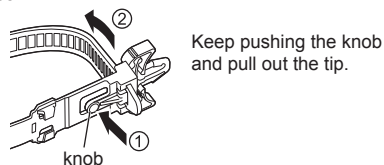

Video equipment connection

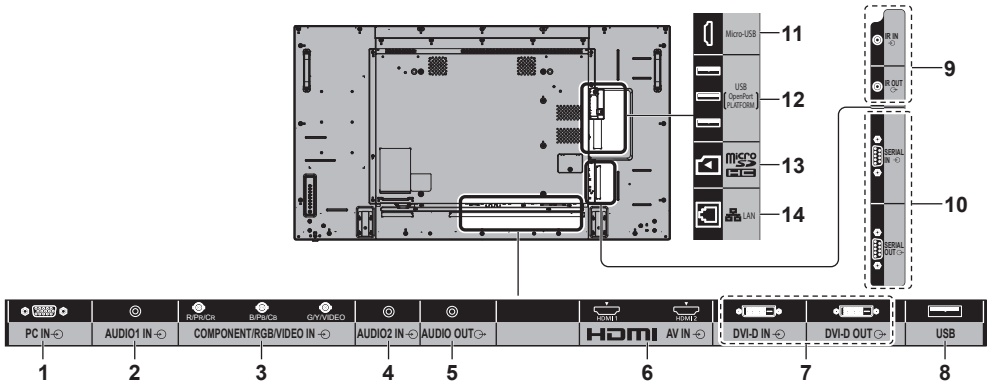

1 PC IN:	PC Input Terminal Connect to video terminal of PC, video equipment with "YPbPr / YCbCr" or "RGB" output. (see page 23)
2 AUDIO1 IN:	Audio input terminal shared with DVI-D IN and PC IN (see page 22, 23)
3 COMPONENT / RGB / VIDEO IN:	COMPONENT / RGB Video Input Terminal (R/Pr/Cr, B/Pb/ Cb, G/Y) Connect to video equipment with "YPbPr / YCbCr" or "RGB" output. (see page 25) Composite Video Input Terminal (VIDEO) Connect to video equipment with Composite signal output. (see page 24)
4 AUDIO2 IN:	Audio Input Terminal shared with COMPONENT/RGB IN and VIDEO IN (see page 24, 25)
5 AUDIO OUT:	Analogue Audio Output Terminal Connect to audio equipment with analogue audio input terminal. (see page 28)
6 AV IN (HDMI 1, HDMI 2):	HDMI Input Terminal Connect to video equipment such as VCR or DVD player, etc. (see page 21)

7 DVI-D IN, DVI-D OUT:	DVI-D Input / Output Terminal Connect to video equipment with DVI-D output. Also, when displaying the picture by daisy chaining multiple displays, connect to the other display (DVI-D OUT). The DVI-D output function is enabled only when the picture is displayed via DVI-D IN. (see page 22)
8 USB:	USB Terminal Connect the USB memory to use [USB media player]. Also, this can be used to supply power of up to 5V/1A to an external device when the picture is displayed. (see page 28)
9 IR IN, IR OUT:	Infrared Signal Input / Output Terminal Use this when operating more than one display with one remote control. (see page 28)
10 SERIAL IN, SERIAL OUT:	SERIAL Input / Output Terminal Control the Display by connecting to PC. (see page 25)

11 Micro-USB:	<p>Micro-USB Terminal</p> <p>By connecting the unit to the PC using the Micro-USB cable, data in the storage of the OpenPort PLATFORM system can be read or written from the PC. (see page 31)</p>
12 USB (OpenPort PLATFORM):	<p>USB Terminal for OpenPort PLATFORM</p> <p>Used by connecting a USB memory as external storage for OpenPort PLATFORM system. (see page 30)</p> <p>With OpenPort PLATFORM input, it is also possible to connect and use USB devices such as a USB mouse, a USB keyboard, etc. (see page 43, 44)</p>
13 microSD :	<p>microSD card slot</p> <p>Used by attaching a microSD card as external storage for OpenPort PLATFORM system. (see page 29)</p>
14 LAN:	<p>LAN Terminal</p> <p>Control the Display by connecting to Network. (see page 97)</p> <p>With OpenPort PLATFORM input, it is possible to display WEB pages or download applications from the server. (see page 48, 62)</p>

Before connecting

- Before connecting cables, carefully read the operating instructions for the external device to be connected.
- Turn off the power of all devices before connecting cables.
- Take note of the following points before connecting the cables. Failure to do so may result in malfunctions.
 - When connecting a cable to the unit or a device connected to the unit itself, touch any nearby metallic objects to eliminate static electricity from your body before performing work.
 - Do not use unnecessarily long cables to connect a device to the unit or to the unit body. The longer the cable, the more susceptible to noise it becomes. Since using a cable while it is wound makes it act like an antenna, it is more susceptible to noise.
 - When connecting cables, connect GND first, then insert the connecting terminal of the connecting device in a straight manner.
- Acquire any cable necessary to connect the external device to the system that is neither supplied with the device nor available as an option.
- If the outer shape of the plug of a connection cable is large, it may come in contact with the periphery such as a back cover or the plug of an adjacent connection cable. Use a connection cable with the suitable plug size for the terminal alignment.
- If video signals from video equipment contain too much jitter, the images on the screen may wobble. In this case, a time base corrector (TBC) must be connected.
- When the sync signals output from PC or video equipment are disturbed, for example, when changing settings of video output, the colour of the video may be disturbed temporarily.
- The unit accepts Composite video signals, YCbCr/YPbPr signals, analogue RGB signals and digital signals.
- Some PC models are not compatible with the unit.
- Use cable compensator when you connect devices to the unit using long cables. Otherwise the image may not display properly.
- Refer to "Preset Signals" (see page 110) for the types of video signals that can be displayed with the unit.

HDMI 1 and HDMI 2 terminals connection

Note

- Video equipment and HDMI cable shown are not supplied with this unit.
- Some HDMI equipment may not be able to display picture.
- For audio, it is also possible to use AUDIO1 IN or AUDIO2 IN terminal input. (For [Audio input select] function, see page 92.)

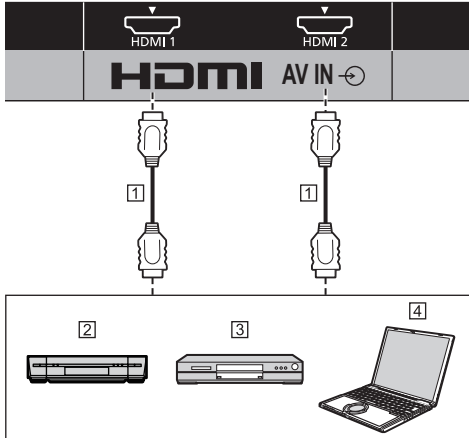

- 1 HDMI cable (commercially available)
- 2 Video Cassette Recorder
- 3 DVD Player
- 4 PC

Pin assignments and signal names for HDMI Terminal

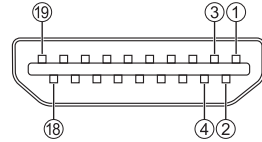

Pin No.	Signal name
1	T.M.D.S Data2+
2	T.M.D.S Data2 Shield
3	T.M.D.S Data2-
4	T.M.D.S Data1+
5	T.M.D.S Data1 Shield
6	T.M.D.S Data1-
7	T.M.D.S Data0+
8	T.M.D.S Data0 Shield
9	T.M.D.S Data0-
10	T.M.D.S Clock+
11	T.M.D.S Clock Shield
12	T.M.D.S Clock-
13	CEC
14	_____
15	SCL
16	SDA
17	DDC/CEC Ground
18	+5V DC
19	Hot Plug Detect

DVI-D IN / DVI-D OUT terminal connection

Note

- Video equipment and cables shown are not supplied with this unit.
- Use the DVI-D cable complying with the DVI standard. Image deterioration may occur depending on the length or the quality of the cable.
- DVI-D IN terminal is for Single Link only.
- For audio, it is also possible to use AUDIO2 IN terminal input. (For [Audio input select] function, see page 92.)

Shared with PC IN.

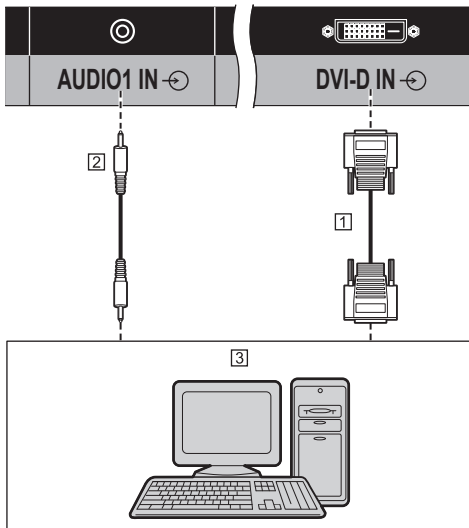

- 1 DVI-D video cable (Within 5 m) (commercially available)
- 2 Stereo mini plug (M3) cable (commercially available)
- 3 PC with DVI-D video out

Daisy chain connection

It is possible to daisy chain multiple displays when displaying the picture on multi screen, etc.

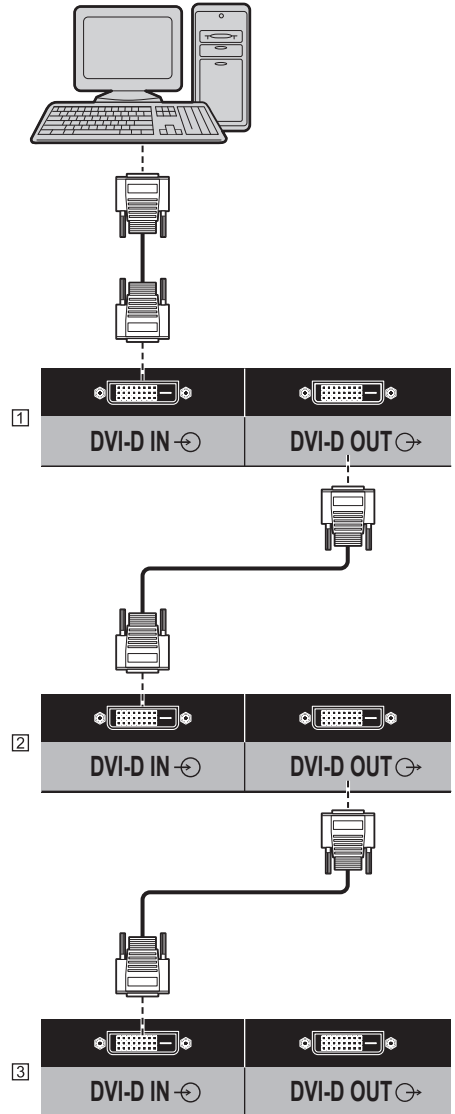

- 1 First display
- 2 Second display
- 3 Third display

Note

- It is possible to daisy chain up to 10 displays. However, the number of connectable displays may be limited depending on the cables, signals, the devices used, etc.

- When inputting HDCP signal, it is possible to daisy chain up to 8 displays.
- The DVI-D output function is enabled when the picture is displayed via DVI-D IN. When using the daisy-chain connection method, all the displays should be in the state where the picture is displayed via DVI-D IN.

Pin assignments and signal names for DVI-D Input/Output

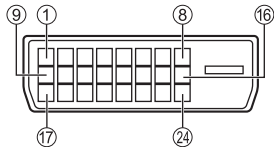

Pin No.	Signal Name
①	T.M.D.S. data 2-
②	T.M.D.S. data 2+
③	T.M.D.S. data 2 shield
④	_____
⑤	_____
⑥	DDC clock
⑦	DDC data
⑧	_____
⑨	T.M.D.S. data 1-
⑩	T.M.D.S. data 1+
⑪	T.M.D.S. data 1 shield
⑫	_____
⑬	_____
⑭	+5 V DC
⑮	GND (Ground)
⑯	Hot plug detect
⑰	T.M.D.S. data 0-
⑱	T.M.D.S. data 0+
⑲	T.M.D.S. data 0 shield
⑳	_____
㉑	_____
㉒	T.M.D.S. clock shield
㉓	T.M.D.S. clock+
㉔	T.M.D.S. clock-

PC IN terminal connection

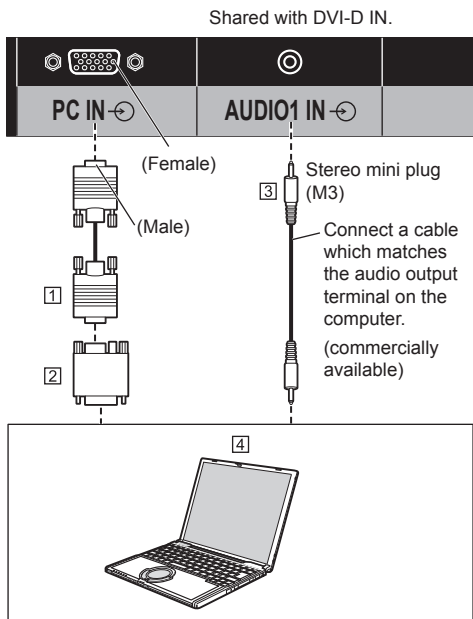

- ① Mini D-sub 15p cable (commercially available)
- ② Conversion adapter (if necessary) (commercially available)
- ③ Stereo mini plug (M3) cable (commercially available)
- ④ PC

The type of computer signal that can be connected

- With regard to the typical PC input signals that are described in “Preset Signals” (see page 110), adjustment values such as for the standard picture positions and sizes have already been stored in this unit.
(Computer signals which can be input are those with a horizontal scanning frequency of 30 to 110 kHz and vertical scanning frequency of 48 to 120 Hz.)
- The display resolution is a maximum of 1 440 × 1 080 dots when the aspect mode is set to [4:3], and 1 920 × 1 080 dots when the aspect mode is set to [16:9]. If the display resolution exceeds these maximums, it may not be possible to show fine detail with sufficient clarity.
- In [ENGLISH(US)] OSD language, [16:9] is displayed as [FULL].

Note

- The PC IN terminal is DDC2B-compatible. If the computer being connected is not DDC2B-compatible, you will need to make setting changes to the computer at the time of connection.
- There is no need to use an adapter for computers with DOS/IV compatible Mini D-sub 15P terminal.

- The computer shown in the illustration is for example purposes only.
- Additional computer, cables and conversion adapter shown are not supplied with this set.
- Do not set the horizontal and vertical scanning frequencies for PC signals which are above or below the specified frequency range.
- Component Input is possible with the pin 1, 2, 3 of the Mini D-sub 15P Connector.
- Change the [Component/RGB-in select] setting in the [Signal] menu to [Component] (when Component signal connection) or [RGB] (when RGB signal connection). (see page 78)
- For audio, it is also possible to use AUDIO2 IN terminal input. (For [Audio input select] function, see page 92.)

Pin assignments and signal names for PC Input Terminal (Mini D-sub 15P)

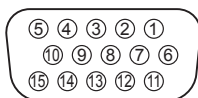

Pin No.	Signal Name
①	R (P _R /C _R)
②	G (Y)
③	B (P _B /C _B)
④	NC (not connected)
⑤	GND (Ground)
⑥	GND (Ground)
⑦	GND (Ground)
⑧	GND (Ground)
⑨	+5 V DC
⑩	GND (Ground)
⑪	NC (not connected)
⑫	SDA
⑬	HD/SYNC
⑭	VD
⑮	SCL

VIDEO IN terminal connection

Note

- Video equipment, connection cables and conversion plugs are not supplied with this unit.
- For audio, it is also possible to use AUDIO1 IN terminal input. (For [Audio input select] function, see page 92.)

Shared with COMPONENT/RGB IN.

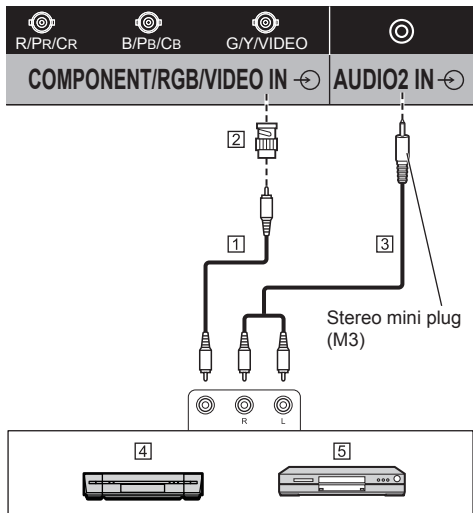

- ① Video pin cable (commercially available)
- ② Pin-BNC conversion plug (commercially available)
- ③ Stereo audio cable (commercially available)
- ④ Video Cassette Recorder
- ⑤ DVD Player

COMPONENT/RGB IN terminal connection

Note

- Video equipment, cables and conversion adapter shown are not supplied with this unit.
- For audio, it is also possible to use AUDIO1 IN terminal input. (For [Audio input select] function, see page 92.)

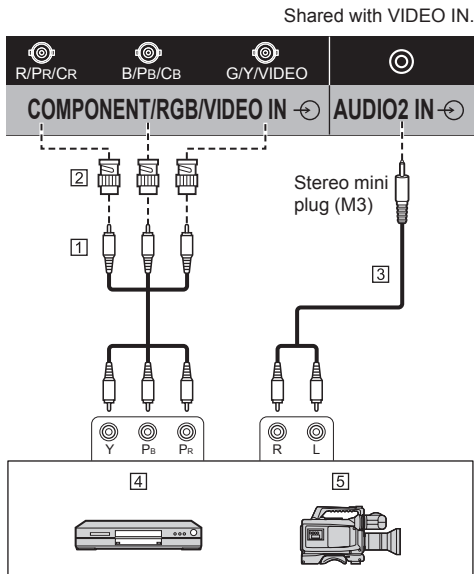

- 1 Video pin cable (commercially available)
- 2 Pin-BNC conversion plug (commercially available)
- 3 Stereo audio cable (commercially available)
- 4 DVD Player
- 5 RGB camera

Note

- In accordance with the input signal connected to COMPONENT/RGB IN terminal, select the input [Component] or [RGB] in [Signal] - [Component/RGB-in select]. (see page 78)
- The RGB signal input to COMPONENT/RGB IN terminal corresponds to "SYNC ON G" only.

SERIAL terminal connection

The SERIAL terminal conforms to the RS-232C interface specification, so that the Display can be controlled by a computer which is connected to this terminal.

(Male)

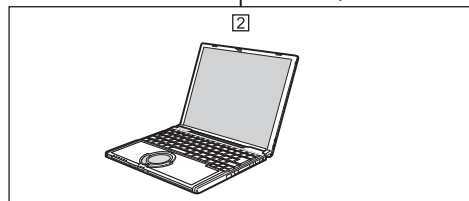
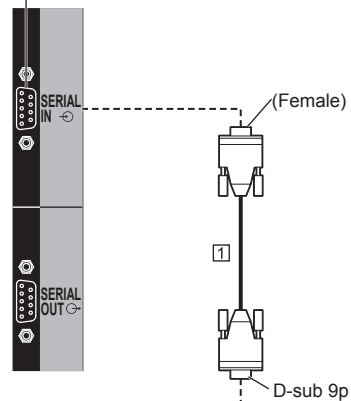

- 1 RS-232C Straight cable (commercially available)
- 2 PC

Note

- Use the RS-232C straight cable to connect the computer to the Display.
- Additional computer and cables shown are not supplied with this set.

It is possible to daisy chain multiple displays, and then control the specific display with PC.

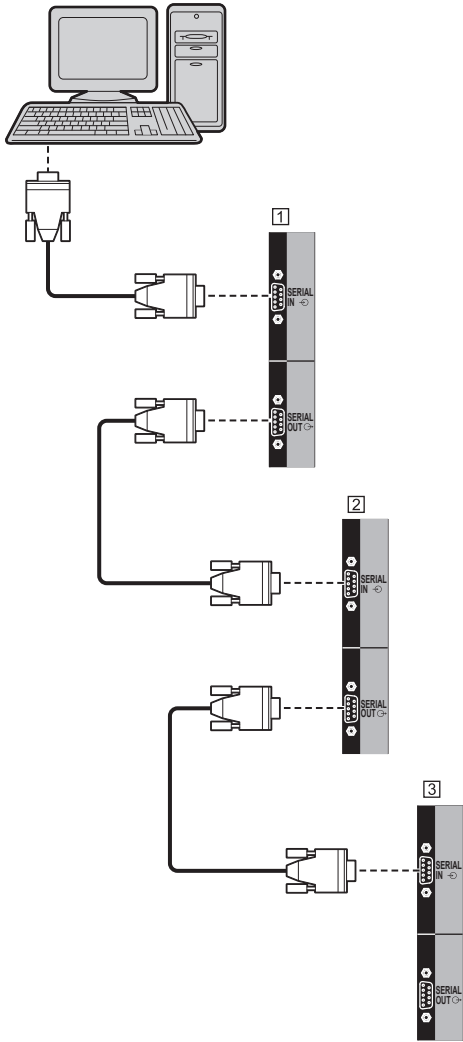

- 1 First display
- 2 Second display
- 3 Third display

Note

- When daisy chaining, set [Options] - [Serial daisy chain position]. (see page 94)
- When daisy chaining, use a straight cable which pin No. ② to ⑥ are hard wired.

Pin assignments and signal names for SERIAL Terminal

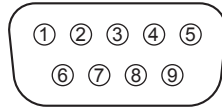

Pin No.	Signal Name	
①	NC (not connected)	
②	RXD	
③	TXD	
④	Non use	
⑤	GND (Ground)	
⑥	Non use	
⑦	RTS] Shorted in this set
⑧	CTS	
⑨	NC (not connected)	

These signal names are those of computer specifications.

Communication parameters

- Signal level: RS-232C compliant
- Synchronization method: Asynchronous
- Baud rate: 9600 bps
- Parity: None
- Character length: 8 bits
- Stop bit: 1 bit
- Flow control: None

Basic format for control data

The transmission of control data from the computer starts with a STX signal, followed by the command, the parameters, and lastly an ETX signal in that order. If there are no parameters, then the parameter signal does not need to be sent.

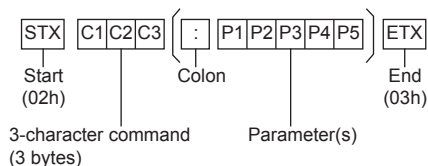

Command

Command	Parameter	Control details
PON	None	Power ON
POF	None	Power OFF
AVL	***	Volume 000 - 100
AMT	0	Audio MUTE OFF
	1	Audio MUTE ON
IMS	None	Input select (toggle)
	OP1	OpenPort PLATFORM input (OpenPort PLATFORM)
	HM1	HDMI 1 input (HDMI1)
	HM2	HDMI 2 input (HDMI2)
	DV1	DVI-D IN input (DVI-D)
	PC1	PC IN input (PC)
	VD1	VIDEO input (VIDEO)
	YP1	COMPONENT input (COMPONENT/RGB IN)
	UD1	USB input (USB)
DAM	None	Screen mode select (toggle)
	ZOOM	Zoom1
	FULL	16:9
	NORM	4:3
	ZOM2	Zoom2

Note

- If multiple commands are transmitted, be sure to wait for the response for the first command to come from this unit before sending the next command. When sending a command which does not require parameter, a colon (:) is not needed.
- If an incorrect command is sent by mistake, this unit will send an "ER401" command back to the computer.
- In Standby condition (power OFF with remote control), the unit responds to PON command only.
- Consult your local Panasonic dealer for detail instructions on command usage.

For more details, visit the following web site.
<http://panasonic.net/prodisplays/>

IR IN/IR OUT terminal connection

Connect the mini plug (M3) cable from the IR OUT terminal of the first display to the IR IN terminal of the second display.

The infrared signal of the first display is sent to the second display.

In this case, the IR (infrared ray reception on the remote control sensor) on the second display does not operate.

Repeating the above connections enables the daisy chain connection.

Note

- Connection cables are not supplied with this unit.
- Daisy chain connection is possible only between the displays of the same series.

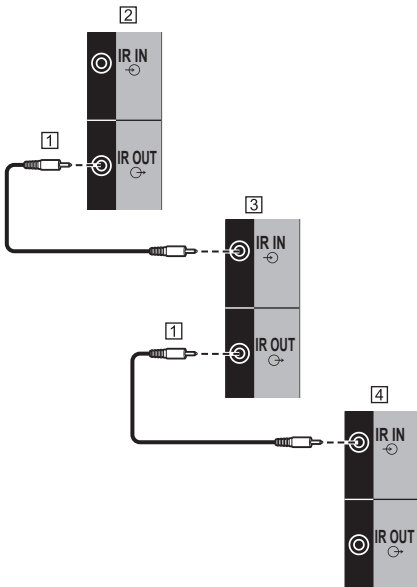

- 1 Stereo mini plug (M3) cable (commercially available)
- 2 First display
- 3 Second display
- 4 Third display

AUDIO OUT terminal connection

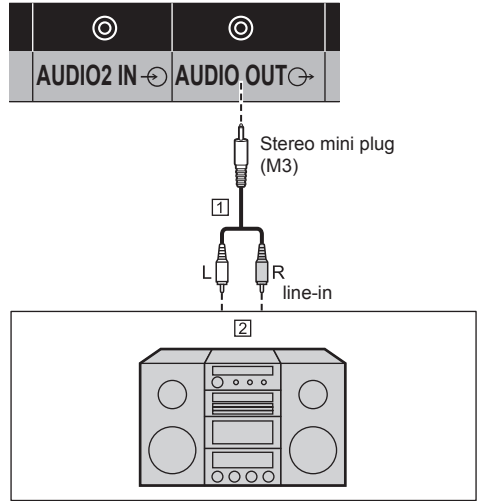

- 1 Stereo audio cable (commercially available)
- 2 Audio equipment

Note

- Audio equipment and the cable shown are not supplied with this set.
- To output sound from AUDIO OUT terminal of the unit, be sure to set [Output select] in the [Sound] menu to [AUDIO OUT]. (see page 70)

USB terminal connection

Connect the USB memory (commercially available) to use [USB media player]. (see page 103)

Also, power is supplied when a separately sold stick PC, etc. are connected.

Note

- A stick PC and connection cables are not supplied with this unit.

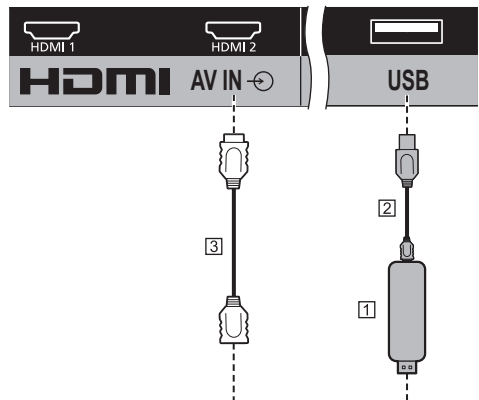

- ① Stick PC
- ② USB cable (commercially available)
- ③ HDMI extension cable (commercially available)

Pin assignments and signal names for USB Terminal

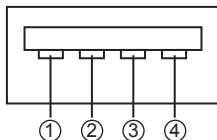

Pin No.	Signal name
①	+5 V DC
②	DATA -
③	DATA +
④	GND (Ground)

Power of up to 5V/1A can be supplied to an external device when the picture is displayed.

- If the electric current exceeding the power supplying capability is applied, the output is blocked, and the following message is displayed.

[USB DC5V OUT overload. Please remove cable or equipment, then turn the display off/on.]

In this case, remove the equipment and then turn the power off/on using the remote control, etc.

Note

- If the direct connection to this unit is not possible due to the size of a stick PC, etc. use a commercially sold extension cable.
- Depending on the type of a USB memory device, it may come in contact with the periphery such as a back cover, and cannot be attached. Use a commercially sold extension cable, or use a small type of a USB memory device connectable to this unit.
- Depending on the USB memory, the access lamp may remain blinking even when it is not being accessed. In this case, remove the device after switching to the input other than USB.

Also, when data cloning is running, remove the device after the screen to notify it is finished is displayed. (see page 107)

Using microSD card

By attaching a microSD card (commercially available) to the microSD card slot, use it as external storage for OpenPort PLATFORM system.

(see page 47)

■ microSD card usable on this unit

The following microSD card compliant with SD standard can be used on this unit.

(Such cards are referred to as microSD card in this manual.)

- microSD memory card (64 MB to 2 GB)
- microSDHC memory card (4 GB to 32 GB)

Only the Fat16-formatted microSD card and FAT32-formatted microSD card can be used on this unit.

■ To insert or remove the microSD card

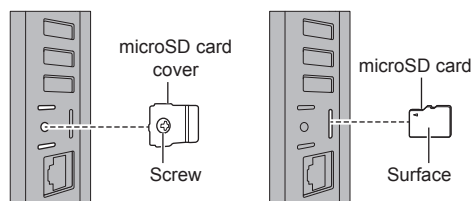

1 Using a driver, loosen the screw of the microSD card cover (anti-theft cover), and remove the cover.

2 Make the surface of the microSD card face back side of the unit, and insert it securely until a clicking sound is heard.

- For removal, push in the card until it clicks, and pull it out straight.

3 Attach the cover to the original position.

Note

- Do not touch the connection terminal of the microSD card.
- Before attaching or removing the microSD card cover, turn the unit off with <Main Power On / Off button>.
- Be careful not to lose the removed cover. Be sure to attach it to the original position.
- While the microSD card is operating, do not turn this unit off, pull out the microSD card, or subject this unit to vibration, shock or static electricity. Saved data, etc. may be lost, or malfunction may occur.
- When removing a microSD card, unmount the SD card. (see page 57)
- Do not insert non-standard microSD cards, or cards other than the microSD card. Malfunction may occur.

USB (OpenPort PLATFORM) terminal connection

By attaching a USB memory (commercially available) to the USB (OpenPort PLATFORM) terminal, use it as external storage for OpenPort PLATFORM system. (see page 47)

With OpenPort PLATFORM input, it is possible to connect and use USB devices such as a USB mouse, a USB keyboard, etc. (see page 43, 44)

Note

- USB memory, USB device and cable shown are not supplied with this unit.

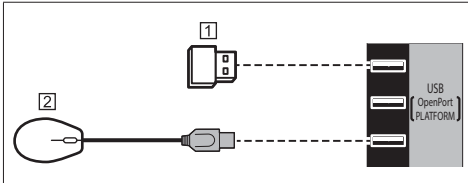

① USB memory

② USB mouse (commercially available)

Pin assignments and signal names for USB (OpenPort PLATFORM) Terminal

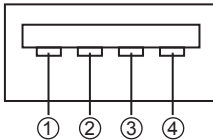

Pin No.	Signal Name
①	+5 V DC
②	DATA
③	DATA
④	GND (Ground)

Each USB (OpenPort PLATFORM) terminal is capable of supplying power of up to 5V/500mA to an external device when the picture is displayed or it is in standby condition (Power Indicator: Orange) (see page 32).

- If the electric current exceeding the power supplying capability is applied, the output is blocked, and the following message is displayed on the screen. (In standby condition, the message is displayed when the picture is displayed next time.)

[USB DC5V OUT overload (OpenPort PLATFORM). Please remove cable or equipment, then turn the display off/on.]

In this case, remove the connected equipment, and then turn the power off/on with the <Main Power On / Off button>.

■ About compatible USB memory

- Commercially available USB memory devices are compatible. (The ones with security function are not compatible.)
- Only the Fat16-formatted ones and FAT32-formatted ones can be used on this unit.
- The maximum memory size of USB is 32 GB.
- Only a single partition configuration is supported.

Note

- When removing a USB memory, unmount the USB memory. (see page 57)
- Depending on the type of a USB memory device, it may come in contact with the periphery such as a back cover, and cannot be attached. Use a commercially sold extension cable, or use a small type of a USB memory device connectable to this unit.
- If the direct connection to this unit is not possible due to the size of the USB device, use a commercially sold extension cable.

Micro-USB terminal connection

By connecting the unit to the PC using the Micro-USB cable, data in the storage of the OpenPort PLATFORM system can be read or written from the PC.

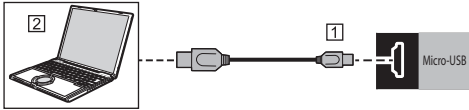

① Micro-USB cable (commercially available)

② PC

Pin assignments and signal names for Micro-USB Terminal

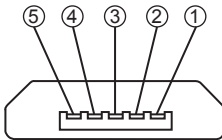

Pin No.	Signal Name
①	+5 V DC
②	DATA
③	DATA
④	ID
⑤	GND (Ground)

The Micro-USB terminal is capable of supplying power of up to 5V/500mA to an external device when the picture is displayed or it is in standby condition (Power Indicator: Orange) (see page 32).

- If the electric current exceeding the power supplying capability is applied, the output is blocked, and the following message is displayed on the screen. (In standby condition, the message is displayed when the picture is displayed next time.)

[USB DC5V OUT overload (OpenPort PLATFORM).
Please remove cable or equipment, then turn the display off/on.]

In this case, remove the connected equipment, and then turn the power off/on with the <Main Power On / Off button>.

Note

- Additional computer and cables shown are not supplied with this set.
- Insert or remove the Micro-USB cable slow and straight, avoiding excessive force.

Identifying Controls

Main unit

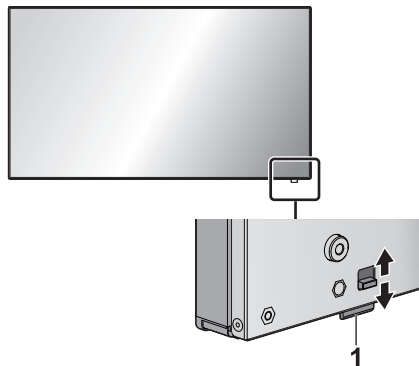

- To take out/store the power indicator and remote control sensor, operate the lever on the rear panel. It is also possible to press the remote control sensor directly to store.

Note

- For normal use, pull out the power indicator and remote control sensor from the edge side of the main unit by operating the lever on the rear panel. Depending on the setup condition such as when using the multi display, store them in the main unit.

1 Power Indicator / Remote control sensor

The Power Indicator will light.

When the power of the unit is ON (Main Power On / Off button: ON)

- Picture is displayed: Green
- Power OFF (standby) with remote control:
 - When [OpenPort PLATFORM standby] is set to [Off]: Red
 - When [OpenPort PLATFORM standby] is set to [On]: Orange (Red/Green)

About [OpenPort PLATFORM standby] settings, see page 83.

- Power OFF (sleep) with "Power management" function: Orange (Red/Green)
About "Power management" function, see page 81.

When the power of the unit is OFF (Main Power On / Off button: OFF): No light

Note

- Even if the display unit is turned off with the power indicator off, some of the circuits are in power-on status.
- When the power indicator is orange, power consumption during standby/sleep is generally larger than that of when the power indicator is red.
- When the power indicator is changing from green showing the picture is displayed to red or off, while the OpenPort PLATFORM system is shutting down, the indicator temporarily illuminates in orange. In this status, the remote control operation is ignored.
- When the <Main Power On / Off button> is pressed while the power indicator is lighting in orange (standby or sleep status), the power indicator blinks once, and then the shutdown processing of the OpenPort PLATFORM system (see page 40) is performed.
When the shutdown is complete, the power indicator goes off.

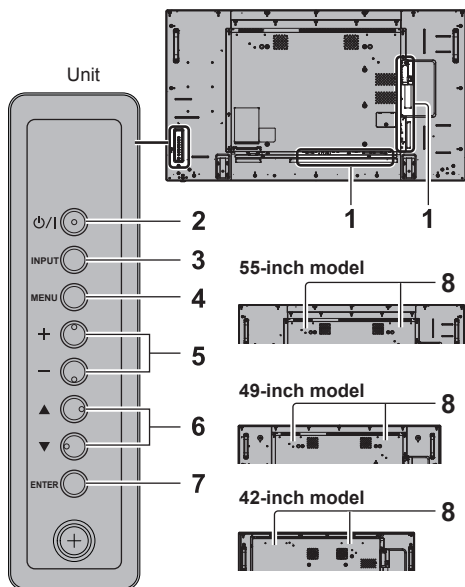

1 External Input Terminal

Connects to video equipment, PC, etc. (see page 19)

2 <Main Power On / Off button>

Turns the power On / Off.

3 <INPUT (Unit)>

Selects the connected device. (see page 37)

- In OpenPort PLATFORM operation mode
[EXIT]: Exits OpenPort PLATFORM operation mode and returns to the operation of the inputs other than OpenPort PLATFORM. (see page 42)

4 <MENU (Unit)>

Displays the menu screen. (see page 66)

- With OpenPort PLATFORM input
Switches to OpenPort PLATFORM operation mode. (see page 42)
- In OpenPort PLATFORM operation mode
[BACK]: Returns to the previous screen.
[HOME]: Press and hold to display the home screen. (see page 42)

5 <+ (Unit)> / <- (Unit)>

Adjusts the volume. (see page 38)

On the main screen, switches settings or adjusts settings level. (see page 66)

- In OpenPort PLATFORM operation mode
[RIGHT], [LEFT]:
Moves the cursor from side to side.
[KEYBOARD]:
Press and hold <- (Unit)> to display the software keyboard. (see page 42)

6 <▲ (Unit)> / <▼ (Unit)>

Selects the setting item on menu screen. (see page 66)

- In OpenPort PLATFORM operation mode
[UP], [DOWN]:
Moves the cursor up and down. (see page 42)

7 <ENTER (Unit)>

Configures the item on menu screen. (see page 66)
Switches aspect mode. (see page 64)

- In OpenPort PLATFORM operation mode
[ENTER]:
Configures the item.
[LONG PRESS ENTER]:
Used for the operation that requires long press. (see page 42)

8 Built-in speakers

- To output sound from the built-in speakers of the unit, be sure to set [Output select] in the [Sound] menu to [SPEAKERS]. (see page 70)

Note

- For more details on button operation of OpenPort PLATFORM, see page 42.

Remote Control Transmitter

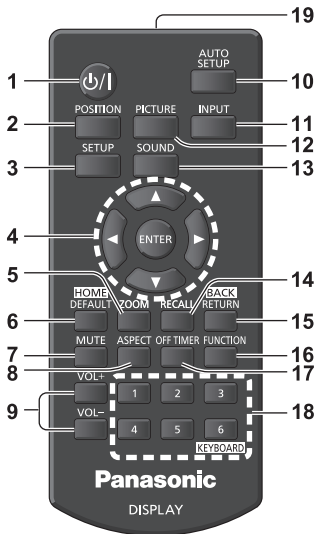

1 Standby (ON/OFF) button (⏻/⏻)

- Turns the power on or off when the Display is turned on at the <Main Power On / Off button>. (see page 35)

2 POSITION

(see page 68)

3 SETUP

(see page 78)

4 ENTER / Cursor buttons (▲▼◀▶)

- Used to operate the menu screens. (see page 66)
- With OpenPort PLATFORM input
Confirms the selected item, or move the cursor from right to left or up and down. (see page 41)

5 ZOOM

Enters the digital zoom mode. (see page 65)

6 DEFAULT/HOME

- Resets the settings of picture, sound, etc., to defaults. (see page 68, 70, 71)
- With OpenPort PLATFORM input
Displays the home screen. (see page 41)

7 MUTE

- Sound mute on / off. (see page 38)

8 ASPECT

- Adjusts the aspect. (see page 64)

9 VOL + / VOL -

- Adjusts sound volume level. (see page 38)

10 AUTO SETUP

- Automatically adjusts the position/size of the screen. (see page 68)

11 INPUT

- Switches input to display on the screen. (see page 37)

12 PICTURE

(see page 71)

13 SOUND

(see page 70)

14 RECALL

- Displays the current setting status of Input mode, Aspect mode, etc. (see page 38)

15 RETURN/BACK

- Used to return to the previous menu. (see page 66)
- With OpenPort PLATFORM input
Returns to the previous screen. (see page 41)

16 FUNCTION

- Displays [Function button guide]. (see page 86)

17 OFF TIMER

- Switches to stand-by after a fixed period. (see page 39)

18 Numeric buttons (1 - 6) / KEYBOARD

- Used as shortcut buttons by assigning frequently used operations. (see page 86)
- With OpenPort PLATFORM input
Press <KEYBOARD> to display the software keyboard. (see page 41)

19 Signal emission

Note

- In this manual, buttons of the remote control and the unit are indicated as <>.
(Example: <INPUT>.)

The operation is mainly explained indicating the remote control buttons but you can also operate with the buttons on the unit when there are the same buttons.

Basic Controls

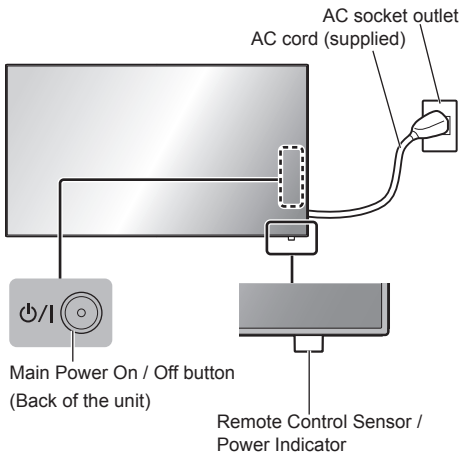

Operate pointing the remote control directly at the unit's Remote Control Sensor.



Note

- For normal use, pull out the remote control sensor from the edge side of the main unit by operating the lever on the rear panel. (see page 32)
- Do not put an obstacle between the remote control sensor of the main unit and the remote control.
- Operate the remote control in front of the remote control sensor or from the area where the sensor can be seen.
- When directly aiming the remote control at the remote control sensor of the main unit, the distance from the front of remote control sensor should be approx. 7 m or less. Depending on the angle, the operation distance may be shorter.
- Do not subject the remote control sensor of the main unit to the direct sunlight or strong fluorescent light.

1 Connect the AC cord plug to the Display.

(see page 18)

2 Connect the plug to the socket outlet.

Note

- Main plug types vary between countries. The power plug shown at left may, therefore, not be the type fitted to your set.
- When disconnecting the AC cord, be absolutely sure to disconnect the AC cord plug at the socket outlet first.
- The settings may not be saved if the power plug is disconnected immediately after changing settings with on-screen menu. Disconnect the power plug after a enough period of time. Or, disconnect the power plug after turning the power off with the remote control, RS-232C control or LAN control.

3 Press the <Main Power On / Off button> on the unit to turn the set on: Power-On.

- Power Indicator: Green (Picture is displayed.)
- When the power of the unit is ON, remote control operation is possible.

■ To turn the power ON/OFF with the remote control

Press the <Standby (ON/OFF) button> to turn the Display on.

- Power Indicator: Green (Picture is displayed.)

Press the <Standby (ON/OFF) button> to turn the Display off.

When [OpenPort PLATFORM standby] is set to [Off]

- Power Indicator: Red (standby)

When [OpenPort PLATFORM standby] is set to [On]

- Power Indicator: Orange (Red/Green) (standby)

(About [OpenPort PLATFORM standby] settings, see page 83.)

■ To turn the power OFF with the <Main Power On / Off button>

- When the power of the unit is ON (Picture is displayed: Power indicator in green):

Pressing the <Main Power On / Off button> will illuminate the power indicator in orange. When it goes off, the display unit turns off.

While the indicator is illuminating in orange, the remote control operation is ignored.

- When the power of the unit is ON (Standby/Sleep: Power indicator in orange):

Pressing the <Main Power On / Off button> will turn the power indicator off for a moment, and then illuminate it in orange. When it goes off, the display unit turns off.

While the indicator is illuminating in orange, the remote control operation is ignored.

- When the power of the unit is ON (Standby: Power indicator in red):

Pressing the <Main Power On / Off button> will turn the power indicator off and the display unit turns off.

Note

- During operation of the "Power management" function (see page 81), the power indicator turns orange in the power off (sleep) state.

■ **When the Unit is turned on for the first time**

Following screen will be displayed.

1 Select the language with ▲ ▼ and press <ENTER>.



2 For vertical installation, select [Portrait] with ▲ ▼ and press <ENTER>.

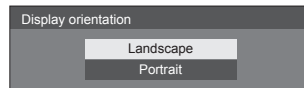

Note

- Once the items are set, the screens won't be displayed when switching on the unit next time. After the setting, the items can be changed in the following menus.

[OSD language] (see page 83)

[Display orientation] (see page 87)

- When [Display orientation] is set to [Portrait], a confirmation message to restart OpenPort PLATFORM is displayed.

■ Power ON message

The following message may be displayed when turning the unit power ON:

No activity power off Precautions

'No activity power off' is enabled.

When [No activity power off] in the [Setup] menu is set to [Enable], a warning message is displayed every time the power is turned ON. (see page 83)

Note

- [No activity power off] is not activated with OpenPort PLATFORM input. The message ['No activity power off' is enabled.] is not displayed, either.
- The message [Last turn off due to 'No activity power off'.] is also displayed when OpenPort PLATFORM input is used at the time the display is turned on.

"Power management" Information

Last turn off due to 'Power management'.

When "Power management" is functioned, an information message is displayed every time the power is turned ON. (see page 81)

These message displays can be set with the following menu:

- [Options] menu
Power on message(No activity power off)
(see page 96)
Power on message(Power management)
(see page 96)

Selecting the input signal

Select the signals input to the unit.

Press <INPUT> or <INPUT (Unit)>.

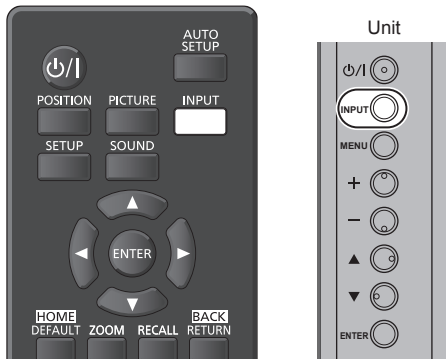

Switches input every time the buttons are pressed.

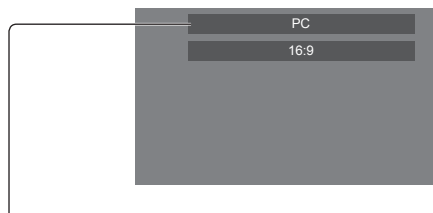

[OpenPort PLATFORM] → [HDMI1] → [HDMI2] → [DVI-D] → [PC] → [COMPONENT]* → [VIDEO] → [USB]

[OpenPort PLATFORM]:

OpenPort PLATFORM system built into this unit.

[HDMI1]:

HDMI 1 terminal, HDMI input

[HDMI2]:

HDMI 2 terminal, HDMI input

[DVI-D]:

DVI-D IN terminal, DVI-D input

[PC]:

PC IN terminal, PC input

[COMPONENT]*:

COMPONENT/RGB IN terminal, Component input

[VIDEO]:

VIDEO terminal, composite video input

[USB]:

USB terminal, USB input

*: [COMPONENT] may be displayed as [RGB] depending on the settings of [Component/RGB-in select]. (see page 78)

Note

- Displays the signal name as set in [Input label]. (see page 81)
- Input will not be switched unless [Input lock] is set to [Off]. (see page 93)
- Image retention (image lag) may occur on the LCD display panel when a still picture is kept on the panel for an extended period. To prevent such a problem, using the screensaver and wobbling is recommended. (see page 80, 83)

RECALL

It is possible to check the setting status of input label, picture mode, etc.

Press <RECALL>.

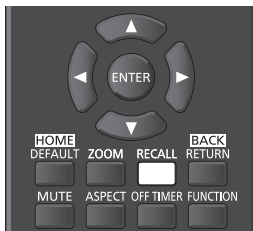

Current setting status will be displayed.

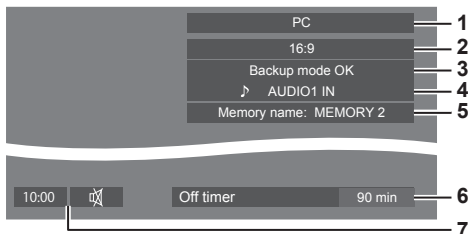

- 1 Input label
- 2 Aspect mode (see page 64)
- 3 Backup input change (see page 90)
- 4 Audio input (see page 92)
- 5 Profile name (see page 75)
- 6 Off timer remaining time (see page 39)
- 7 Clock / Mute (see page 38, 59)

- The followings are displayed for about 30 seconds at the end: [No signal] - when there is no video signal to the selected input, [No external media] - when a USB memory is not connected to the USB terminal at the time of using the USB input. During the OpenPort PLATFORM input, "no signal" is not discriminated.
- To display the clock, set [Date & time] in OpenPort PLATFORM, and then set [Clock display] to [On]. (see page 59, 95)

Volume Adjustment

Press <VOL +> <VOL -> or <+ (Unit)> <- (Unit)> to adjust volume.

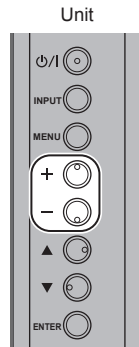

- The current sound volume level is memorised even if the power is turned off.
- When [Maximum VOL level] is set to [On], the volume can only be adjusted to the maximum point you set, and the displayed value turns red when it reached its maximum. (see page 93)
- When [Initial VOL level] is set to [On], the volume will be at the set level when the display is turned on. (see page 92)

Sound mute On / Off

It is useful when you want to mute the sound temporarily, for example, when answering the phone or door.

Press <MUTE>.

- appears on the screen and the sound is muted. Press again to reactivate the sound.



- It is also reactivated when the power is turned on / off or the volume level is changed.
- While MUTE is active, is displayed as a reminder after operation.
- In [ENGLISH(US)] OSD language, is displayed as [MUTE].

OFF TIMER

The Display can be preset to switch to stand-by after a fixed period. (30 min, 60 min, 90 min)

The **setting switches each time <OFF TIMER> is pressed.**

- [0 min] → [30 min] → [60 min] → [90 min]
→ [0 min] (Cancel)



- When three minutes remain, the remaining time will flash (Red). After that, it switches to stand-by.
- To see the Off timer remaining time, press <RECALL>.

The Off timer is cancelled if a power interruption occurs. When the power is turned on later on, it will be in stand-by condition.

Startup of OpenPort PLATFORM

This unit is equipped with the OpenPort PLATFORM system based on Android.

Set the input select to OpenPort PLATFORM for using. (see page 37)

Startup

The startup processing of the OpenPort PLATFORM system is performed when the unit starts up while the power indicator is off (power-off status) or lighting in red (standby status).

The startup screen appears while the unit is starting up in the OpenPort PLATFORM input selection status.



Note

- Approx. 40 seconds for startup. When starting up for the first time, approx. 70 seconds are taken.
- When [Options] - [Startup logo] is set to [On], this is displayed followed by the Panasonic logo. (see page 94)
- When the power indicator is lighting in orange (standby or sleep status), the OpenPort PLATFORM system is operating. When the unit starts up in this status, the startup screen does not appear.
- When OpenPort PLATFORM cannot respond for some reason, it is restarted automatically and then the recovery processing is performed.

Shutdown

The shutdown processing of the OpenPort PLATFORM system is performed either when the power is turned off using the <Main Power On / Off button> or the power is turned off using the remote control, etc. when [Setup] - [OpenPort PLATFORM standby] is set to [Off] (see page 83).

During shutdown process, the power indicator lights up in orange from green illumination, the message [Shutting down OpenPort PLATFORM. Please wait.] appears.

Note

- Approx. 30 seconds for shutdown.
- While the OpenPort PLATFORM system is shutting down, the remote control operation or external control commands are not accepted.
- When the unit is in standby status (Power Indicator: Red) by shutting down the OpenPort PLATFORM system, the wired LAN or wireless LAN networks are cut, and the power can be turned on only by the following operations. (The power cannot be turned on by [Setup] - [Set up timer] as well. (see page 85))
 - Power-on by the power button of remote control
 - "PON" command reception from the SERIAL terminal

Forcibly shutting down the OpenPort PLATFORM system

[TOOLS] - [Shutdown] (see page 61)

[OpenPort PLATFORM Shutdown] (see page 112)

Basic Operation/Character Input for OpenPort PLATFORM

Remote Control Transmitter

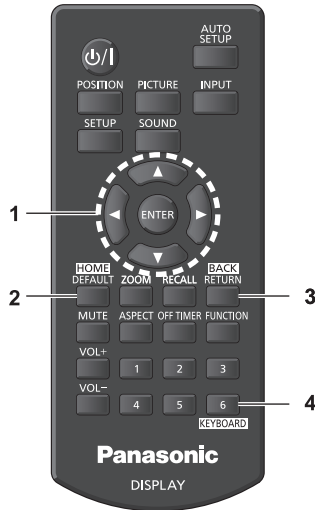

The following remote control buttons are designed for the OpenPort PLATFORM operation.

1 <ENTER> / Cursor buttons

- Confirms the selected item, or move the cursor (focus) from right to left or up and down.

*Icons or items may be focused only after operating the buttons.

2 <HOME>

- Displays the home screen.

3 <BACK>

- Returns to the previous screen.

4 <KEYBOARD>

- Shows or hides the software keyboard.

Note

- For button operations other than OpenPort PLATFORM operation, see page 34.
- The remote control operation designed for the OpenPort PLATFORM operation is not available while the on-screen display is displayed. Operate after hiding the on-screen display, or after it is disappeared.
- Some applications cannot be operated using the remote control. In this case, use a USB mouse (commercially available) for operation. (see page 43)

Buttons on the main unit

■ OpenPort PLATFORM operation mode

Using the main unit buttons instead of the remote control can operate OpenPort PLATFORM.

1 When using the OpenPort PLATFORM input, press <MENU (Unit)>.

The following screen appears.

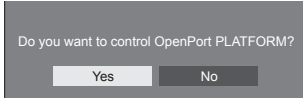

2 Select [Yes] with <+ (Unit)> <- (Unit)> and press <ENTER>.

Enters the OpenPort PLATFORM operation mode. The operation guide of the main unit button is displayed.

The operation guide disappears by exiting the OpenPort PLATFORM operation mode.

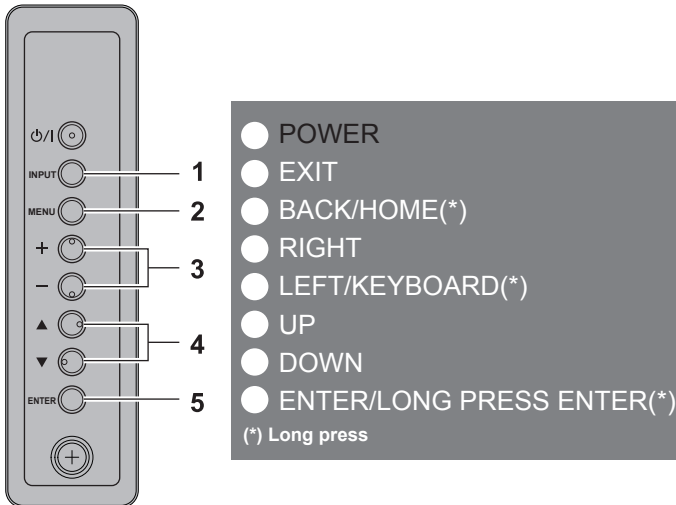

1 <INPUT (Unit)>

[EXIT]: Exits OpenPort PLATFORM operation mode and returns to the operation of the inputs other than OpenPort PLATFORM.

2 <MENU (Unit)>

[BACK]: Returns to the previous screen.

[HOME(*)]: Press and hold to display the home screen.

3 <+ (Unit)> <- (Unit)>

[RIGHT], [LEFT]: Moves the cursor (focus) from side to side.

[KEYBOARD(*)]: Press and hold <- (Unit)> to display the software keyboard. While it is displayed, press and hold <- (Unit)> to hide.

4 <▲ (Unit)> <▼ (Unit)>

[UP], [DOWN]: Moves the cursor (focus) up and down.

5 <ENTER (Unit)>

[ENTER]: Configures the item.

[LONG PRESS ENTER(*)]: Used for the operation that requires long press.

* The (*) mark for operation guides shows the long press operation.

USB mouse

A USB mouse (commercially available) can perform the OpenPort PLATFORM operation.

- Connect the USB mouse to the USB (OpenPort PLATFORM) terminal.
- The USB mouse can perform the swipe or drag operation that cannot be performed using the remote control.
- Some applications cannot be operated using the remote control. In this case, use a USB mouse.
- When an optical mouse is used, its movement may not be reflected properly, depending on the accuracy of reading.

Software keyboard

Use the software keyboard when inputting characters for OpenPort PLATFORM.

For displaying or hiding the software keyboard: see page 41, 42

■ [OpenPort keyboard]

This is the OpenPort PLATFORM-unique software keyboard.

Example: Alphabet input (lowercase character)

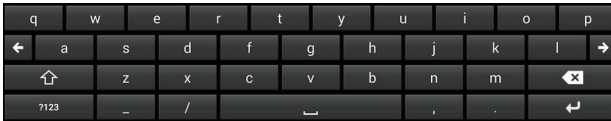

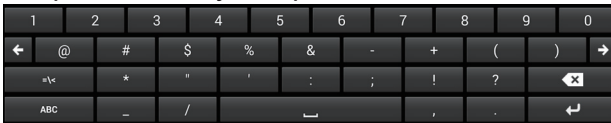

Example: Number and symbol input



Example: Mathematical symbol and currency symbol input



- Compatible with the input of alphanumeric characters and symbols.
- Candidates for words are not displayed.
- Use the cursor button or <ENTER> button of the remote control for operation.
A USB mouse (commercially available) can also be used.
- The selected key is enlarged for display.
- The input position can be moved from side to side with  .

Switching the input characters



Switches between the uppercase and the lowercase of alphabet input.



Switches to the number and symbol input from the alphabet input or from the mathematical symbol and currency symbol input.



Switches to the mathematical symbol and currency symbol input from the number and symbol input.



Switches to the alphabet input from the number and symbol input or from the mathematical symbol and currency symbol input.

Changing the software keyboard

The software keyboard can be changed from [OpenPort keyboard] to [Android Keyboard (AOSP)] in [SETUP] (or [TOOLS] - [Settings]) - [Language & input]. (see page 58)

■ [Android Keyboard (AOSP)]

This is the Android standard software keyboard.

Example: Alphabet input



- Compatible with the multi-lingual input.
- Candidates for words are displayed. (May not be displayed with some applications.)
- The remote control operation is not possible. Use a USB mouse for operation.
- Depending on the application, a keyboard designed for inputting numbers may be displayed.

USB keyboard

A USB keyboard (commercially available) instead of software keyboard can be used for the character input of OpenPort PLATFORM.

- Connect the USB keyboard to the USB (OpenPort PLATFORM) terminal.
- Depending on the keyboard, some key operations are invalid.
- Setting the keyboard layout (for each language): [SETUP] (or [TOOLS] - [Settings]) - [Language & input] (see page 58)

Operation icon

When operating (such as clicking on the screen) with a USB mouse (commercially available), the following operation icons are displayed.



Click the USB mouse for operation. These operation icons cannot be selected or operated using the remote control.

[BACK]: Returns to the previous screen. (Same operation as with the <BACK> button of the remote control)

[HOME]: Displays the home screen. (Same operation as with the <HOME> button of the remote control)

[RECENT APPS]: Displays the screen (Android standard screen) of the application recently used. (see page 63)

Note

- When the operation icons are not displayed, they will be displayed by swiping the screen from the bottom edge to the top with a mouse.

Home Screen of OpenPort PLATFORM

When OpenPort PLATFORM starts up, the home screen is displayed at first.

6 button icons are displayed on the home screen.

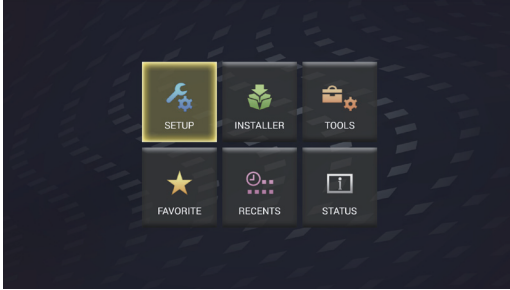

Select the icon with cursor buttons on the remote control and press <ENTER>.

Moves to the screen of the selected icon.

- [SETUP]:** Set [WIRELESS & NETWORKS], [Language & input] and [Date & time settings]. (see page 46)
- [INSTALLER]:** Use this when installing a new application. (see page 47)
- [TOOLS]:** Pre-installed applications for various setups are collected here. Each application can be started up from here. (see page 49)
- [FAVORITE]:** Register your favourite applications and start them up from here. (see page 49)
- [RECENTS]:** Recently used applications are displayed. Each application can be started up from here. (see page 51)
- [STATUS]:** The model information of this unit and network-related setting information can be confirmed. (see page 52)

Note

- As factory default, the home screen is set to this unit unique [QuickLauncher] screen. It is also possible to switch to the Android standard, [Launcher] screen. (see page 57)
- It is recommended selecting [QuickLauncher] for this unit.
- In this manual, explanations are mainly based on the case where [QuickLauncher] is selected.
- If an application such as signage player starting up automatically has been set at the startup of OpenPort PLATFORM, the screen of the application is displayed. (see page 60)

[SETUP] screen of OpenPort PLATFORM

Select the [SETUP] button icon on the home screen to display the [SETUP] application screen.

Set [WIRELESS & NETWORKS], [Language & input] and [Date & time settings].

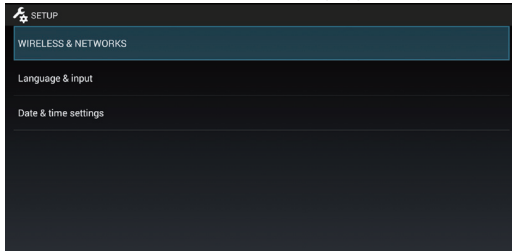

Select the item with ▲ ▼ and press <ENTER>.

Switches to the setting screen of the selected item.

Returns to the [SETUP] screen with <BACK>.

- [WIRELESS & NETWORKS]:** Make various settings for network.
It is also possible to set in [TOOLS] - [Settings] - [WIRELESS & NETWORKS]. (see page 55)
Make this setting before using the network.
- [Language & input]:** Sets the language to use, input method, etc.
It is also possible to set in [TOOLS] - [Settings] - [Language & input]. (see page 58)
- [Date & time settings]:** Sets the date and time.
It is also possible to set in [TOOLS] - [Settings] - [Date & time]. (see page 59)

Note

- If connected to the network, the date and time can be automatically set. However, it will be required to set the time zone. Set manually. (see page 59)
- If not connected to the network, set the date and time manually. (Use a USB mouse for setting.)
- If the clock shows wrong time soon after set to the right time, replace the battery inside the unit. Consult the dealer where you purchased the product.
- In the network condition where both the wired LAN and wireless LAN operate, the wired LAN is prioritized for operation. When using the wireless LAN, disconnect the wired LAN cable.

[INSTALLER] screen of OpenPort PLATFORM

Select the [INSTALLER] button icon on the home screen to display the [INSTALLER] application screen. Use this when installing a new application.

■ Installing the application from the external storage (microSD card, USB memory (USB (OpenPort PLATFORM) terminal))

Searches the external storage for the installation file of the application, and displays it on the list.

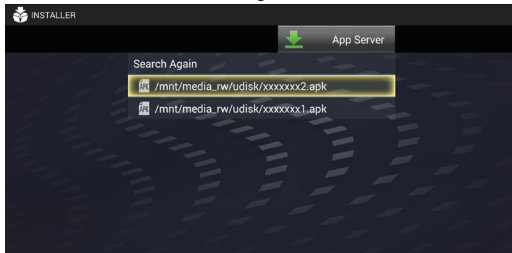

Select the installation file from the displayed list, and press <ENTER>.

Starts to install the application.

Depending on the application, the message [Install blocked] appears, and the installation may not be performed. In this case, the installation is possible by [All installation of apps from unknown sources]. Add a check mark for [Unknown sources].

[TOOLS] - [Settings] - [Security] (see page 58)

- When the application list is not displayed, select the [Search Again] button and press <ENTER>.

■ Installing the application from the application server

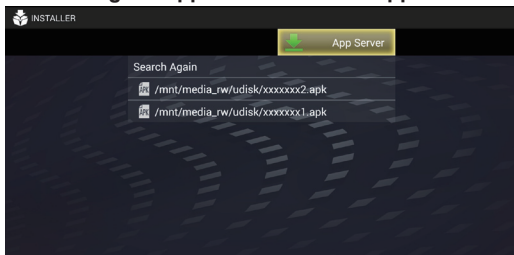

1 Select [App Server] and press <ENTER>.

Connects to the application server, and displays the application list screen.

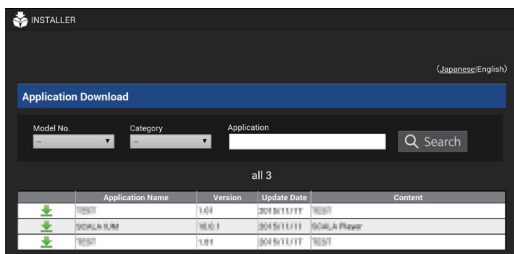

2 Select the application to download and press <ENTER>.

It is possible to search and refine applications in accordance with the model number (the model number of this unit is set automatically), category and application name.

Automatically starts to install the application after downloading is complete. Follow the displayed instructions to perform the installation.

Note

- Design of the download screen is subject to change.

[TOOLS] screen of OpenPort PLATFORM

Select the [TOOLS] button icon on the home screen to display the [TOOLS] screen.

Various setting-related applications pre-installed are collectively displayed with icons.

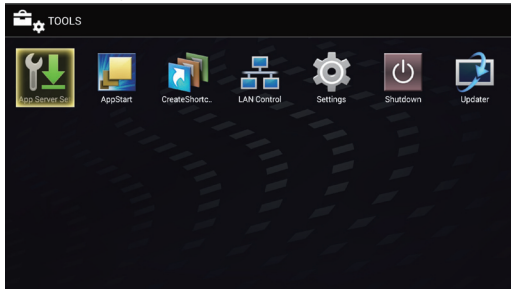

Select the application to start up, and press <ENTER>.

The application starts up. For details of each application, see the following pages.

[App Server Setting] application	(see page 61)
[AppStart] application	(see page 60)
[CreateShortcut] application	(see page 60)
[LAN Control] application	(see page 54)
[Settings] application	(see page 55)
[Shutdown] application	(see page 61)
[Updater] application	(see page 61)

[FAVORITE] screen of OpenPort PLATFORM

Select the [FAVORITE] button icon on the home screen to display the [FAVORITE] screen.

The applications registered as [FAVORITE] are displayed with icons.

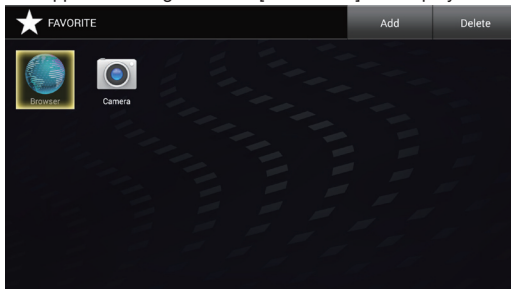

Select the application to start up, and press <ENTER>.

The application starts up.

As factory default, the following applications are registered as [FAVORITE].

[Browser] application	(see page 62)
[Camera] application	(see page 62)

Adding the application to [FAVORITE]

Adds the installed application to [FAVORITE].

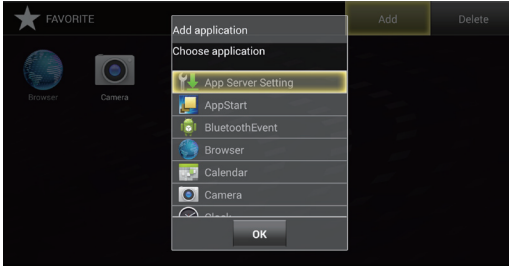

1 Select [Add] and press <ENTER>.

Displays the [Add application] dialogue.

2 Select the application to add and press <ENTER>.

Adds the selected application. Multiple applications can be selected in a row.

3 Select [OK] and press <ENTER>.

The dialogue is closed.

It is also possible to close the dialogue by pressing <BACK>.

Note

- Installing the application will automatically add the application to [FAVORITE].
- The shortcut (see page 60) is also added to [FAVORITE].

Deleting the application from [FAVORITE]

Deletes the application from [FAVORITE].

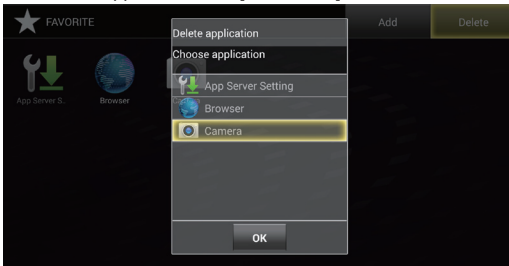

1 Select [Delete] and press <ENTER>.

Displays the [Delete application] dialogue.

2 Select the application to delete and press <ENTER>.

Deletes the selected application. Multiple applications can be selected in a row.

3 Select [OK] and press <ENTER>.

The dialogue is closed.

It is also possible to close the dialogue by pressing <BACK>.

Note

- The deleted application only disappears from [FAVORITE], and can be added again with [Add].
- The shortcut (see page 60) can also be deleted. The deleted shortcut cannot be added to [FAVORITE] again by selecting [Add].

[RECENTS] screen of OpenPort PLATFORM

Select the [RECENTS] button icon on the home screen to display the [RECENTS] screen.

The recently used applications are displayed with icons.

When the OpenPort PLATFORM system is shut down (see page 40), the history is cleared.

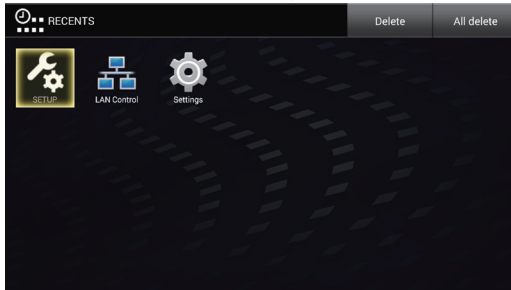

Select the application to start up, and press <ENTER>.

The application starts up.

Deleting the application from [RECENTS]

Deletes the application from [RECENTS].

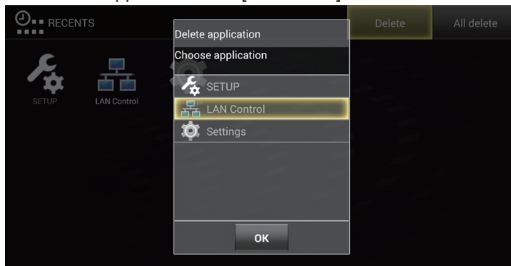

1 Select [Delete] and press <ENTER>.

Displays the [Delete application] dialogue.

2 Select the application to delete and press <ENTER>.

Deletes the selected application. Multiple applications can be selected in a row.

3 Select [OK] and press <ENTER>.

The dialogue is closed.

It is also possible to close the dialogue by pressing <BACK>.

■ **Deleting all the applications from [RECENTS]**

Select the [All Delete] button, and press <ENTER>.

Deletes all the applications for [RECENTS], and moves to the home screen.

[STATUS] screen of OpenPort PLATFORM

Select the [STATUS] button icon on the home screen to display the [STATUS] application screen.

The model information and network-related setting information of this unit can be confirmed.

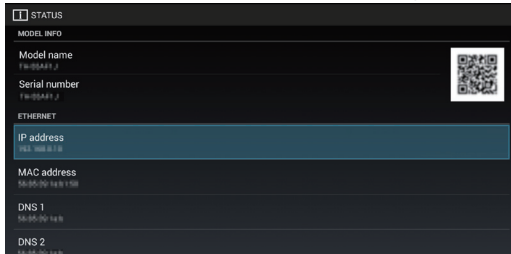

Scroll the screen to display the following information.

■ [MODEL INFO]

[Model name]
[Serial number]
QR code
([Model name], [Serial number],
[MAC address] of [ETHERNET])

Note

- Data of QR code can be read by taking the picture using a camera of mobile phone, etc. The reading quality is affected by the performance of camera or application.

■ [SUPPORT]

Select [Check Communication] or [Log].

[Check Communication]

Select [ping], [nslookup] or [traceroute] to perform.

- [ping]:** Input the IP address to [Host], and select [Execute]. Then, the response from the sender is displayed.
- [nslookup]:** Input the address name to [Host], and select [Execute]. Then, you can check if the DNS problem is solved.
- [traceroute]:** Input the address name to [Host], and select [Execute]. Then, the network path to the specified Host is displayed.

[Log]

Saves log to a USB memory (USB (OpenPort PLATFORM) terminal).

This is a function for the technical support.

■ [ETHERNET]

[IP address]
[MAC address]
[DNS 1]
[DNS 2]
[IP settings]
[Proxy hostname]
[Proxy port]
[DHCP]

■ [WI-FI]

[IP address]
[MAC address]
[DNS 1]
[DNS 2]
[IP settings]
[Proxy hostname]
[Proxy port]
[DHCP]

Pre-installed Applications of OpenPort PLATFORM

Pre-installed application list

Application name	Location	Type	Description
SETUP	Home	Panasonic* ²	Sets [WIRELESS & NETWORKS], [Language & input] and [Date & time settings]. (Same as a part of [TOOLS] - [Settings]) (see page 46)
INSTALLER	Home	Panasonic* ²	Use this when installing a new application. (see page 47)
STATUS	Home	Panasonic* ²	The model information of this unit and network-related setting information can be confirmed. (see page 52)
LAN Control	TOOLS	Panasonic* ²	Sets [ON]/[OFF] of [Command Control], [Control Protocol], [Port number], [Display name], [User name] and [Password] via LAN of this unit. (see page 54)
Settings	TOOLS	Android* ³	Makes various settings for Android OS. (see page 55)
CreateShortcut	TOOLS	Panasonic* ²	Creates shortcuts to access specified URLs by browser. (see page 60)
AppStart	TOOLS	Panasonic* ²	Specifies the URL (browser) or application to launch first when the OpenPort PLATFORM system starts up. (see page 60)
App Server Setting	TOOLS	Panasonic* ²	Makes the setting to link with the application server. (see page 61)
Shutdown	TOOLS	Panasonic* ²	Forcibly shuts down the OpenPort PLATFORM system. (see page 61)
Updater	TOOLS	Panasonic* ²	Use this when updating the firmware of the OpenPort PLATFORM system of this unit. (see page 61)
SignageBrowser	*1	Panasonic* ²	This is a WEB browser compatible with HTML5 customized for signage use. (see page 61)
Version	*1	Panasonic* ²	Displays the uboot version, kernel version and system version of the OpenPort PLATFORM system firmware of this unit. (see page 62)
Browser	FAVORITE (Factory default)	Android* ³	Displays WEB pages for browsing. (see page 62)
Camera	FAVORITE (Factory default)	Android* ³	Connect a USB camera (commercially available) to the USB (OpenPort PLATFORM) terminal for using. (see page 62)
Clock	*1	Android* ³	Displays clock, set alarm, etc.
Downloads	*1	Android* ³	Displays the list of the files which have been downloaded from WEB sites.
Gallery	*1	Android* ³	Displays still picture or motion picture for browsing.
Music	*1	Android* ³	Plays back music.
People	*1	Android* ³	Manages contacts.
Search	*1	Android* ³	Used for searching.
Sound Recorder	*1	Android* ³	Records sounds.
Calendar	—	Android* ³	Internal application. No need to start up.
BluetoothEvent	—	Android* ³	Internal application. No need to start up.

*1 Register to [FAVORITE] for using. (see page 50)

*2 This unit unique application.

*3 Android standard, AOSP (Android Open Source Project) application

Note

- Some applications cannot be operated with the remote control. In this case, use a USB mouse (commercially available). (see page 43)

[LAN Control] application

This unit unique application. Select the [LAN Control] button icon on the [TOOLS] screen to display the [LAN Control] screen.

Sets [ON]/[OFF] of [Command Control], [Control Protocol], [Port number], [Display name], [User name] and [Password] via LAN of this unit.

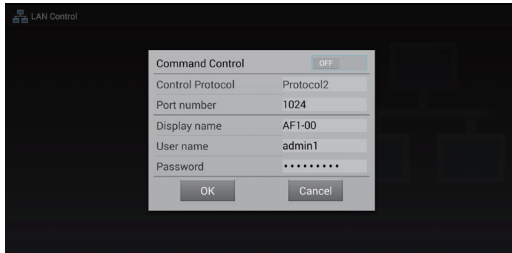

■ [Command Control]

Set this to [ON] when performing the command control of this unit (see page 98) via network.

[ON]: Enables the command control.

[OFF]: Disables the command control.

■ [Control Protocol]

Select the protocol for the LAN control.

[Protocol1]: Controls with the sequence of the Panasonic display.

[Protocol2]: Controls with the sequence compatible with the Panasonic projector.

Note

- PJLink can be operated regardless of the [Control Protocol] setting.
- When performing the command control with TCP/IP, select [Protocol1].
- When operating the “Early Warning Software” or “Multi Monitoring & Control Software”, select [Protocol2].

■ [Port number]

Set the port number to use for the command control.

Setting range: 1024 (Default) to 65535 (excluding 4352)

Note

- When using PJLink, the port setting is not necessary.

■ [Display name]

Set the name of this unit displayed on the network.

■ [User name]

Set the user name added to the command.

(Default: admin1)

■ [Password]

Set the password used for the command control and PJLink security authentication.

(Default: panasonic)

[Settings] application

Android standard application. Select the [Settings] button icon on the [TOOLS] screen to display the [Settings] screen.

Note

- Some functions are not available on this unit.

Make various settings for Android OS.

Select the setting item and press <ENTER> to display the setting screen.

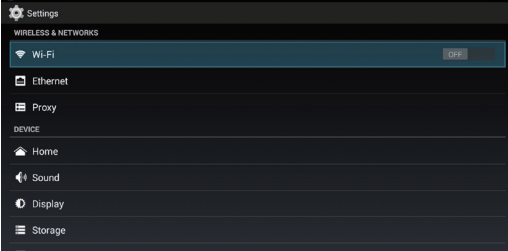

Scroll the screen to display the following items.

■ [WIRELESS & NETWORKS]

Make various settings for network.

This can be set by selecting [SETUP] - [WIRELESS & NETWORKS] as well. (see page 46)

[Wi-Fi]

To enable the Wi-Fi function, set the [OFF/ON] button to [ON].

The access point list in your area is displayed. Selecting the connection destination displays the security password setting dialogue.

[Password]:	Enter the password.
[Show password]:	Displays the input password when a check mark is added to the check box.
[Show advanced options]:	Displays [Proxy] and [IP settings] when a check mark is added to the check box.
[Connect]:	Connects to the selected access point.
[Cancel]:	Cancels the connection, and returns to the access point list display.

[Proxy]:

[None]:	The proxy is not set.
[Manual]:	The proxy is set manually.

[Proxy hostname]:	Sets the host name of proxy.
[Proxy port]:	Sets the port number of proxy.
[Bypass proxy for]:	Sets the domain that does not use the proxy.

[IP settings]:

[DHCP]:	Acquires the IP address automatically if a DHCP server is present on the network where the display is connected.
[Static]:	Sets the IP address manually if a DHCP server is not present on the network where the display is connected.

[IP address]:	Sets the IP address if a DHCP server is not used.
[Gateway]:	Sets the gateway address if a DHCP server is not used.
[Network prefix length]:	Sets the network prefix length if a DHCP server is not used.
[DNS 1]:	Sets the priority DNS server address if a DHCP server is not used.
[DNS 2]:	Sets the substitute DNS server address if a DHCP server is not used.

[WPS Push Button]

Use this when connecting to the access point device compatible with WPS.

Selecting [WPS Push Button] will make the access point device enter the WPS button standby mode.

For operation of the access point device, read the operating instructions supplied with the device.

+ button

Adds the access point.

If the access point you wish to connect cannot be found on the list, set the following with manual input.

Selecting + button will display the setting menu of the network to add.

[Network SSID]: Enter the SSID.

[Security]: Select the encryption method from the following.
[None], [WEP], [WPA/WPA2 PSK], [802.1x EAP]

[Show advanced options]: Displays [Proxy] and [IP settings] when a check mark is added to the check box.

Menu button

Select the menu button to display the following items.

[Scan]: Searches for access points in your area again, and displays them on the list.

[WPS Pin Entry]: Use this when connecting to the access point device compatible with WPS.
A PIN code is displayed in the message displayed when this is selected. Input the PIN code into the access point device within 2 minutes.

For operation of the access point device, read the operating instructions supplied with the device.

[Wi-Fi Direct]: Directly communicates between Wi-Fi devices without the access point device.

Selecting this will display usable devices on the list. Select the device to connect.
Displays the option settings related to Wi-Fi communication.

[Advanced]:

Note

- When [IP settings] is set to [DHCP], the IP address, etc. are not displayed. Confirm the current IP address, etc. in [STATUS]. Also, the DNS set on this screen will be invalid.
- When using a DHCP server, confirm that the DHCP server has started up.
- For setting details, consult the network administrator.
- The wired LAN and wireless LAN cannot be used in the same segment.

[Ethernet]

[DHCP]

- [ON]:** Acquires the IP address automatically if a DHCP server is present on the network where the display is connected.
- [OFF]:** Sets the IP address manually if a DHCP server is not present on the network where the display is connected.

- [IP address]:** Input the IP address if not using a DHCP server.
- [Gateway]:** Input the gateway address if not using a DHCP server.
- [Subnet mask]:** Input the subnet mask if not using a DHCP server.
- [DNS 1]:** Input the priority DNS server address if not using a DHCP server.
- [DNS 2]:** Input the substitute DNS server address if not using a DHCP server.
- [OK]:** Saves the setting, and returns to the [Settings] screen.
- [Cancel]:** Returns to the [Settings] screen without saving the setting.

Note

- When [DHCP] is set to [ON], items for the IP address, gateway, subnet mask and DNS are greyed out.
- When using a DHCP server, confirm that the DHCP server has started up.
- If an invalid IP address, gateway or subnet mask is set, selecting [OK] will display the following error message.
[INVALID ENTRY. PLEASE RE-ENTER.]
- If the IP address is conflicting, selecting [STATUS] - [ETHERNET] - [IP address] (see page 52) will display the following error message.
[IP address conflict with another system on the network.]
- For setting details, consult the network administrator.
- The wired LAN and wireless LAN cannot be used in the same segment.

[Proxy]

- [Proxy hostname]:** Sets the host name of proxy.
- [Proxy port]:** Sets the port number of proxy.
- [Bypass proxy for]:** Sets the domain that does not use the proxy.
- [OK]:** Saves the setting, and returns to the [Settings] screen.
- [Cancel]:** Returns to the [Settings] screen without saving the setting.

Note

- For setting details, consult the network administrator.

■ [DEVICE]

[Home]

Sets the home screen. Use a USB mouse for setting.

[Launcher]: Android standard home screen (see page 63)

[QuickLauncher]:

Recommended home screen for this unit (Factory default) (see page 45)

[Sound]

Sets the touch operation sound when using a USB mouse.

[Touch sounds]: Add a check mark for the check box to enable the touch operation sound.

[Display]

Select the setting item and press <ENTER> to display the setting screen.

[Wallpaper]

Select a wallpaper from the following 3 items.

[Gallery]: Select a wallpaper from image files in [Gallery].

[Live

Wallpaper]:

[Wallpaper]: Select a wallpaper of still picture.

Note

- The wallpaper is displayed only on the Android standard home screen, etc.

[Daydream] (This function cannot be used.)

[Font size]

Select the character size from the following 4 types.

[Small], [Normal], [Large], [Huge]

[Cancel]: Returns to the [Display] function list screen without saving the setting.

[Storage]

Displays the current storage usage ([INTERNAL STORAGE], microSD card, [USB STORAGE]).

[INTERNAL STORAGE]

[SD CARD]

When removing the microSD card, unmount it here for safe removal.

[USB STORAGE]

When removing the USB memory, unmount it here for safe removal.

Note

- When attaching or removing a microSD card or a USB memory, an SD card shaped icon or warning messages will be displayed at the upper left of the screen. As a general term, they are called "SD card" in the message.
- As for USB memory, it is also called "SD card" even though it is displayed in [USB STORAGE] category.

[Apps]

Displays the application list. Operate right and left, and select the list from the following 3 items.

[DOWNLOADED]: Already installed application list

[RUNNING]: Operating application list

[ALL]: All application list

Stops, disables and deletes the application.

Uninstallation is possible only for installed applications.

■ [PERSONAL]

[Location]

To enable the function to acquire location information, set the [OFF/ON] button to [ON].

[Mode] (This function is only available with Wi-Fi.)

[Security]

Makes the security-related settings.

[SCREEN SECURITY]

[Screen lock]:

Selects the screen lock method.

Once the screen lock is set, you will need to unlock it when performing [Factory data reset].

[Owner info]: (This function cannot be used.)

[ENCRYPTION] (This function cannot be used.)

[PASSWORDS] (This function cannot be used.)

[DEVICE ADMINISTRATION]

[Device administrators]: (This function cannot be used.)

[Unknown sources]:

Permits installation of unknown applications when a check mark is added to the check box.

[Verify apps]: (This function cannot be used.)

[CREDENTIAL STORAGE]

[Storage type]:

Software only

[Trusted credentials]:

Displays the reliable CA certificate.

[Install from SD card]:

Installs the certificate from the microSD card and USB memory.

[Clear credentials]:

Deletes all the certificates.

[Language & input]

Sets the language to use, input method, etc.

This can be set by selecting [SETUP] - [Language & input] as well. (see page 46)

Select the setting item and press <ENTER> to display the setting screen.

[Language]

Select the language to use from the language list.

Selectable languages

[Deutsch]: German

[English (United Kingdom)]: English (UK)

[English (United States)]: English (US)

[Español]: Spanish

[Français]: French

[Italiano]: Italian

[Русский]: Russian

[中文]: Chinese

[日本語]: Japanese

Note

- This is set while interlocking [Setup] - [OSD language]. (see page 83)

[Spell checker]

Select whether to use the spell check during character input.

[Personal dictionary]

Displays the user dictionary list. Select the user dictionary to register.

Select the [ADD] button to display the word registration screen. Then, register the word.

[KEYBOARD & INPUT METHODS]

When [Default] is selected, [Choose input method] screen is displayed. Select the input method.

[Android Keyboard (AOSP)]:

Android standard software keyboard.

[OpenPort keyboard]

OpenPort PLATFORM-unique software keyboard.

Note

- Connecting a USB keyboard will display the setting items of physical keyboard. Select the connected keyboard here to display the [Choose keyboard layout] screen.

Select [Set up keyboard layouts], set language in [Keyboard layouts] to complete the setting.

[SPEECH]

Displays the text-to-speech reading output setting screen when [Text-to-speech output] is selected.

[MOUSE/TRACK PAD]

Displays the screen to set the pointer speed when [Pointer speed] is selected.

Move the slider and select [OK]. Then, the setting is applied.

[Backup & reset]

Each setting and data of the OpenPort PLATFORM part can be restored to the factory default state.

Selecting [Backup & reset] displays the [PERSONAL DATA] screen.

[Factory data reset]

1 Select [Factory data reset] and press <ENTER>.

A confirmation screen is displayed to inform that each type of data will be deleted.

2 Select [Reset tablet] and press <ENTER>.

The final confirmation screen appears.

3 Select [Erase everything] and press <ENTER>.

The OpenPort PLATFORM system restarts, and the settings are restored to the factory default state.

Note

- The following settings and adjusted values will not be changed even if this function is performed.

[Picture], [Sound], [Setup], [Position] and [Options] menus.

To restore these settings to the factory default state, perform [Shipping]. (see page 113)

- When [Screen lock] is set, you will need to unlock it. (see page 58)

■ [SYSTEM]

[Date & time]

Sets the date and time.

This can be set by selecting [SETUP] - [Date & time settings] as well. (see page 46)

Selecting [Date & time] displays the setting screen of date and time.

[Automatic date & time]

Adding a check mark to the check box can use the date and time offered by the network. However, it will be required to set the time zone. Set manually.

[Set date]

Sets the date manually. Use a USB mouse for setting.

If [Automatic date & time] is checked, this item is greyed out.

[Set time]

Sets the time manually. Use a USB mouse for setting.

If [Automatic date & time] is checked, this item is greyed out.

[Select time zone]

Sets the time zone manually.

[Use 24-hour format]

Shows the 24-hour display at the OpenPort PLATFORM part when a check mark is added to the check box.

[Choose date format]

Select the date display format.

Note

- The time can be set up to [2037/12/31 23:59]. If the time reaches [2038/1/1 00:00:00], the unit does not operate normally.
- If the clock shows wrong time soon after set to the right time, replace the battery inside the unit. Consult the dealer where you purchased the product.

[Accessibility]

Selecting [Accessibility] displays the setting screen to assist the user.

[SERVICES]

Displays the service information.

[SYSTEM]

[Captions]: Makes each setting for subtitles.

[ON] / [OFF]

[Language]

[Text size]

[Caption style]

[Magnification gestures]: (This function cannot be used.)

[Large text]:

Enlarges the character size displayed on the screen when a check mark is added to the check box.

[Speak passwords]:

Outputs the password with sound when a check mark is added to the check box.

[Accessibility shortcut]: (This function cannot be used.)

[Text-to-speech output]:

Same setting as [Settings] - [Language & input] - [SPEECH] (see page 59)

[Touch & hold delay]

Sets the time period to press and hold the left button of the USB mouse.

[About tablet]

Displays the following information of OpenPort PLATFORM when [About tablet] is selected.

[Status]

Select [Status] to display the information of network, etc.

[Legal information]

Select [Legal information] to display the open-source license information.

[Model number]

Displays the model number.

[Android version]

Displays the Android version.

[Kernel version]

Displays the kernel version.

[Build number]

Displays the build number.

[CreateShortcut] application

This unit unique application. This application has been registered to [TOOLS].

Creates shortcuts to access specified URLs by browser.

■ **To create a shortcut**

1 Input [Shortcut Name] and [URL].

2 Select [Create] and press <ENTER>.

The shortcut is created in [FAVORITE].

■ **To delete a shortcut**

Selecting [FAVORITE] - [Delete] can delete the registration.

[AppStart] application

This unit unique application. This application has been registered to [TOOLS].

Specifies the URL (browser) or application to launch first when the OpenPort PLATFORM system starts up automatically.

■ **Switching ON/OFF to start up the browser or application at the startup of system.**

[ON]: Starts up the URL (browser) or application specified at the startup of system.

[OFF]: Starts up nothing at the startup of system.

■ **Starting up the browser or application at the startup of system.**

1 Select [Browser] or [Application] and press <ENTER>.

[Browser]: Launches the browser at startup.

[Application]: Launches the application at startup.

2 Select the URL or application to launch from the list, and press <ENTER>.

3 Confirm that the URL or application to launch has been registered, and set the ON/OFF switch to [ON].

■ **To add an URL**

1 Input the URL.

2 Select [Add] and press <ENTER>.

The URL is added to the list.

■ **To delete an URL**

1 Select [Delete Item...] and press <ENTER>.

2 Select the URL to delete from the URL list, and press <ENTER>.

[App Server Setting] application

This unit unique application. This application has been registered to [TOOLS].

Makes the setting to link with the application server.

■ [Request execution time]

Sets the time to send a query to the application server.

[00:00] to [23:59]

Automatically sends a query to the application server at the set time, and performs update if necessary.

■ [Request ban]

Prohibits sending a query when a check mark is added to the check box.

■ [Request execution]

Sends a query immediately after [Request execution] is selected.

The progress bar is displayed while sending the query, and other operations are not available during that time.

[Shutdown] application

This unit unique application. This application has been registered to [TOOLS].

Forcibly shuts down the OpenPort PLATFORM system.

The confirmation message asking [Do you want to shut down?] appears.

[OK]: Starts the shutdown processing.

The power indicator lights up in orange from green illumination, and the message [Shutting down OpenPort PLATFORM. Please wait.] appears.

While the OpenPort PLATFORM system is shutting down, the remote control operation or external control commands are not accepted.

When the shutdown is complete, this unit turns off. The power indicator lights up in red, entering the standby state.

[Cancel]: Returns to the [TOOLS] screen without shutting down.

[Updater] application

This unit unique application. This application has been registered to [TOOLS].

Use this when updating the firmware of the OpenPort PLATFORM system of this unit.

Displays the file list of external storage (microSD card, USB memory (USB (OpenPort PLATFORM) terminal)).

- Select [Search Again] to search the external storage again, then the list will be displayed.
- The extension of update file is zip.

Select the update file from the displayed list, and press <ENTER>.

A confirmation message is displayed. Select [OK] to start the preparation for update. Then, the progress bar is displayed.

When the progress bar reaches 100%, the OpenPort PLATFORM system is reset, and the system to execute begins to be installed.

When the system installation is complete, it is reset again, and restarts.

Note

- Even if the firmware is updated, each setting of OpenPort PLATFORM is not changed.

[SignageBrowser] application

This unit unique application. Register to [FAVORITE] for using. (see page 50)

This is a WEB browser compatible with HTML5 customized for signage use.

Create the shortcut specifying the URL beforehand by selecting [TOOLS] - [CreateShortcut] ([CreateShortcut] application). (see page 60)

Performing the shortcut displays the selection dialogue of the WEB browser to use.

Select [SignageBrowser] on the selection dialogue to connect to the signage WEB server, and this is displayed.

If [Always] is selected on the selection dialogue of the WEB browser, the selection dialogue of the WEB browser is no longer displayed.

Note

- Startup the application after confirming the connection to network.

If the network setting is performed after the application is started up, network connection is not possible. In this case, delete the application on [RECENTS] screen (see page 51, 63), and then startup the application again to connect.

- To display WEB pages for browsing, use the [Browser] application.

[Version] application

This unit unique application. Register to [FAVORITE] for using. (see page 50)

Displays the following versions of the OpenPort PLATFORM system firmware.

uboot version, kernel version and system version

Further details of the kernel version can be confirmed by selecting [TOOLS] - [Settings] - [About tablet]. (see page 60)

[Browser] application

Android standard application. As factory default, this application is registered as [FAVORITE].

Displays WEB pages for browsing.

[Camera] application

Android standard application. As factory default, this application is registered as [FAVORITE].

Connect a USB camera (commercially available) to the USB (OpenPort PLATFORM) terminal for using. If not connected, the [Camera error] message will appear.

Android Standard Home Screen of OpenPort PLATFORM

When the Android standard home screen is selected for the OpenPort PLATFORM home screen, the tutorial screen is displayed at first.

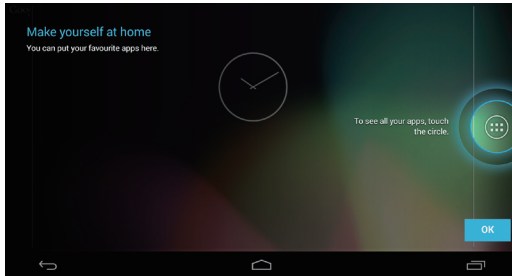

Click the [OK] button on the tutorial screen using a USB mouse (commercially available) (see page 43) to exit the tutorial screen. Then, the operation with remote control, USB mouse, etc. will be possible.

Note

- When the Android standard home screen is selected, the remote control operation is restricted. Operation using a USB mouse is more convenient.

■ Android standard [RECENTS] screen

Click [RECENT APPS] (see page 44) of operation icon using a USB mouse to display the application screen (Android standard screen) recently used.

When the OpenPort PLATFORM system is shut down (see page 40), the history is cleared.

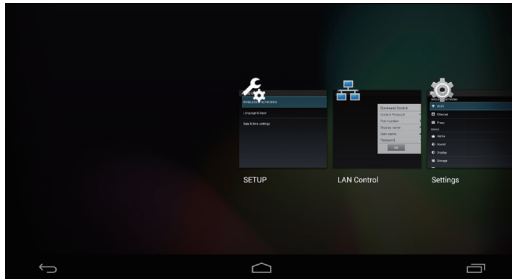

The application can be started up by clicking with the USB mouse.

If the application is swiped and removed to the outside the screen using the USB mouse, this application can be deleted from this screen.

ASPECT Controls

Press <ASPECT> or <ENTER (Unit)> repeatedly to move through the aspect options:

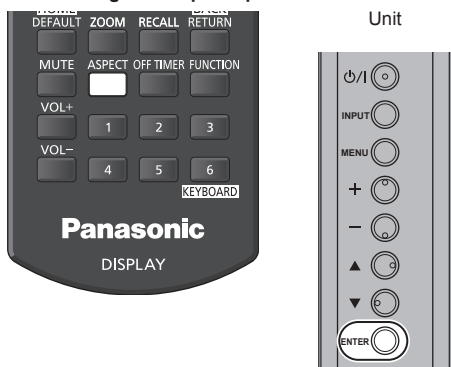

[4:3] → [Zoom1] → [Zoom2] → [16:9]

Note

- The aspect mode is memorised separately for each input terminal.
- When input from USB, the aspect mode is fixed to [16:9].
- When input from OpenPort PLATFORM, the aspect mode is fixed to [16:9].

List of Aspect Modes

Aspect mode	Description
16:9	<p>Picture → Enlarged screen</p> <p>Pictures are displayed filling the screen.</p>

Aspect mode	Description
4:3	<p>Pictures are displayed in the 4:3 area. Pictures with a 4:3 aspect ratio are displayed as is. PC signals are enlarged or reduced to be displayed in the 4:3 area. Side panels are displayed both at the right and left edges of the screen.</p>
	<p>Pictures with a 4:3 aspect ratio in 16:9 signals are displayed with their original aspect ratio. The left and right edges of the pictures are masked by side panels.</p>
Zoom1	<p>Letterbox pictures with a 16:9 aspect ratio are enlarged vertically to fill the screen. The top and bottom edges of the pictures are cut off.</p>
Zoom2	<p>Letterbox pictures with a 16:9 aspect ratio are enlarged vertically and horizontally to fill the screen. The top and bottom edges as well as the left and right edges of the pictures are cut off.</p>

Note

- Do not allow the picture to be displayed in 4:3 mode for an extended period, as this can cause a permanent image retention to remain on the Display Panel.
- Be aware that if you put the display in a public place for commercial purposes or a public showing and then use the aspect mode select function to shrink or expand the picture, you may be violating the copyright under copyright law. It is prohibited to show or alter the copyrighted materials of other people for commercial purposes without the prior permission of the copyright holder.
- In [ENGLISH(US)] OSD language, [16:9] is displayed as [FULL].

Digital ZOOM

Select the screen areas (25 areas) to zoom in, and zoom in the selected image areas $\times 2$, $\times 3$ or $\times 4$.
(Use the remote control. The main unit's buttons cannot be used for operation.)

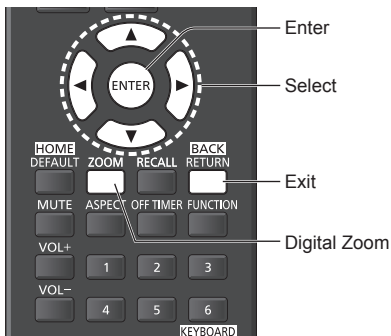

1 Set the digital zoom mode.

Press <ZOOM>.

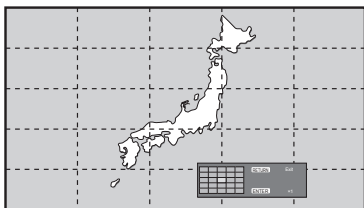

The screen aspect is set to [16:9], and the digital zoom operation guide is displayed.

2 Select the image areas to zoom in.

Select pressing \blacktriangledown \blacktriangle \blacktriangleleft \blacktriangleright .

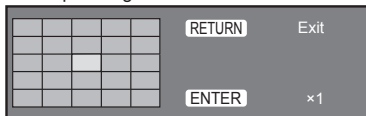

Digital Zoom operation guide

3 Switch the zoom ratio for the screen areas.

Switches every time <ENTER> is pressed.

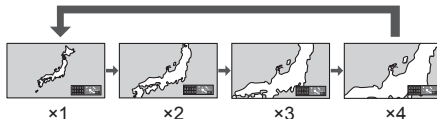

- If no operation is performed for approx. 60 seconds **when the zoom ratio for the screen is " $\times 1$ "**, the unit exits the zoom mode.
- If no operation is performed for approx. 3 seconds **when the zoom ratio for the screen is " $\times 2$ ", " $\times 3$ " or " $\times 4$ "**, the digital zoom operation guide display disappears. Pressing any of the \blacktriangledown \blacktriangle \blacktriangleleft \blacktriangleright buttons displays the guide again.

4 Exit the digital zoom mode.

Press <RETURN> to exit the mode.

The screen returns to the previous state just before entering the digital zoom mode, and the digital zoom operation guide display disappears.

- Press any of the following buttons to exit the mode. Then, the operation of the pressed button is performed.

Remote Control:

<AUTO SETUP> <POSITION> <PICTURE>
<INPUT> <SETUP> <SOUND>
<DEFAULT> <RECALL> <MUTE>
<ASPECT> <OFF TIMER> <FUNCTION>
<VOL +> <VOL -> <1>-<6>

Unit:

<INPUT (Unit)> <MENU (Unit)> <+> (Unit)>
<- (Unit)> \blacktriangle \blacktriangledown <ENTER (Unit)>

- When the screen saver timer starts up, the digital zoom mode finishes.
- When the power is turned OFF, a force-quit is performed.
 - When the power is turned OFF by pressing the <Standby (ON/OFF) button>.
 - When the display is turned OFF at the <Main Power On / Off button>
- When the power is turned OFF by the off-timer
- When the power is turned OFF by [No signal power off] or [Power management].

Note

- In the following cases, the digital zoom mode is not available.
 - When [Multi display setting] is [On]
 - When the screen saver is in operation
 - When USB input is selected.
- The zoomed image is rougher than the original image.
- For multi display use, use the functions in [Multi display settings]. (see page 84)

On-Screen Menu Displays

1 Display the menu screen.

Remote Control

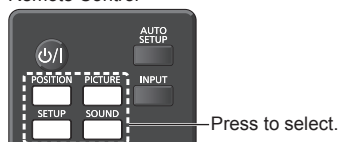

Unit



Each time the button is pressed, the menu screen will switch.

Normal Viewing → [Picture] → [Setup] → [Position]
→ [Sound]

2 Select the item.

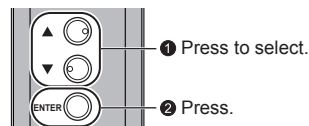

(Example: [Picture] menu)

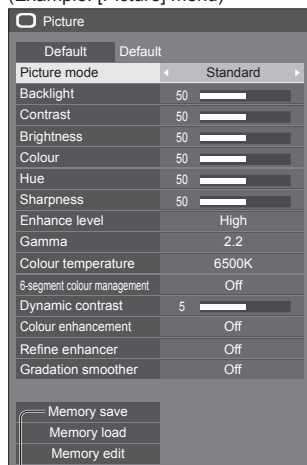

Submenu

Press <ENTER> to display the submenu.

3 Set.

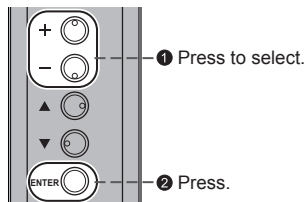

4 Exit from the menu.

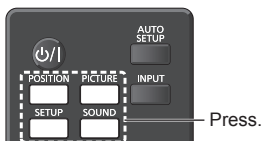

Press <RETURN> to return to the previous screen.



Note

- When changing the settings of the display, picture or sound disturbance may occur temporarily. This is not a malfunction.

Menu display list

- Menu that cannot be adjusted is greyed out.
Adjustable menu changes depending on signal, input and menu setting.

[Position] menu

(see page 68 - 69)

Position	
Default	Default
Auto setup	
H-position	0
H-size	0
V-position	0
V-size	0
Clock phase	15
Dot clock	0
1:1 pixel mode	Off

[Sound] menu

(see page 70)

Sound	
Default	Default
Output select	SPEAKERS
Balance	0
Sound mode	Normal
Bass	0
Treble	0
Surround	Off

[Picture] menu

(see page 71 - 77)

Picture	
Default	Default
Picture mode	Standard
Backlight	50
Contrast	50
Brightness	50
Colour	50
Hue	50
Sharpness	50
Enhance level	High
Gamma	2.2
Colour temperature	6500K
6-segment colour management	Off
Dynamic contrast	5
Colour enhancement	Off
Refine enhancer	Off
Gradation smoother	Off
Memory save	
Memory load	
Memory edit	

[Setup] menu

(see page 78 - 87)

Setup	
1/2	
Signal	
Screensaver	
Input label	
Power management settings	
OpenPort PLATFORM standby	Off
Wobbling	Off
No activity power off	Disable
OSD language	English(UK)

Setup	
2/2	
Multi display settings	
Set up timer	
USB media player settings	
Function button settings	
Display orientation	Landscape
OSD position	Right
Menu display duration	60 sec
Menu transparency	20

Adjusting Position

1 Press <POSITION> to display the [Position] menu.

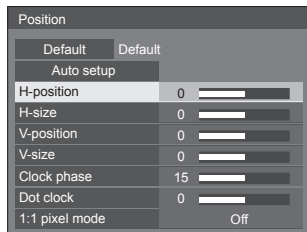

2 Select the item to adjust with ▲ ▼.

- Unadjustable items are greyed out.
- Adjustable items differ depending on the signal, input and the display mode.

3 Adjust with ◀ ▶.

4 Press <POSITION> to exit from adjust mode.

■ To return to the previous screen

Press <RETURN>.

■ To reset to defaults

Press <DEFAULT> while the menu is displayed, or press <ENTER> when [Default] is selected, then the settings will be set to factory settings.

Note

- Settings for [Position] are memorised separately for each input signal.

Setting [Position] when the display is installed vertically

When adjusting, please note that even when the display is installed vertically, setting directions of position / size are the same as that of horizontal installation.

Auto setup

When inputting a PC signal, [H-position] / [V-position], [H-size] / [V-size], [Clock phase] and [Dot clock] are automatically corrected.

This setting is enabled under the following condition:

- When inputting from PC IN or RGB IN

While displaying the picture of the corresponding signal, select [Auto setup] and press <ENTER>.

Using Remote Control

Press <AUTO SETUP>.

When Auto Setup does not work, [Invalid] is displayed.

Auto mode

When the [PC auto setting] is set to [On] in the [Options] menu (see page 93), automatic position adjustment starts under the following conditions:

- When the display power is turned ON.
- When the input signal is switched.

Note

- When the dot clock frequency of a PC signal is 162 MHz or higher, [Clock phase] and [Dot clock] cannot be automatically corrected.
- Auto Setup may not work when a cropped or dark image is input. In such case, switch to a bright image with borders and other objects are clearly shown, and then try auto setup again.
- Depending on the signal, out of alignment may occur after Auto Setup. Carry out fine tuning for the position/size as required.
- If Auto Setup cannot set properly for XGA signal (1024×768, 1280×768, 1366×768), pre-selecting the individual signal in [XGA mode] (see page 79) may result in correct Auto Setup.
- Accurate auto setup is not possible when a signal such as additional information is superimposed out of valid image period or when intervals between synchronizing signal and image signal are short. Also, accurate auto setup is not possible when image signals with tri level synchronizing signal added, or when some SYNC ON G signals are input.
- If Auto Setup does not work well, select [Default], press <ENTER>, and then adjust the position/size manually.

[H-position] Adjust the horizontal position with ◀▶.

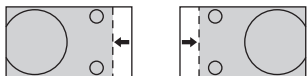

[H-size] Adjust the horizontal size with ◀▶.

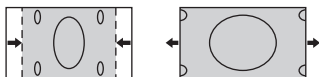

[V-position] Adjust the vertical position with ◀▶.

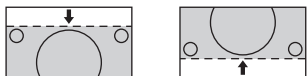

[V-size] Adjust the vertical size with ◀▶.

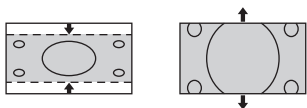

[Clock phase] (For RGB IN or PC IN input)

In some cases, frame of the screen appears blurred or smudged, when RGB signal or PC signal are input.

[Dot clock] (For RGB IN or PC IN input)

Periodic striped pattern interference (noise) may occur when a striped pattern is displayed. If this happens, adjust so that any such noise is minimized.

[Over scan] Turn image over scan On/Off.

Applicable input signal:

525i, 525p, 625i, 625p, 750/60p, 750/50p
(Component Video, RGB, DVI-D, HDMI)

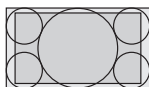

[On]

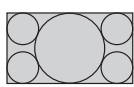

[Off]

Note

- When [Off] is set, [H-size] and [V-size] cannot be adjusted.

[1:1 pixel mode] Adjusts the display size when 1125i or 1125p signal is input.

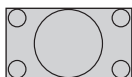

[Off]



[On]

Applicable input signal:

1125 / 50i, 60i, 24PsF, 24p, 25p, 30p, 50p, 60p

Note

- Select [Off] when flickering is shown around the image.
- [H-size] and [V-size] cannot be adjusted when [On] is selected.

Note

- In some cases, noise appears outside the area picture is displayed, but it is not a malfunction.

Sound Adjustment

1 Press <SOUND> to display the [Sound] menu.

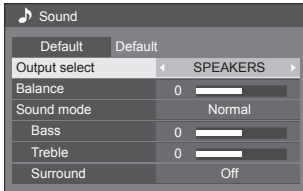

2 Select the item to adjust with ▲ ▼.

- Menu that cannot be adjusted is greyed out.

3 Adjust with ◀ ▶.

4 Press <SOUND> to exit from adjust mode.

■ To return to the previous screen

Press <RETURN>.

■ To reset to defaults

Press <DEFAULT> while the menu is displayed, or press <ENTER> when [Default] is selected, then the settings will be set to factory settings.

[Output select] Select the audio output.

[SPEAKERS]:

Internal speakers

[AUDIO OUT]:

AUDIO OUT terminal output

- When [AUDIO OUT] is selected, the other menus are greyed out and cannot be selected.
- Audio volume setting is memorized separately for each output.

[Balance] Adjusts left and right volumes.

[Sound mode] Select for best audio.

[Normal]:

Emits the original sound.

[Dynamic]:

Accentuates sharp sound.

[Clear]:

Attenuates human voice.

- In [ENGLISH(US)] OSD language, [Sound mode] and [Normal] are displayed as [AUDIO MENU] and [STANDARD].

[Bass] Adjusts low pitch sounds.

[Treble] Adjusts high pitch sounds.

[Surround]

[Off]:

Normal sound

[On]:

Surround sound

Note

- [Bass], [Treble] and [Surround] settings are memorised separately for [Normal], [Dynamic] and [Clear] in [Sound mode].

Picture Adjustments

1 Press <PICTURE> to display the [Picture] menu.

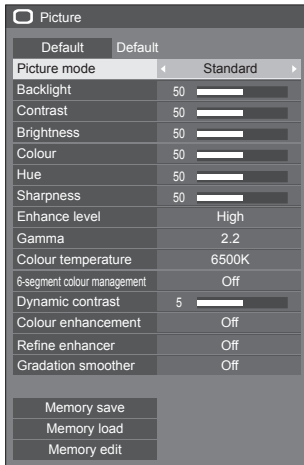

2 Select the item to adjust with ▲ ▼.

- Menu that cannot be adjusted is greyed out.

3 Adjust with ◀ ▶.

4 Press <PICTURE> to exit from adjust mode.

■ To return to the previous screen

Press <RETURN>.

■ To reset to defaults

Press <DEFAULT> while the menu is displayed, or press <ENTER> when [Default] is selected, then the settings will be set to factory settings.

Note

- When displaying still picture with USB input (USB media player), only the following settings have an effect on the picture.

[Backlight], [Gamma], [Colour temperature]

[Picture mode]

This menu switches to easy-to-see pictures suitable to the picture source or environment where this unit is used.

[Vivid signage]:

Suitable for signage applications featuring more vivid and sharper images in bright environments such as a shop.

[Natural signage]:

Suitable for signage applications such as merchandise exhibition, featuring natural tone images with colour reproduction emphasized under light.

[Standard]:

Faithfully reproduces original picture.

[Surveillance]:

Tone-focused pictures with brightness reduced suitable for input from a monitoring camera.

[Graphic]:

Suitable for PC input.

[DICOM]:

Pictures close to the grayscale standard DICOM Part14.

- The settings are memorised separately for each input terminal.

Note

- DICOM is the abbreviation for "Digital Imaging and Communications in Medicine", which is a standard for communications between medical imaging devices. Although "DICOM" is used as a picture mode name, this unit is not a medical device. Do not use displayed images for such purposes as diagnosis.

[Backlight]

Adjusts luminance of the back light.

Darker ↔ Brighter

[Contrast]

Selects the proper brightness and density for the room.

Less ↔ More

- In [ENGLISH(US)] OSD language, [Contrast] is displayed as [PICTURE].

[Brightness]

Adjusts for easier viewing of dark pictures.

Darker ↔ Brighter

[Colour]

Adjusts colour saturation.

Less ↔ More

[Hue]

Adjusts hue of skin colour.

Reddish ↔ Greenish

- In [ENGLISH(US)] OSD language, [Hue] is displayed as [TINT].

[Sharpness] Adjusts picture sharpness.

Less ↔ More

[Enhance level] Switches the effect range for sharpness.

[High]: Large effect

[Low]: Small effect

[Gamma] Adjusts gamma.

[2.0], [2.2], [2.4], [2.6], [DICOM]:

Small tilt - Large tilt

Note

- When [DICOM] is selected in [Picture mode], [Gamma] is fixed to [DICOM].

When the items other than [DICOM] are selected in [Picture mode], [DICOM] cannot be set for [Gamma].

[Colour temperature] Adjusts colour tone.

[3200K], [4000K], [5000K], [6500K], [7500K], [9300K], [10700K], [Native], [USER1], [USER2]

Note

- Emphasizes red when the numerical value of [Colour temperature] is small, and emphasizes blue when it is big.
- [Native] is a colour tone of the panel element. When this is selected, [Gamma] is fixed to 2.2 or equivalent and it cannot be adjusted.
- When [DICOM] is selected in [Picture mode], only [6500K] and [9300K] can be selected.

User setting of [Colour temperature]

2 kinds of detailed [Colour temperature] settings ([USER1] and [USER2]) can be stored.

1 Press <ENTER> while setting [Colour temperature].

Enhance level	High
Gamma	2.2
Colour temperature	◀ 6500K ▶

Example:

When [Colour temperature] is [6500K], it is possible to reflect the set point, [6500K], to the set point of [USER1] and [USER2].

2 Select the user to memorise settings with ▲ ▼ and press <ENTER>.

Adjust colour temperature	
Change to 6500K	
USER1	▶
USER2	▶

3 Select [Yes] with ◀ ▶ and press <ENTER>.

Adjust colour temperature	
Overwrite colour temperature "USER1"?	
Yes	No

4 Set each item on detail settings screen.

Adjust colour temperature	
USER1	
R gain	255
G gain	150
B gain	64
R bias	0
G bias	0
B bias	0

[R gain]

Adjusts the white balance for light red areas.

0 to 255

[G gain]

Adjusts the white balance for light green areas.

0 to 255

[B gain]

Adjusts the white balance for light blue areas.

0 to 255

[R bias]

Adjusts the white balance for dark red areas.

-127 to 128

[G bias]

Adjusts the white balance for dark green areas.

-127 to 128

[B bias]

Adjusts the white balance for dark blue areas.

-127 to 128

The settings are saved for the user. When you return to [Picture] menu, the user you have set is selected for [Colour temperature].

Enhance level	High
Gamma	2.2
Colour temperature	◀ USER1 ▶

[6-segment colour management]

Adjusts the colour tone of R (red), G (green), B (blue) and complementary colours (cyan, magenta and yellow) on the screen individually.

- 1 Set [6-segment colour management] to [On], and then press <ENTER>.

Gamma	2.2
Colour temperature	6500K
6-segment colour management	On
Dynamic contrast	5

- 2 Set each item on detail settings screen.

6-segment colour management	
Select colour	Red
Hue	0
Saturation	0
Value	0
Reset	

[Select colour]

Select the colour to adjust with ◀▶.

[Hue]

Adjusts colour balance.

- 511 to + 511

[Saturation]

Adjusts gradations of colour.

- 127 to + 127

[Value]

Adjusts brightness of colour.

- 127 to + 127

[Reset]

Resets to defaults. Select [Yes] with ◀▶ and press <ENTER>.

- In [ENGLISH(US)] OSD language, [Hue] is displayed as [TINT].

[Dynamic contrast]

Automatically adjusts the contrast by determining the changes in the use of colours for images that constantly change, such as motion pictures.

No effect ↔ **Large effect**

[Colour enhancement]

Displays images by emphasising colours.

[Off], [Low], [Mid], [High]
(Small effect to Large effect)

[Refine enhancer]

Enhances the sense of resolution by correcting fuzzy outlines of pictures resulted from resizing, etc.

[Off], [Low], [Mid], [High]
(Small effect to Large effect)

[Gradation smoother]

Extracts and eliminates noise components from the input video signals, and then displays noiseless pictures.

[Off], [On]

Picture Profiles

Up to 6 combinations of picture adjustment values (in the [Picture] menu) can be stored in the display memory as profiles and applied as needed, for a convenient way to enjoy your preferred picture settings.

Picture	
Default	Default
Picture mode	Standard
Backlight	50
Contrast	50
Brightness	50
Colour	50
Hue	50
Sharpness	50
Enhance level	High
Gamma	2.2
Colour temperature	6500K
6-segment colour management	Off
Dynamic contrast	5
Colour enhancement	Off
Refine enhancer	Off
Gradation smoother	Off
Memory save	
Memory load	
Memory edit	

[Memory save]

(see page 74)

[Memory load]

(see page 75)

[Memory edit]

(see page 75)

1. []	MEMORY1
2. [*]	MEMORY2
3. [*]	MEMORY3
4. []	MEMORY4
5. []	MEMORY5
6. []	MEMORY6

Overview of Picture Profiles

Original picture



Adjust picture.
(see page 71 - 73)



Custom picture



Example:
Save the picture adjustment values in the [MEMORY 1] profile.
[Memory save]

Original picture



Example:
Load [MEMORY 1].
[Memory load]



Custom picture



[Memory edit] screen

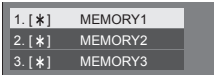

Example:
Change the memory name to [MY PICTURE].
[Memory edit]

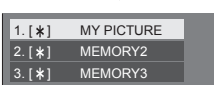

Saving profiles

Follow these steps to save picture adjustment values as profiles.

- 1 Specify the picture quality in the [Picture] menu.
(see page 71 - 73)
- 2 In the [Picture] menu, select [Memory save] with ▲ ▼ and press <ENTER>.

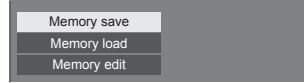

- 3 Select a profile name for saving the picture adjustment values with ▲ ▼ and press <ENTER>.

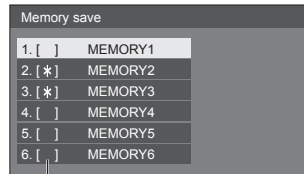

- [*] appears for a profile in which the picture adjustments have already been saved.

- 4 Select [Ok] with ◀▶ and press <ENTER>.

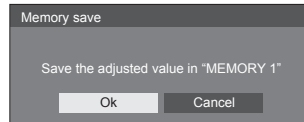

- 5 Enter a profile name with ▲ ▼ ◀▶.

- Entering profile names (see page 76)



6 When you finished entering the profile name, select [Ok] with ▲ ▼ ◀ ▶ and press <ENTER>.



- To cancel saving the profile, select [Cancel].

Loading profiles

Load profiles and apply the picture adjustment values to the display as follows.

1 In the [Picture] menu, select [Memory load] with ▲ ▼ and press <ENTER>.

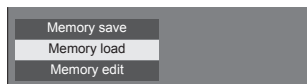

2 Select the profile to load with ▲ ▼ and press <ENTER>.

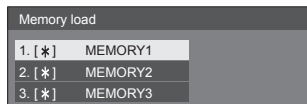

Loading profiles using numeric buttons on the remote control.

Each numeric button <1> - <5> is allocated for loading [MEMORY 1] to [MEMORY 5].

[Function button settings] (see page 85)

1 Press any of <1> - <5>.

2 Select [Ok] with ◀ ▶ and press <ENTER>.

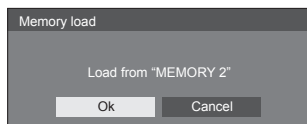

When profile is being loaded, profile name is displayed.

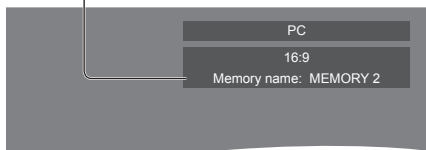

Note

- Loaded profiles are stored in memory according to the selected input terminal.

Editing profiles

Delete or rename profiles as follows.

Deleting profiles

1 In the [Picture] menu, select [Memory edit] with ▲ ▼ and press <ENTER>.

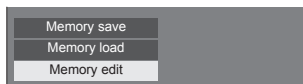

2 Select [Memory delete] with ▲ ▼ and press <ENTER>.

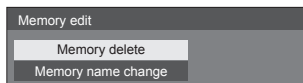

3 Select the profile to delete with ▲ ▼ and press <ENTER>.

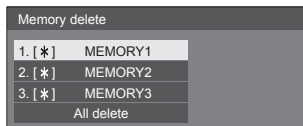

- To delete all profiles, select [All delete].

4 Select [Ok] with ◀ ▶ and press <ENTER>.

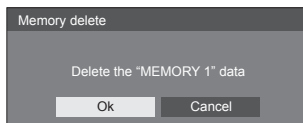

Renaming profiles

1 In the [Picture] menu, select [Memory edit] with ▲ ▼ and press <ENTER>.

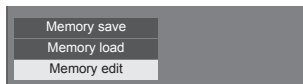

2 Select [Memory name change] with ▲ ▼ and press <ENTER>.

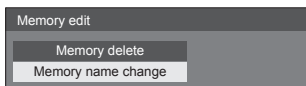

3 Select the profile to rename with ▲ ▼ and press <ENTER>.

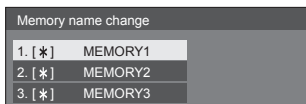

4 Enter a name for the profile with ▲ ▼ ◀ ▶.

- Entering profile names (see page 76)



5 When you finished entering the profile name, select [Ok] with ▲ ▼ ◀ ▶ and press <ENTER>.



- To cancel renaming the profile, select [Cancel].

Entering profile names

To enter a profile name, select characters in the on-screen keyboard.



The default profile name is [MEMORY 1], here, we are changing it to [MY PICTURE] as an example.

1 Select [All delete] with ▲ ▼ ◀ ▶, and press <ENTER>.

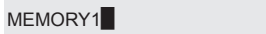

All text is deleted.

To delete individual characters, select [Delete].

2 Select [a / A / @] with ▲ ▼ ◀ ▶, and press <ENTER>.



Switches the keyboard to the upper case alphabet. Each time <ENTER> is pressed, the keyboard is switched in the order of lower case, upper case and symbols.

3 Select [M] with ▲ ▼ ◀ ▶, and press <ENTER>.

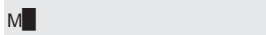

Repeat this process to enter the next character.

4 Select Space key with ▲ ▼ ◀ ▶, and press <ENTER>.

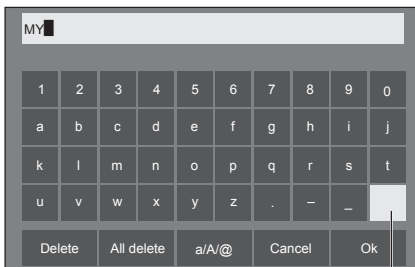

Space key

As shown in step 3, select the characters to enter [PICTURE].

5 When you finished entering the profile name, select [Ok] with ▲ ▼ ◀ ▶ and press <ENTER>.

The image shows a screenshot of a user interface for entering a profile name. At the top, there is a text input field labeled "MY PICTURE" with a cursor. Below the input field is a grid of buttons for character selection. The grid is organized as follows:

1	2	3	4	5	6	7	8	9	0
a	b	c	d	e	f	g	h	i	j
k	l	m	n	o	p	q	r	s	t
u	v	w	x	y	z	.	-	_	

Below the grid is a row of five buttons: "Delete", "All delete", "a/A/@", "Cancel", and "Ok".

- To cancel saving the profile, select [Cancel].

Setup menu

1 Press <SETUP> to display the [Setup] menu.

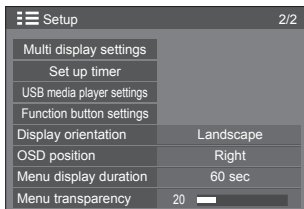
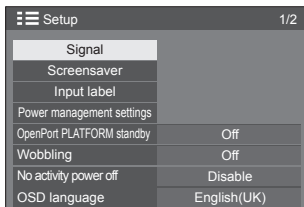

2 Select the item to set with ▲ ▼.

- Menu that cannot be adjusted is greyed out.
Adjustable menu changes depending on signal, input and menu setting.

3 Set with ◀ ▶.

4 Press <SETUP> to exit from adjust mode.

■ To return to the previous screen

Press <RETURN>.

Signal

Examples of [Signal] submenu screen

When OpenPort PLATFORM is selected

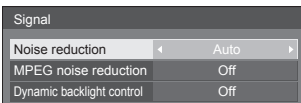

When HDMI / DVI is selected

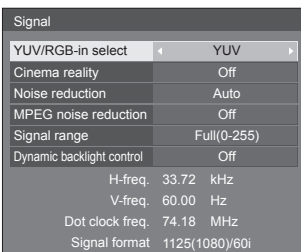

When PC is selected

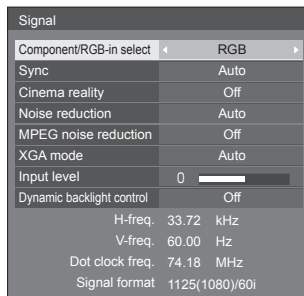

When COMPONENT / RGB is selected

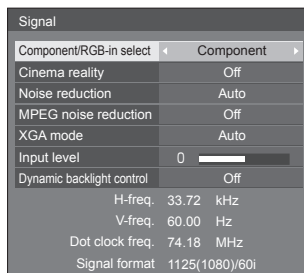

When VIDEO is selected

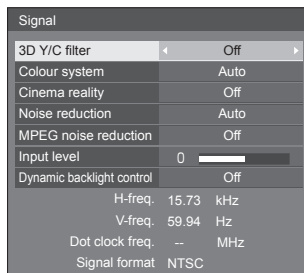

When USB is selected



Note

- [Signal] setup menu displays a different setting condition for each input signal.
- Menu that cannot be adjusted is greyed out.

■ [Component/RGB-in select]

This menu is displayed at PC IN and COMPONENT/RGB IN inputs.

Select to match the signals from the source connected to each terminal.

[Component] YPbPr/YCbCr signals

[RGB] RGB signals

Note

- Set for each input terminal (COMPONENT/RGB IN, PC IN).

■ [YUV/RGB-in select]

This menu is displayed at HDMI 1, HDMI 2 and DVI-D IN inputs.

Select to match the signals from the source connected to each terminal.

[YUV] YUV signals

[RGB] RGB signals

Note

- Set for each input terminal (HDMI 1, HDMI 2, DVI-D IN).

■ [Sync]

This menu is displayed at PC IN input.

Setting RGB/PC sync signal

[Auto]:

The H and V sync or synchronized signal is automatically selected. When both of them have sync signal, H and V sync will be selected.

When displaying CS signal, connect to HD input terminal.

[on G]:

Uses a synchronized signal on the Video G signal, which is input from the G connector.

[HV sync]:

Uses a synchronized signal on the Video HD/VD signal, which is input from the HD/VD connector.

Setting Component sync signal

[Auto]:

The H and V sync or synchronized signal is automatically selected. When both of them have sync signal, H and V sync will be selected.

When displaying CS signal, connect to HD input terminal.

[on Y]:

Uses a synchronized signal on the Video Y signal, which is input from the Y connector.

[HV sync]:

Uses a synchronized signal on the Video HD/VD signal, which is input from the HD/VD connector.

■ [Cinema reality]

Faithfully reproduces videos shot with cinema films. Set this to [Off] normally.

Note

- In [ENGLISH(US)] OSD language, [Cinema reality] is displayed as [3:2 PULLDOWN].
- If [Cinema reality] is set to [On], videos including movies shot at 24 frames per second are reproduced more naturally.
- If the video is unnatural with [On] set, set it to [Off].

■ [Noise reduction]

Reduces picture noise.

[Off]:

Disables Noise Reduction.

[Min], [Mid], [Max]:

Sets strength of Noise Reduction.

[Auto]:

Noise reduction will be automatically selected from [Min], [Mid] or [Max].

■ [MPEG noise reduction]

Reduces block noise and mosquito noise on MPEG videos.

[Off]:

Disables Noise Reduction.

[Min], [Mid], [Max]:

Sets strength of Noise Reduction.

■ [XGA mode]

This menu is displayed at PC IN and COMPONENT/RGB IN inputs.

This unit supports XGA signals (1024 × 768, 1280 × 768, 1366 × 768) having different aspect ratios and sampling rates.

[Auto]:

Automatically detects the signal.

Switch the setting to suit the input signal for better display depends on the angle of view or display resolution condition.

Note

- After making this setting, be sure to make each adjustment (such as [Auto setup]) on the [Position] menu as necessary. (see page 68)

■ [Signal range]

This menu is displayed at HDMI1, HDMI2 and DVI-D IN inputs. Switches the dynamic range to match the signals from the source connected to each terminal.

[Video(16-235)]:

If the input signal is the video range

Example: HDMI terminal output for DVD player

[Full(0-255)]:

If the input signal is full range

Example: HDMI terminal output for personal computer

[Auto]:

Switches the dynamic range automatically between [Video(16-235)] and [Full(0-255)] according to the input signal.

Note

- [Auto] can be selected when the HDMI signal input.

■ [Input level]

This menu is displayed at PC IN, COMPONENT/RGB IN and VIDEO IN inputs.

Adjustment of parts which are extremely bright and hard to see.

- 16 to + 16:
(Level low) - (Level high)

■ [3D Y/C filter]

Set this if the video looks unnatural at VIDEO IN input. Set this to [On] normally.

Note

- Depending on the signalling system, this setting may be less effective or may not be effective at all.

■ [Colour system]

Sets the colour system according to the signal method at VIDEO IN input. Set this to [Auto] normally. This automatically detects the input signal format.

[Auto], [PAL], [SECAM], [NTSC], [NTSC 4.43], [PAL M], [PAL N]:

Set this to [Auto] when viewing PAL-60 videos.

When images are unstable

When the system is set to [Auto], images become unstable in rare case under the condition that the input signals are at low level or have many noises. In this case, set the system so it conforms with the input signal format.

■ [Dynamic backlight control]

Improves picture contrast and alleviates whiteness by controlling the back light when signals with the low average brightness level (APL) are input.

[On]:

The function is enabled.

[Off]:

The function is disabled.

Note

- When this function is operating, the on-screen brightness becomes lower.
- If the [Dynamic backlight control] setting is different for each input, the on-screen brightness may change by switching input.
- Depending on the displayed image, the screen may flicker. If this annoys you, set [Dynamic backlight control] to [Off].

■ Input signal display

Displays the frequency and the type of the current input signal.

H-freq.	33.72	kHz
V-freq.	60.00	Hz
Dot clock freq.	74.18	MHz
Signal format	1125(1080)/60i	

Display range:

Horizontal (15 kHz - 135 kHz)

Vertical (24 Hz - 120 Hz)

The dot clock frequency is displayed when Digital and PC signal are input.

Screensaver

(For preventing image retention)

Do not display a still picture, especially in 4:3 mode, for any length of time.

If the display must remain on, a Screensaver should be used.

[Screensaver] - submenu screen

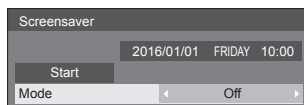

■ Screensaver settings

Screensaver operation

When the Screensaver is operating, the following 5 patterns are displayed full screen for 5 seconds each, and it will be repeated.

Black → Dark grey → Grey → Light grey → White → Light grey → Grey → Dark grey

To start Screensaver now

- ① Select [On] in [Mode].
- ② Select [Start] and press <ENTER>.
 - The Screensaver will be activated.

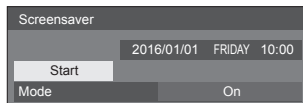

Note

- If the following buttons are pressed while the screen saver is operating, the screen saver is cancelled.
Remote control: <RETURN>
Main unit: <MENU (Unit)> <INPUT (Unit)> <+ (Unit)> <- (Unit)> ▲ ▼ <ENTER (Unit)>
- When the display is turned off, the Screensaver will be deactivated.

To set interval of Screensaver

- ① Select [Interval] in [Mode].
- ② Set [Periodic time].
 - Press ◀▶ to change the time by 15 minutes.
 - In [ENGLISH(US)] OSD language, [Periodic time] is displayed as [SHOW DURATION].
- ③ Set [Operating time].
 - Press ◀▶ once to change the time by 1 minute. Keep pressing down to change the time by 15 minutes.
 - In [ENGLISH(US)] OSD language, [Operating time] is displayed as [SAVER DURATION].

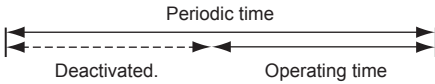
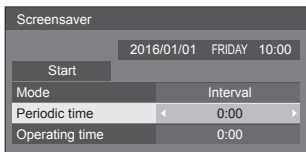

Note

- It is not possible to set the duration of [Operating time] longer than that of [Periodic time].

To set start and finish time of Screensaver

- Select [Time designation] in [Mode].
- Set [Start time] and [Finish time].
 - Press ◀▶ once to change the time by 1 minute. Keep pressing down to change the time by 15 minutes.
 - In [ENGLISH(US)] OSD language, [Time designation] is displayed as [TIME OF DAY].

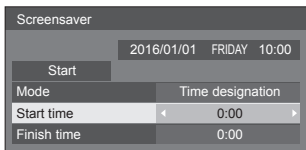

Note

- Please set [Date & time] in OpenPort PLATFORM before setting [Start time] and [Finish time]. (see page 59)
- This can be set only when the date is 2016/01/01 and after.

To turn the power off after Screensaver

- Select [Standby after SCR saver] in [Mode].
- Set [Screensaver duration].
 - Press ◀▶ once to change the time by 1 minute. Keep pressing down to change the time by 15 minutes.
- Select [Start] and press <ENTER>.
 - Screensaver will be activated and the power will be turned off (standby) at the time set.

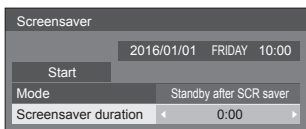

Note

- [Screensaver duration] can be set from 0:00 to 23:59.

When this is set to [0:00], [Standby after SCR saver] will not be activated.

Input label

This function can change the label of the Input signal to be displayed.

[Input label] - submenu screen

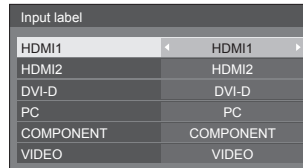

[HDMI1]	[HDMI1] / [DVD1] / [DVD2] / [DVD3] / [Blu-ray1] / [Blu-ray2] / [Blu-ray3] / [CATV] / [VCR] / [STB] / (Skip)
[HDMI2]	[HDMI2] / [DVD1] / [DVD2] / [DVD3] / [Blu-ray1] / [Blu-ray2] / [Blu-ray3] / [CATV] / [VCR] / [STB] / (Skip)
[DVI-D]	[DVI-D] / [DVD1] / [DVD2] / [DVD3] / [Blu-ray1] / [Blu-ray2] / [Blu-ray3] / [CATV] / [VCR] / [STB] / (Skip)
[PC]	[PC] / [DVD1] / [DVD2] / [DVD3] / [Blu-ray1] / [Blu-ray2] / [Blu-ray3] / [CATV] / [VCR] / [STB] / (Skip)
[COMPONENT]*	[COMPONENT] / [DVD1] / [DVD2] / [DVD3] / [Blu-ray1] / [Blu-ray2] / [Blu-ray3] / [CATV] / [VCR] / [STB] / (Skip)
[VIDEO]	[VIDEO] / [DVD1] / [DVD2] / [DVD3] / [Blu-ray1] / [Blu-ray2] / [Blu-ray3] / [CATV] / [VCR] / [STB] / (Skip)

(Skip): When <INPUT> is pressed, the input will be skipped.

*: [COMPONENT] may be displayed as [RGB] depending on the settings of [Component/RGB-in select]. (see page 78)

Power management settings

Set each item to reduce power consumption.

[Power management settings] - submenu screen

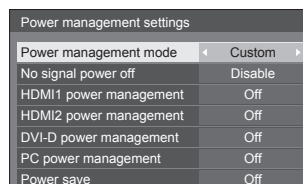

■ [Power management mode]: [On]

The following fixed values are set to the menu of power consumption reduction. Individual setting is not available.

[No signal power off]: [Enable]

[HDMI1 power management]: [On]

[HDMI2 power management]: [On]

[DVI-D power management]: [On]

[PC power management]: [On]

[Power save]: [On]

■ [Power management mode]: [Custom]

The menu of the power consumption reduction is individually set. This setting is enabled when [Power management mode] is set to [Custom].

[No signal power off]

When this is set to [Enable], the power supply of the unit goes off automatically (standby) when there is no operation or sync signal for about 10 minutes.

Note

- With the USB input, the unit determines no signal is present when the USB memory is not connected to the USB terminal.
- The OpenPort PLATFORM input is not a target of the "no signal" detection.

[HDMI1 power management]

[HDMI2 power management]

When this function is set to [On], it operates under the following conditions to turn the power on or off automatically.

When no pictures (sync signal) are detected for 60 seconds or so at HDMI1 or HDMI2 input:

Power is turned off (sleep); the power indicator lights up orange.

When pictures (sync signal) are subsequently detected:

Power is turned on; the power indicator lights up green.

Note

- For TH-55AF1U, TH-49AF1U and TH-42AF1U, when the power is turned off, the OpenPort PLATFORM system is shutdown once, and then restarted. During that time (approx. 60 seconds), the power on processing by detecting pictures (sync signal) is not accepted.

[DVI-D power management]

When this function is set to [On], it operates under the following conditions to turn the power on or off automatically.

When no pictures (sync signal) are detected for 60 seconds or so at DVI-D input:

Power is turned off (sleep); the power indicator lights up orange.

When pictures (sync signal) are subsequently detected:

Power is turned on; the power indicator lights up green.

Note

- For TH-55AF1U, TH-49AF1U and TH-42AF1U, when the power is turned off, the OpenPort PLATFORM system is shutdown once, and then restarted. During that time (approx. 60 seconds), the power on processing by detecting pictures (sync signal) is not accepted.

[PC power management] (DPMS function)

When this function is set to [On], it operates under the following conditions to turn the power on or off automatically.

When no pictures (HD/VD sync signals) are detected for 60 seconds or so at PC input:

Power is turned off (sleep); the power indicator lights up orange.

When pictures (HD/VD sync signals) are subsequently detected:

Power is turned on; the power indicator lights up green.

Note

- This function is effective when [Sync] in [Signal] is set to [Auto] or [HV sync] and [Component/RGB-in select] are set to [RGB]. (see page 78)
- For TH-55AF1U, TH-49AF1U and TH-42AF1U, when the power is turned off, the OpenPort PLATFORM system is shutdown once, and then restarted. During that time (approx. 60 seconds), the power on processing by detecting pictures (HD/VD sync signals) is not accepted.

[Power save]

This function adjusts the brightness of the backlight to reduce power consumption.

[Off]:

This function does not operate.

[On]:

Backlight brightness is reduced.

Note

- If [Input search] is set to items other than [Off], the [Input search] function is prioritised. (The "Power management" function does not operate for each terminal.) (For details of [Input search] function, see page 88.)
- If [Failover/Failback] - [Input change mode] is set to items other than [Off], the [Failover/Failback] function is prioritised. (The "Power management" function does not operate for each terminal.) (For details of [Failover/Failback] function, see page 89.)

OpenPort PLATFORM standby

This switches the operation status of the OpenPort PLATFORM system in standby mode.

For TH-55AF1W, TH-49AF1W and TH-42AF1W

[Off]:

When the power is turned off with remote control, etc.

Shuts down the OpenPort PLATFORM system.

When it is in standby condition (Power Indicator: Red)

It is possible to startup with remote control or RS-232C, but it is not possible to startup with timer setting, wired LAN or wireless LAN.

[On] (Factory default):

When the power is turned off with remote control, etc.

Does not shut down the OpenPort PLATFORM system.

When it is in standby condition (Power Indicator: Orange)

It is possible to startup with timer setting, wired LAN and wireless LAN.

For TH-55AF1U, TH-49AF1U and TH-42AF1U

[Off] (Factory default):

When the power is turned off with remote control, etc.

Shuts down the OpenPort PLATFORM system.

When it is in standby condition (Power Indicator: Red)

It is possible to startup with remote control or RS-232C, but it is not possible to startup with timer setting, wired LAN or wireless LAN.

[On]:

When the power is turned off with RS-232C control or LAN control

Does not shut down the OpenPort PLATFORM system.

When the power is turned off with something other than RS-232C control or LAN control

Shuts down the OpenPort PLATFORM system once, and then restarts the system. During that time (approx. 60 seconds), the power on processing is not accepted.

When it is in standby condition (Power Indicator: Orange)

It is possible to startup with timer setting, wired LAN and wireless LAN.

Wobbling

Automatically shifts the display image (therefore unnoticeable to the eye) to prevent image retention of sharper contour of image.

Setting this to [On] moves the screen position at certain intervals and displays the images.

Note

- If [Multi display setting] is set to [On], this function does not operate. (see page 84)
- When this function is operating, part of the screen may appear to be missing.

No activity power off

When this function is set to [Enable], the power is turned off (standby) automatically when there is no operation of the Display for 4 hours.

Starting from 3 minutes before the turn off, the remaining time will be displayed.

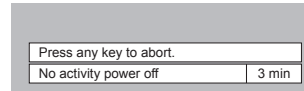

When the power is turned off due to this function, a message [Last turn off due to 'No activity power off'.] is displayed next time the power is turned on.

Note

- While the screensaver is running, this function is disabled.
- This function is not activated with OpenPort PLATFORM input.

OSD language

Select your preferred language.

Selectable languages

English(UK)

Deutsch

Français

Italiano

Español

ENGLISH(US)

中文 : Chinese

日本語 : Japanese

Русский : Russian

Note

- It is also possible to set language in [Language & input] in OpenPort PLATFORM. (see page 58)
- The display may be greyed out and setting cannot be made in some conditions, such as when the OpenPort PLATFORM system is starting up.

Multi display settings

1 to 10 displays can be aligned in horizontal direction and vertical direction respectively, and those displays are regarded as one group. The enlarged image is shown on the combined display.

[Multi display settings]- submenu screen

Multi display settings	
Multi display setting	Off
Horizontal scale	2
Vertical scale	2
Bezel H adjustment	0
Bezel V adjustment	0
Location	A1

Note

- The settings are memorised separately for each input terminal.
- When the multi display is set to [Off], adjust to the same angle of view for [Position] (see page 68). Then, set the multi display to [On]. Again, make fine adjustment of the angle of view for [Position].
- The [Position] menu can be adjusted in the multi display status.

■ [Multi display setting]

[Off]:

The display is not divided when enlarged.

[On]:

The display is divided when enlarged.

When [On] is set, the display aspect is [16:9].

■ [Horizontal scale]

Set the horizontal scale in the multi display.

1 to 10 (1 to 2 for USB input)

■ [Vertical scale]

Set the vertical scale in the multi display.

1 to 10 (1 to 2 for USB input)

Example:

[Horizontal scale] [5] and [Vertical scale] [5] is set in the multi display

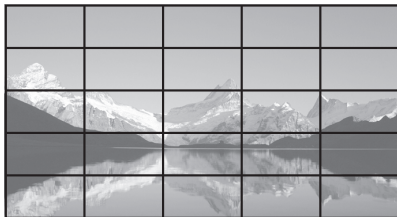

■ [Bezel H adjustment], [Bezel V adjustment]

Adjust the area of image hidden in the joint horizontally and vertically respectively.

0 to 100

Display example

Setting value: 0



Displays the entire image including the joint area. (Suitable when displaying character information on PC.)

Setting value: 100



Does not display the image of the joint area. (Suitable when displaying motion pictures.)

■ [Location]

Assign the multi display position.

Example:

[Horizontal scale] [10], [Vertical scale] [10]

A1	A2	...	A9	A10
B1	B2	...	B9	B10
...
I1	I2	...	I9	I10
J1	J2	...	J9	J10

Select from A1 to J10.

- The displayed content for setting changes according to the settings for the [Horizontal scale] and [Vertical scale].
- By setting [Multi display setting] to [Off], it is possible to check the location on the screen while the setting menu is displayed.

Set up timer

Sets the program to turn the power on/off or switch video inputs at the specified time. Up to 20 programmes can be set.

Note

- Set [Date & time] in OpenPort PLATFORM before setting [Set up timer]. (see page 59)
- This can be set only when the date is 2016/01/01 and after.
- When multiple programs are set at the same time, the program with the smallest program number is enabled.
- To set programme to turn the power on/off, set [OpenPort PLATFORM standby] to [On]. (see page 83)

[Set up timer] - submenu screen

Setting Example

Program 1, Every Monday, 12:00,

Power On, Input: HDMI1

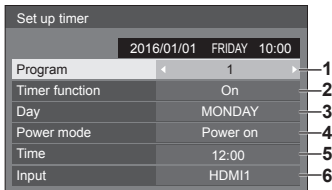

- 1 Set the program number.
- 2 To execute the program, set to [On].
The program is disabled when [Off] is set.
- 3 Set the day.
The program is executed every day when [Everyday] is set.
- 4 Set the power On/Off.
- 5 Set the time.
Pressing ◀▶ once changes time 1 minute.
Pressing continuously changes time by 15 minutes.
- 6 Set the input.

USB media player settings

Set for USB media player function.

[USB media player settings] - submenu screen

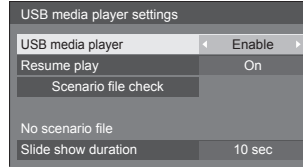

■ [USB media player]

Set to enable or disable the USB media player function.

■ [Resume play]

Set resume play off/on.

■ [Scenario file check]

Execute the contents check of the USB memory which is connected to the USB terminal. If any error is detected, the error code and file name will be displayed.

For details of the error codes, refer to "USB memory contents check". (see page 105)

Select [Scenario file check] with ▲ ▼ and press <ENTER>.

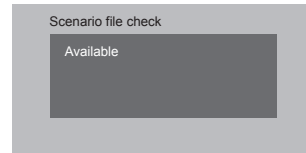

■ [Slide show duration]

Select the displaying duration for still images.
[10 sec] to [600 sec]

Function button settings

Assigns specific functions to the numeric buttons (<1> to <6>). The buttons can be used as shortcut keys by assigning frequently used operations.

1 Switch [Function group] with ◀▶.

[Function button settings] - submenu screen

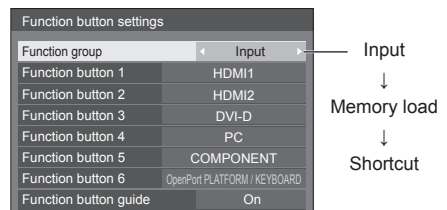

2 Select the numeric button with ▲▼ and set the function to assign with ▶◀.

■ Functions assignable to the numeric buttons

[Input] (Direct input select)

Input can be selected with single-touch operation.

[OpenPort PLATFORM] / [HDMI1] / [HDMI2] / [DVI-D] / [PC] / [COMPONENT]* / [VIDEO] / [USB]

*: [COMPONENT] may be displayed as [RGB] depending on the settings of [Component/RGB-in select]. (see page 78)

- Button <6> already has functions to select the OpenPort PLATFORM input with single-touch operation and display the software keyboard (see page 43) during the OpenPort PLATFORM input. This setting cannot be changed.

[Memory load]

Memory can be loaded with single-touch operation. Memory load (see page 75)

[MEMORY 1] to [MEMORY 5]

- [MEMORY 1] to [MEMORY 5] load functions are already assigned to <1> to <5> respectively. These settings cannot be changed.

[KEYBOARD]

- Button <6> already has the function to display the software keyboard (see page 43) during the OpenPort PLATFORM input. No specific functions are assigned for inputs other than the OpenPort PLATFORM input. This setting cannot be changed.

[Shortcut]

[Signal], [Screensaver], [Set up timer], [Power management settings], [Multi display settings]

- Pressing the numeric button displays the menu screen. Pressing the button again exits the menu screen.

[AV mute]

- Pressing the numeric button mutes the audio and pictures.

To cancel, press any button on the remote control except the <Standby (ON/OFF) button>.

[Digital zoom]

- Switches to [Digital zoom] mode by pressing numeric buttons. (see page 65)

[KEYBOARD]

- Button <6> already has the function to display the software keyboard (see page 43) during the OpenPort PLATFORM input. No specific functions are assigned for inputs other than the OpenPort PLATFORM input. This setting cannot be changed.

Shipping condition

The following functions are assigned to the numeric buttons as factory default.

	[Input]	[Memory load]	[Shortcut]
1	HDMI1	MEMORY 1	[Signal]
2	HDMI2	MEMORY 2	[Screensaver]
3	DVI-D	MEMORY 3	[Set up timer]
4	PC	MEMORY 4	[Power management settings]
5	COMPONENT	MEMORY 5	[AV mute]
6	OpenPort PLATFORM / KEYBOARD	--- / KEYBOARD	--- / KEYBOARD

■ [Function button guide]

Sets the function display when numeric buttons are pressed. Set this for each function group.

[On]:

Displays the function list for the numeric buttons.

[Off]:

Does not display the function list. Operation starts when numeric buttons are pressed.

Note

- When <FUNCTION> is pressed, [Function button guide] will be displayed regardless of the [On] / [Off] settings.

■ To use shortcut (numeric buttons)

1 Press <FUNCTION> or <1> - <6>.

[Function button guide] will be displayed.

[Function button guide]: When [Off] is set, pressing the numeric button starts operation.

Example: Input

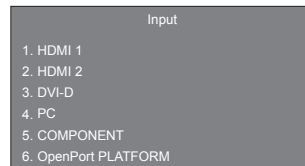

When using OpenPort PLATFORM input, number 6 will be [KEYBOARD].

2 Press <FUNCTION> to switch function group.

Example: Memory load

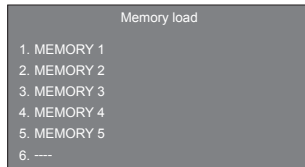

When using OpenPort PLATFORM input, number 6 will be [KEYBOARD].

3 Press <1> - <6>.

The function for the pressed button starts to operate.

Example: When <2> is pressed.

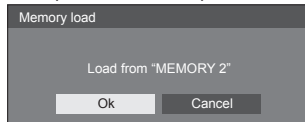

Display orientation

Sets the on-screen display orientation in the portrait setting.

[Landscape]:

On-screen display angle is for horizontal installation.

[Portrait]:

The on-screen display rotates anticlockwise by 90 degrees for easy view in the portrait setting.

When the setting is changed, a confirmation message to restart OpenPort PLATFORM is displayed.

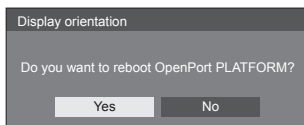

Select [Yes] with ◀ ▶ and press <ENTER> to restart. (Startup of OpenPort PLATFORM: see page 40)

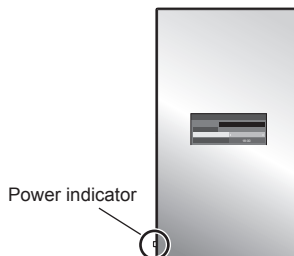

Note

- In the portrait setting, the power indicator shall come to the downside.
- The display may be greyed out and setting cannot be made in some conditions, such as when the OpenPort PLATFORM system is starting up.

OSD position

Sets the display position of the on-screen menu.

Each time ◀ or ▶ is pressed, the display position of the on-screen menu changes.

Display example:

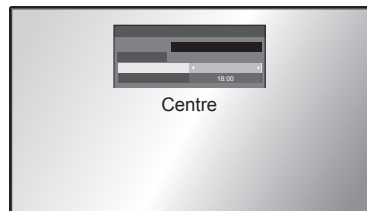
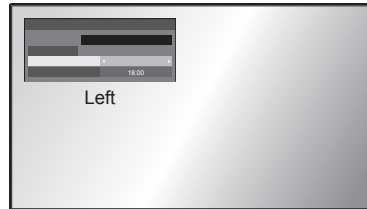

Note

- Display position settings vary depending on the setting of [Display orientation].

[Display orientation]: When it is set to [Landscape]

[Left] / [Centre] / [Right]

[Display orientation]: When it is set to [Portrait]

[Upper] / [Centre] / [Lower]

Menu display duration

Sets the display duration time for the on-screen menu.

[5 sec] to [180 sec]

Menu transparency

Sets the transparency rate of the on-screen display background.

0 to 100

Options Adjustments

This unit offers special functions conveniently used according to the installation location and application.

1 Press <SETUP>.

[Setup] menu screen will be displayed.

2 Select [OSD language] with ▲ ▼ and press <ENTER> for more than 3 seconds.

Following screen will be displayed.

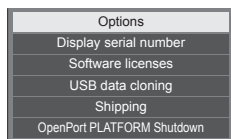

3 Select [Options] with ▲ ▼ and press <ENTER>.

[Options] menu screen will be displayed.

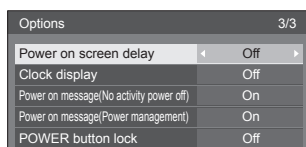
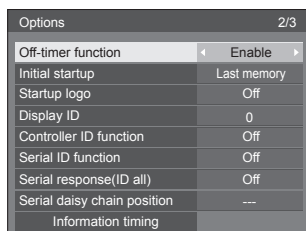
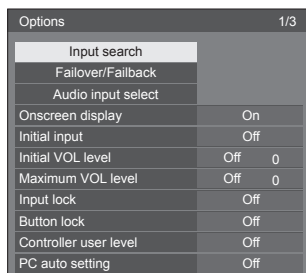

Note

- [POWER button lock] function is only for TH-55AF1U, TH-49AF1U and TH-42AF1U.

4 Select the item to set with ▲ ▼.

For [Input search], [Failover/Failback], [Audio input select] and [Information timing], the submenu screen will be displayed when you press <ENTER>.

(see page 89, 92, 95)

5 Set with ◀ ▶.

6 Press <SETUP> to exit from [Options] menu.

Note

- The remote control is necessary to display the [Options] menu. The control panel buttons on the main unit cannot be used to display the menu.
- Press <RETURN> to return to the previous menu.
- The serial number of this device is displayed when [Display serial number] is selected in step 3.
- The software License is displayed when [Software licenses] is selected in step 3.

Input search

When a signal is not detected, another input with a signal is automatically selected.

Note

- The OpenPort PLATFORM input is not a target of the "no signal" detection. It is excluded from this function.

Select the item with ▲ ▼.

Select the set point with ◀ ▶.

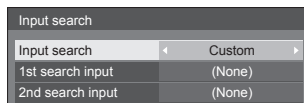

[Input search]

[Off]:

When there is no signal, the input is not switched automatically.

[All inputs]:

Searches all inputs except [OpenPort PLATFORM], and switches to an input with a signal.

Input search is executed in the following order.

(Example) When the current input is [HDMI1]

[HDMI2] → [DVI-D] → [PC] → [COMPONENT]* → [VIDEO] → [USB] → [HDMI1]

Note

- The inputs set to [(Skip)] in [Input label] (see page 81) are skipped when searching.
 - When Y/G/VIDEO terminal is used as VIDEO input, set [COMPONENT]* to [(Skip)].
- *: [COMPONENT] may be displayed as [RGB] depending on the settings of [Component/RGB-in select]. (see page 78)

[Custom]:

Repeatedly searches [Current input], [1st search input] and [2nd search input] in order, and switches to an input with a signal.

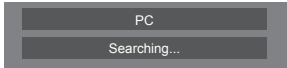

[Searching...] is displayed during the input search.

[1st search input], [2nd search input]

Set the input to search when [Custom] is selected.

[HDMI1] / [HDMI2] / [DVI-D] / [PC] / [COMPONENT]* / [VIDEO] / [USB] / (None)

- *: [COMPONENT] may be displayed as [RGB] depending on the settings of [Component/RGB-in select]. (see page 78)

Note

- With the USB input, the unit determines no signal is present when the USB memory is not connected to the USB terminal.
 - This menu will be greyed out and cannot be set under the following conditions.
 - [Input lock] is not set to [Off]. (see page 93)
 - [Failover/Failback] - [Input change mode] is not set to [Off]. (see page 89)
 - If the input is changed by this function, the last input is selected when the power is turned on next time.
- If you wish to retain the original input when the power is turned on, set [Initial input] to the original input. (see page 92)

Failover/Failback

Automatically switches to the backup input video if an interruption of video occurs.

1 Select the item with ▲ ▼.

Select the set point with ◀ ▶.

[Input change mode]

[Off]:

Disables the Backup Input function.

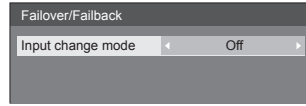

[Quick]:

Promptly switches to the backup input if an interruption of video occurs.

The backup video signal needs to be in the same format as the (main) input in use for viewing.

Upon switching to the backup input, the video and audio adjustment values for the (main) input used for viewing will be inherited.

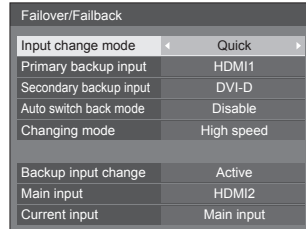

[Normal]:

Switches to the backup input if an interruption of video occurs.

The backup video signal does not need to be in the same format as the (main) input in use for viewing.

Upon switching to the backup input, the video and audio adjustment values for the backup input will be used.

■ [Input change mode]: [Quick]

Promptly switches to the backup input if an interruption of video occurs, and enables switching between digital (HDMI1 / HDMI2 / DVI-D) inputs.

Note

- The backup video signal needs to be in the same format as the (main) input in use for viewing.
- Upon switching to the backup input, the video and audio adjustment values for the (main) input used for viewing will be inherited.
- When switching from [Main input (except for OpenPort PLATFORM)] to [Backup Input OpenPort PLATFORM], the following functions take over operation as main input.
 - [No activity power off], main unit button operation
- This function will start operating once a video signal is detected by both the input in use for viewing and the backup input and the [Backup input change] item is displayed as [Active].

[Primary backup input]

Sets the first priority backup input.

(None) / [OpenPort PLATFORM] / [HDMI1] / [HDMI2] / [DVI-D]

The input that is of the same type as the one in use for viewing will be greyed out.

[Secondary backup input]

Sets the second priority backup input.

(None) / [OpenPort PLATFORM] / [HDMI1] / [HDMI2] / [DVI-D]

The input that is of the same type as the one in use for viewing will be greyed out.

[Auto switch back mode]

Sets whether or not to automatically return to the former (main) input when the former input video initially viewed is restored while viewing the video of the backup input enabled by the operation of the Backup Input function.

[Disable]:

Unreturned

[Enable]:

Returned

[Changing mode]

Select speed of input switching.

[High speed]:

If switching between the same signal formats, it is possible to switch within 1 second.

If switching between the different signal formats, picture noise is caused.

[Normal speed]:

If switching between the same signal formats, it is possible to switch within 2 seconds.

If switching between the different signal formats, it takes 3 to 4 seconds to switch but picture noise is not caused.

- The OpenPort PLATFORM input is treated as 1 125(1 080)/60p signal format equivalent.

[Backup input change]

Displays whether or not operating conditions for the Backup Input function are met.

[Inactive]:

Indicates that the conditions are not met, and inactivates the Backup Input function.

[Active]:

Indicates that the conditions are met, and activates the Backup Input function.

[Main input]

Displays the (main) input initially used for viewing.

[Current input]

Displays whether the input currently in use for viewing is the (main) input initially used for viewing or the backup one.

Setting conditions

The following table describes restrictions (available combinations) on each setting item.

		Backup		
		OpenPort PLATFORM HDMI1 HDMI2 DVI-D	PC COMPONENT* VIDEO	USB
Main	OpenPort PLATFORM	×	×	×
	HDMI1			
	HDMI2	○	×	×
	DVI-D			
	PC COMPONENT* VIDEO	×	×	×
	USB	×	×	×

○: Selectable for both Primary and Secondary.

×: Not selectable for neither Primary nor Secondary.

*: [COMPONENT] may be displayed as [RGB] depending on the settings of [Component/RGB-in select]. (see page 78)

Recall display

Pressing <RECALL> displays any of the followings.

- When the main input is being used for viewing and the operating conditions for the Backup Input function are met.

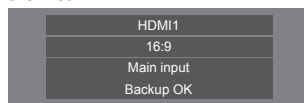

- When the backup input, enabled by the operation of the Backup Input function, is being used for viewing.

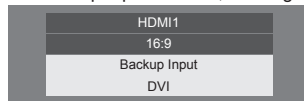

When the conditions for the Backup Input function are met, the following screen is displayed.

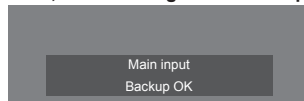

■ [Input change mode]: [Normal]

Switches to the backup input if an interruption of video occurs.

Note

- When an analogue (PC, COMPONENT or VIDEO) input is being used for viewing, you cannot set an analogue (PC, COMPONENT or VIDEO) input as a backup input.
- Any analogue (PC, COMPONENT or VIDEO) input cannot be set as [Primary backup input] or [Secondary backup input].
- This function will start operating once a video signal is detected by both the input in use for viewing and the backup input and the [Backup input change] item is displayed as [Active].

[Primary backup input]

Sets the first priority backup input.

(None) / [OpenPort PLATFORM] / [HDMI1] / [HDMI2] / [DVI-D] / [PC] / [COMPONENT]* / [VIDEO] / [USB]

The input that is of the same type as the one in use for viewing will be greyed out.

When an analogue (PC, COMPONENT or VIDEO) input is being used for viewing, you cannot set an analogue (PC, COMPONENT or VIDEO) input as a backup input.

Any analogue (PC, COMPONENT or VIDEO) input cannot be set as [Primary backup input] or [Secondary backup input].

[Secondary backup input]

Sets the second priority backup input.

(None) / [OpenPort PLATFORM] / [HDMI1] / [HDMI2] / [DVI-D] / [PC] / [COMPONENT]* / [VIDEO] / [USB]

The input that is of the same type as the one in use for viewing will be greyed out.

When an analogue (PC, COMPONENT or VIDEO) input is being used for viewing, you cannot set an analogue (PC, COMPONENT or VIDEO) input as a backup input.

Any analogue (PC, COMPONENT or VIDEO) input cannot be set as [Primary backup input] or [Secondary backup input].

[Auto switch back mode]

Sets whether or not to automatically return to the former (main) input when the former input video initially viewed is restored while viewing the video of the backup input enabled by the operation of the Backup Input function.

[Disable]:

Unreturned

[Enable]:

Returned

[Backup input change]

Displays whether or not operating conditions for the Backup Input function are met.

[Inactive]:

Indicates that the conditions are not met, and inactivates the Backup Input function.

[Active]:

Indicates that the conditions are met, and activates the Backup Input function.

[Main input]

Displays the (main) input initially used for viewing.

[Current input]

Displays whether the input currently in use for viewing is the (main) input initially used for viewing or the backup one.

*: [COMPONENT] may be displayed as [RGB] depending on the settings of [Component/RGB-in select]. (see page 78)

Setting conditions

The following table describes restrictions (available combinations) on each setting item.

		Backup		
		OpenPort PLATFORM HDMI1 HDMI2 DVI-D	PC COMPONENT* VIDEO	USB
Main	OpenPort PLATFORM	×	×	×
	HDMI1			
	HDMI2	○	△	○
	DVI-D			
	PC COMPONENT*	○	×	○
	VIDEO			
USB	○	△	×	

○: Selectable for both Primary and Secondary.

△: Selectable for either Primary or Secondary.

×: Not selectable for neither Primary nor Secondary.

*: [COMPONENT] may be displayed as [RGB] depending on the settings of [Component/RGB-in select]. (see page 78)

Recall display

Pressing <RECALL> displays any of the followings.

- When the main input is being used for viewing and the operating conditions for the Backup Input function are met.

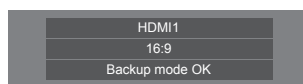

- When the backup input, enabled by the operation of the Backup Input function, is being used for viewing.

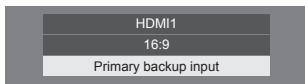

When the conditions for the Backup Input function are met, the following screen is displayed.

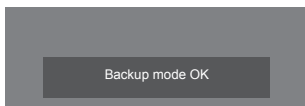

Note

- This menu will be greyed out and cannot be set under the following conditions.
 - [Input lock] is set to [OpenPort PLATFORM]. (see page 93)
 - [Input search] is set to the item other than [Off]. (see page 88)
- With the USB input, the unit determines video signals are interrupted by judging the USB memory is not connected to the USB terminal.

Audio input select

Set up the sound when a video input is selected.

1 Select the video input with ▲▼.

Set the audio input with ◀▶.

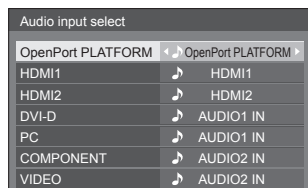

- The illustration above shows the factory settings.

Video input	Audio input
OpenPort PLATFORM	OpenPort PLATFORM / AUDIO1 IN / AUDIO2 IN / No audio
HDMI1	HDMI1 / AUDIO1 IN / AUDIO2 IN / No audio
HDMI2	HDMI2 / AUDIO1 IN / AUDIO2 IN / No audio
DVI-D / PC / COMPONENT* / VIDEO	AUDIO1 IN / AUDIO2 IN / No audio

No audio: No audio input (Mute)

*: [COMPONENT] may be displayed as [RGB] depending on the settings of [Component/RGB-in select]. (see page 78)

When the setting for the audio input has been changed from the factory settings, the audio input is displayed as below.

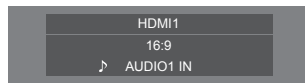

Onscreen display

Set to display / hide the following Onscreen display.

- Power on display
- Input signal switch display
- No signal display
- No external media display (at USB input)
- MUTE display after displaying the menu screen
- Off timer remaining time display when 3 minutes remaining

[On]:

Displays the Onscreen display.

[Off]:

Hides the Onscreen display.

Initial input

Adjusts the input signal when the unit is turned on.

[Off] / [OpenPort PLATFORM] / [HDMI1] / [HDMI2] / [DVI-D] / [PC] / [COMPONENT]* / [VIDEO] / [USB]

*: [COMPONENT] may be displayed as [RGB] depending on the settings of [Component/RGB-in select]. (see page 78)

Note

This menu is available only when [Input lock] is [Off]. (see page 93)

Initial VOL level

Adjusts the sound volume level when the unit is turned on.

[Off]:

It will be the sound volume level which had been set before the power of the unit was turned off.

[On]:

Sets your preferred volume.

- Outputs with the set volume when [Initial VOL level] in [On] state is selected on the menu.

■ To adjust sound volume level

Press <VOL +> <VOL ->.

Note

- When [Maximum VOL level] is [On], the volume cannot be set to the level higher than the level set for [Maximum VOL level].

Maximum VOL level

Adjusts the maximum volume.

[Off]:

The sound volume level can be set up to 100 (maximum).

[On]:

The sound volume level will not exceed the set point.

- Outputs with the set volume when [Maximum VOL level] in [On] state is selected on the menu.

■ To adjust sound volume level

Press <VOL +> <VOL ->.

Note

- When the [Maximum VOL level] is switched from [Off] to [On], if the [Maximum VOL level] is set lower than the [Initial VOL level], the [Initial VOL level] automatically becomes the same as the [Maximum VOL level].

Input lock

Locks the input switch operation.

[Off] / [OpenPort PLATFORM] / [HDMI1] / [HDMI2] / [DVI-D] / [PC] / [COMPONENT]* / [VIDEO] / [USB]

*: [COMPONENT] may be displayed as [RGB] depending on the settings of [Component/RGB-in select]. (see page 78)

Note

- Input switch can be used when this is set to [Off].

Button lock

Limits operation of the buttons on the unit.

[Off]:

All the buttons on main unit can be used.

[On]:

All button operations except for the <Main Power On / Off button> are disabled.

[MENU & ENTER]:

Locks <MENU (Unit)> and <ENTER (Unit)> buttons.

■ To set [Button lock]

Set with the buttons on the unit.

[Off]:

- ① Press <+ (Unit)> for 4 times.
- ② Press <INPUT (Unit)> for 4 times.
- ③ Press <- (Unit)> for 4 times.
- ④ Press <ENTER (Unit)>.

[On]:

- ① Press <- (Unit)> for 4 times.
- ② Press <ENTER (Unit)> for 4 times.
- ③ Press <+ (Unit)> for 4 times.
- ④ Press <ENTER (Unit)>.

[MENU & ENTER]:

- ① Press <ENTER (Unit)> for 4 times.
- ② Press <+ (Unit)> for 4 times.
- ③ Press <INPUT (Unit)> for 4 times.
- ④ Press <ENTER (Unit)>.

Controller user level

Limits operation of the buttons on the remote control.

[Off]:

You can use all of the buttons on the remote control.

[User1]:

You can only use <Standby (ON/OFF) button>, <INPUT>, <RECALL>, <MUTE>, <VOL +> and <VOL -> buttons on the remote control.

[User2]:

You can only use <Standby (ON/OFF) button> on the remote control.

[User3]:

Locks all the buttons on the remote control.

PC auto setting

Sets the operational mode of the automatic position adjustment in the [Position] menu.

[Off]:

Automatic position adjustment starts when <AUTO SETUP> is pressed on the remote control or automatic position adjustment is executed from the [Position] menu.

[On]:

Other than remote control or menu operation, automatic position adjustment starts:

- When the display power is turned ON.
- When the input signal is switched.

Off-timer function

Enables / disables Off timer function.

[Enable]:

Enables the [Off-timer function].

[Disable]:

Disables the [Off-timer function].

Note

- When [Disable] is set, the Off-timer is cancelled.

Initial startup

Sets the power mode of the unit for when the power recovers from failure or after plugging off and in again.

[Last memory]:

Power returns in as the same state as before the power interruption.

[On]:

Power returns in power On.
(Power Indicator: green)

[Standby]:

Power returns in standby mode.
(Power Indicator: red/orange)

Note

- When using multiple displays, [Standby] is preferred to be set in order to reduce a power load.

Startup logo

Sets to display / not to display the Panasonic logo on the screen when the display is turned on.

[Off]:

Panasonic logo is not displayed.

[On]:

Panasonic logo is displayed.

Note

- For the OpenPort PLATFORM startup screen, see page 40.

Display ID

Sets ID number when controlling the Display with [Controller ID function] and [Serial ID function].

0 - 100 (Standard value: 0)

Controller ID function

Enables/Disables the ID remote control function.

To operate this function, please purchase ID remote controller sold separately. (see page 109)

[Off]:

Disables the ID remote control function. (Can be operated as normal remote control.)

[On]:

Enables the ID remote control function.
Effective on switching to [On].

Note

- To use the ID remote control function, setting ID numbers both for the remote control and for the display unit is required.

For ID number setting for the remote control and display unit, see page 109 and [Display ID] respectively.

Serial ID function

Set to control external control with the PC connected to SERIAL terminal according to the Display's ID number (Panel ID).

[Off]:

Disables external control by the ID.

[On]:

Enables the external control by the ID.

Serial response(ID all)

Sets whether to respond to the command or not, when serial command of ID No "0" is received.

[Off]:

Does not respond.

[On]:

Responds.

Serial daisy chain position

Set the first and last terminals in the chain when the SERIAL IN/OUT terminal of this unit is connected using a daisy chain scheme.

[--]:

When controlling this unit alone with serial control, or connecting at a position other than the first and last terminals in a daisy chain

[Top]:

When connecting at the first terminal in a daisy chain

[End]:

When connecting at the last terminal in a daisy chain

Information timing

Set up the informing manner for no signal or temperature rising.

During RS-232C controls:

Warning or error message sent on the display automatically.

During LAN controls:

Acquire the warning or error message from the display.

1 Select the item with ▲▼.

Select the set point with ◀▶.

Information timing	
No signal warning	On
No signal warning timing	5min
No signal error	On
No signal error timing	10min
Temperature warning	On

[No signal warning]

When set to [On], the display sends out the no signal warning.

[No signal warning timing]

Set up the detecting time for no signal warning.
(Range: 01 - 60, Interval: 1 minute)

[No signal error]

When set to [On], the display sends out the no signal error.

[No signal error timing]

Set up the detecting time for no signal error.
(Range: 01 - 90, Interval: 1 minute)

- The warning of [No signal warning] and the error of [No signal error] are not sent when the no signal state is detected through any of the following functions:

[No signal power off], [HDMI1 power management], [HDMI2 power management], [DVI-D power management], [PC power management] (see page 81)

Setting Example:

[No signal warning timing]: 5 minutes

[No signal error timing]: 10 minutes

Note

- The [No signal error timing] cannot be set shorter than [No signal warning timing].

[Temperature warning]

When set to [On], the display sends out the warning message.

Note

- With the USB input, the unit determines video signals are interrupted by judging the USB memory is not connected to the USB terminal.

Power on screen delay

You can set the power-on delay time of the displays to reduce the power load, when you press <Main Power On / Off button> to turn on the multiple displays that are set together.

Set each display's setting individually.

[Off]:

The display will be turned on at the same time as <Main Power On / Off button> is pressed.

[Auto]:

Sets the delay time automatically according to the number set for [Display ID].

The delay time is determined by multiplying [Display ID] × 0.3 seconds.

Example:

When [Display ID] is 3 → 0.9 seconds

1 to 30:

Set the power-on delay time (second).

After pressing <Main Power On / Off button>, the display will be powered on with time delay depending on this setting.

Note

- While this function is working, the power indicator is blinking green.
- This function also works when the power recovers from failure or after plugging off and in again the power cord.
- Even if [OpenPort PLATFORM standby] (see page 83) is set to [On], when starting up in standby status where the power indicator is off or illuminating in red, OpenPort PLATFORM has not started yet while operating with startup delay. Therefore, if the power is turned off using the remote control during this time, the unit enters the standby mode with the power indicator illuminating in red.

Clock display

Sets to display / hide the clock.

[Off]:

Hides the clock.

[On]:

Displays the clock.

Note

- The clock is displayed at the lower left of the screen when <RECALL> button is pressed.
- When current date and time is not set, the clock is not displayed even when [Clock display] is [On]. (see page 59)

Power on message(No activity power off)

Sets to show/hide [No activity power off] precautions at the time the unit is turned on.

[On]:

The warning precautions are shown at the time of power ON.

[Off]:

The warning precautions are not shown at the time of power ON.

Note

- This setting is enabled only when [No activity power off] is [Enable] (see page 83).
- The warning precautions are not shown when OpenPort PLATFORM input is used at the time of power ON.

Power on message(Power management)

Whether to show/hide an information message that tells the power has been turned off by "Power management" function when the power is set to [On].

[On]:

The information is shown at the time of power [On].

[Off]:

The information is not shown at the time of power [On].

Note

- This setting is enabled only when "Power management" function is [On] (see page 81).

POWER button lock

Sets the lock setting for the display <Main Power On / Off button>.

[On]:

<Main Power On / Off button> operation is disabled.

[Off]:

<Main Power On / Off button> operation is enabled.

Note

- This function is only for TH-55AF1U, TH-49AF1U and TH-42AF1U.

Initialization

When both main unit buttons and remote control buttons are disabled due to the [Button lock], [Controller user level] and [Controller ID function] settings, set all the values [Off] so that all the buttons are enabled again.

Press <- (Unit)> together with <RETURN> and hold for more than 5 seconds.

[Shipping] is displayed and the lock is released when it disappears.

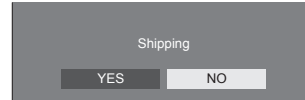

- Settings for [Button lock], [Controller user level] and [Controller ID function] will be back to [Off].

Using Network Function

This unit has a network function and you can control the Display connected to the network using your computer.

With OpenPort PLATFORM input, it is also possible to display WEB pages, download applications from the server, etc.

Necessary environment for computers to be connected

First of all, confirm your computer whether it has a wired LAN or a built-in wireless LAN.

Before connecting the Display to the computer, be sure to check the following settings.

The requirements described here do not guarantee proper operation of all wireless LAN adapters or wireless LAN adapters incorporated in PCs.

■ For wired LAN

Check 1: About LAN cable

- Connect the cable properly.
- Use LAN cable that is compatible with category 5 or above. To connect a device using 1000BASE-T, use LAN cable that is compatible with category 5e or above.

Check 2: Wired LAN settings

Computer with a built-in wired LAN function

- Switch on the wired LAN.

Computer without a built-in wired LAN function

- Check that your wired LAN adapter is recognized properly and it is switched on.
- Install the wired LAN adapter driver beforehand.

For details on how to install the driver, refer to the instructions accompanying the wired LAN adapter.

■ For wireless LAN

Check 1: Wireless LAN settings

Computer with a built-in wireless LAN function

- Switch on the wireless LAN.

Computer without a built-in wireless LAN function

- Check that your wireless LAN adapter is recognized properly and it is switched on.
- Install the wireless LAN adapter driver beforehand.

For details on how to install the driver, refer to the instructions accompanying the wireless LAN adapter.

Check 2: PC

- If the security (firewall) software or utility software of network card has been installed, connection to the display may not be possible.
- Do not set the network bridge.
- Disable the firewall.

Example of network connection

Note

- To use the network function, set each item in [WIRELESS & NETWORKS] in OpenPort PLATFORM. (see page 55)
- To control the display connected to the network using your computer, set each item in [LAN Control] in OpenPort PLATFORM (see page 54) and make sure to set [Command Control] to [ON].

To enable startup from the wired LAN or wireless LAN in standby mode, set [OpenPort PLATFORM standby] to [On]. (see page 83)

When it is set to [On], power indicator lights orange under the condition of power "Off" with remote control (stand-by state).

■ LAN Terminal connection

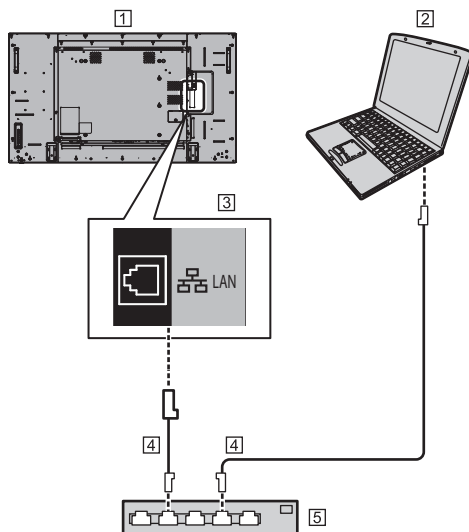

① Display (Back of the unit)

② PC

③ LAN Terminal

④ LAN cable (commercially available)

⑤ Hub or broadband router

Note

- For LAN cable, use shielded cable, otherwise picture noise may be caused.
- Make sure the broadband router or hub supports 10BASE-T/100BASE-TX/1000BASE-T.
- In the network condition where both the wired LAN and wireless LAN operate, the wired LAN is prioritized for operation. When using the wireless LAN, disconnect the wired LAN cable.

- Touching the LAN Terminal with a statically charged hand (body) may cause damage to the device due to its discharge.

Do not touch the LAN Terminal or the metal part of the LAN cable.

- For instructions on connection, consult your network administrator.

Command control

Network function of the unit can control the unit in the same way as serial control from a network.

Supported commands

Commands used in the serial control are supported. (see page 27)

Control Command via LAN

The communication differs whether [LAN Control] - [Control Protocol] in OpenPort PLATFORM is set to [Protocol1] or [Protocol2].

1. When [Control Protocol] is set to [Protocol1].

Communicates using the display-specific protocol.

■ When the command control administrator privileges password has been set (Protect mode)

Connection method

- 1 Obtain the display's IP address and the port number (Default is 1024), and request connection to the display.

The IP address and the port number can be obtained from the following menus.

- IP address:
[STATUS] in OpenPort PLATFORM (see page 52) or [WIRELESS & NETWORKS] (see page 55)
- Port number:
[LAN Control] in OpenPort PLATFORM (see page 54)

- 2 The display responds.

Response data

Data part	Space	Mode	Space	Random number part	Last terminal symbol
[PDPCONTROL] (ASCII character string)	[] 0x20	[1] 0x31	[] 0x20	[zzzzzzz] (ASCII code hex number)	(CR) 0x0d
10 bytes	1 byte	1 byte	1 byte	8 bytes	1 byte

Mode:1 = Protect mode

- 3 Hash the following data with the MD5 algorithm, and generate a 32-byte hash value.

[zzzzzzzzyyyyyy]

zzzzzzzz :

8-byte random number obtained in step 2

yyyyyy :

Command control administrator privileges user

- Default user name and password are as follows:

User name: admin1

Password: panasonic

Command transmission method

Transmit in the following command format

Transmitted data

Header	Control symbol	Data part	Control symbol	Last terminal symbol
Hash value (see "Connection method")	(STX) 0x02	Control command (ASCII character string)	(ETX) 0x03	(CR) 0x0d
32 bytes	1 byte	Undefined	1 byte	1 byte

Received data

Control symbol	Data part	Control symbol	Last terminal symbol
(STX) 0x02	Control command (ASCII character string)	(ETX) 0x03	(CR) 0x0d
1 byte	Undefined	1 byte	1 byte

Error response

Error message	Last terminal symbol
"ERR1" : Undefined control command	(CR) 0x0d
"ERR2" : Out of parameter range	
"ERR3" : Busy status or reception invalid period	
"ERR4" : Timeout or reception invalid period	
"ERR5" : Wrong data length	
"PDPCONTROL ERRA" : Mismatching of password	(CR) 0x0d
4 bytes or 15 bytes	

■ When the command control administrator privileges password has not been set (Non-protect mode)

Connection method

1 Obtain the display's IP address and the port number (Default is 1024), and request connection to the display.

The IP address and the port number can be obtained from the following menus.

- IP address:
[STATUS] in OpenPort PLATFORM (see page 52) or [WIRELESS & NETWORKS] (see page 55)
- Port number:
[LAN Control] in OpenPort PLATFORM (see page 54)

2 The display responds.

Response data

Data part	Space	Mode	Last terminal symbol
[PDPCONTROL] (ASCII character string)	[] 0x20	[0] 0x30	(CR) 0x0d
10 bytes	1 byte	1 byte	1 byte

Mode:0 = Non-protect mode

Command transmission method

Transmit in the following command format

Transmitted data

Control symbol	Data part	Control symbol	Last terminal symbol
(STX) 0x02	Control command (ASCII character string)	(ETX) 0x03	(CR) 0x0d
1 byte	Undefined	1 byte	1 byte

Received data

Control symbol	Data part	Control symbol	Last terminal symbol
(STX) 0x02	Control command (ASCII character string)	(ETX) 0x03	(CR) 0x0d
1 byte	Undefined	1 byte	1 byte

Error response

Error message	Last terminal symbol
“ERR1” : Undefined control command	(CR) 0x0d
“ERR2” : Out of parameter range	
“ERR3” : Busy status or reception invalid period	
“ERR4” : Timeout or reception invalid period	
“ERR5” : Wrong data length	
4 bytes	1 byte

2. When [Control Protocol] is set to [Protocol2].

Communicates with the same protocol as that of a Panasonic projector

■ When the command control administrator privileges password has been set (Protect mode)

Connection method

1 Obtain the display's IP address and the port number (Default is 1024), and request connection to the display.

The IP address and the port number can be obtained from the following menus.

- IP address:
[STATUS] in OpenPort PLATFORM (see page 52) or [WIRELESS & NETWORKS] (see page 55)
- Port number:
[LAN Control] in OpenPort PLATFORM (see page 54)

2 The display responds.

Response data

Data part	Space	Mode	Space	Random number part	Last terminal symbol
[INTCONTROL] (ASCII character string)	[] 0x20	[1] 0x31	[] 0x20	[zzzzzzz] (ASCII code hex number)	(CR) 0x0d
9 bytes	1 byte	1 byte	1 byte	8 bytes	1 byte

Mode: 1 = Protect mode

- 3 Hash the following data with the MD5 algorithm, and generate a 32-byte hash value.

[xxxxxx:yyyyy:zzzzzzzz]

xxxxxx :

Command control administrator privileges user name

yyyyy :

Above administrator privileges user password

- Default user name and password are as follows:

User name: admin1

Password: panasonic

zzzzzzzz :

8-byte random number obtained in step 2

Command transmission method

Transmit in the following command format

Transmitted data

Header			Data part	Last terminal symbol
Hash value (see "Connection method")	'0' 0x30	'0' 0x30	Control command (ASCII character string)	(CR) 0x0d
32 bytes	1 byte	1 byte	Undefined	1 byte

Received data

Header		Data part	Last terminal symbol
'0' 0x30	'0' 0x30	Control command (ASCII character string)	(CR) 0x0d
1 byte	1 byte	Undefined	1 byte

Error response

Error message	Last terminal symbol
"ERR1" : Undefined control command	(CR) 0x0d
"ERR2" : Out of parameter range	
"ERR3" : Busy status or reception invalid period	
"ERR4" : Timeout or reception invalid period	
"ERR5" : Wrong data length	
"ERRA" : Mismatching of password	
4 bytes	1 byte

■ When the command control administrator privileges password has not been set (Non-protect mode)

Connection method

- 1 Obtain the display's IP address and the port number (Default is 1024), and request connection to the display.

The IP address and the port number can be obtained from the following menus.

- IP address:
[STATUS] in OpenPort PLATFORM (see page 52)
or [WIRELESS & NETWORKS] (see page 55)
- Port number:
[LAN Control] in OpenPort PLATFORM (see page 54)

- 2 The display responds.

Response data

Data part	Space	Mode	Last terminal symbol
[NTCONTROL] (ASCII character string)	[] 0x20	[0] 0x30	(CR) 0x0d
9 bytes	1 byte	1 byte	1 byte

Mode: 0 = Non-protect mode

Command transmission method

Transmit in the following command format

Transmitted data

Header		Data part	Last terminal symbol
'0' 0x30	'0' 0x30	Control command (ASCII character string)	(CR) 0x0d
1 byte	1 byte	Undefined	1 byte

Received data

Header		Data part	Last terminal symbol
'0' 0x30	'0' 0x30	Control command (ASCII character string)	(CR) 0x0d
1 byte	1 byte	Undefined	1 byte

Error response

Error message	Last terminal symbol
"ERR1" : Undefined control command	(CR) 0x0d
"ERR2" : Out of parameter range	
"ERR3" : Busy status or reception invalid period	
"ERR4" : Timeout or reception invalid period	
"ERR5" : Wrong data length	
4 bytes	1 byte

PJLink protocol

The unit's Network function is compatible with PJLink Class 1. The following operations can be performed from a computer when PJLink protocol is used.

- Setting the Display
- Querying the Display status

Supported commands

The commands to control the unit with PJLink protocol are as follows.

Command	Control
POWR	Power control 0: Standby 1: Power On
POWR?	Power status query 0: Standby 1: Power On
INPT	Input switch 11: PC IN input (PC) 21: COMPONENT/RGB IN input (COMPONENT) 22: VIDEO input (VIDEO) 31: OpenPort PLATFORM input (OpenPort PLATFORM) 32: HDMI 1 input (HDMI1) 33: HDMI 2 input (HDMI2) 34: DVI-D IN input (DVI-D) 41: USB input (USB)
INPT?	Input switch query 11: PC IN input (PC) 21: COMPONENT/RGB IN input (COMPONENT) 22: VIDEO input (VIDEO) 31: OpenPort PLATFORM input (OpenPort PLATFORM) 32: HDMI 1 input (HDMI1) 33: HDMI 2 input (HDMI2) 34: DVI-D IN input (DVI-D) 41: USB input (USB)
AVMT	Shutter control 10: Picture On (picture mute deactivated) 11: Picture Off (picture on mute) 20: Audio On (audio mute deactivated) 21: Audio Off (audio on mute) 30: Shutter mode Off (picture and audio mute deactivated) 31: Shutter mode On (picture and audio on mute)
AVMT?	Shutter control query 11: Picture Off (picture on mute) 21: Audio Off (audio on mute) 30: Shutter mode Off (picture and audio mute deactivated) 31: Shutter mode On (picture and audio on mute)

Command	Control
ERST?	Error status query First byte: 0 Second byte: 0 Third byte: 0 Fourth byte: 0 Fifth byte: 0 Sixth byte: Other error. 0 or 2. <ul style="list-style-type: none"> Meaning of 0, 2. 0: Error is not detected, 2: Error
LAMP?	Lamp status query Not supported
INST?	Input switch list query 11: PC IN input (PC) 21: COMPONENT/RGB IN input (COMPONENT) 22: VIDEO input (VIDEO) 31: OpenPort PLATFORM input (OpenPort PLATFORM) 32: HDMI 1 input (HDMI1) 33: HDMI 2 input (HDMI2) 34: DVI-D IN input (DVI-D) 41: USB input (USB)
NAME?	Display name query Returns settings detail of [LAN Control] - [Display name] in OpenPort PLATFORM.
INF1?	Manufacturer name query Returns "Panasonic".
INF2?	Model name query Returns "55AF1U". (Example: 55-inch AF1U model) Returns "55AF1W". (Example: 55-inch AF1W model)
INFO?	Other information query Returns version number.
CLSS?	Class information query Returns "1".

PJLink security authentication

The password used for PJLink is the same as the password set in [LAN Control] in OpenPort PLATFORM. (see page 54)

When using PJLink without security authorization, set use without the password in [LAN Control] in OpenPort PLATFORM.

- Concerning the specification of PJLink, see the web site of Japan Business Machine and Information System Industries Association (JBMA) below:

<http://pjlink.jbma.or.jp/english/index.html>

Early Warning Software

This unit supports "Early Warning Software" which monitors the statuses of devices (projectors or flat-panel displays) connected to an intranet, reports failures of devices and gives advance warning by detecting a predicted abnormality.

The maximum number of devices that can be registered to monitor differs according to the type of license. Up to 2048 devices can be registered and used for free for a maximum of 90 days after the installation to PC has completed.

- For more details, visit the following web site.

<http://panasonic.net/prodisplays/products/et-swa100/index.html>

Note

- This unit does not support WEB control function.

Multi Monitoring & Control Software

This unit supports "Multi Monitoring & Control Software" which monitors and controls devices (projectors or flat-panel displays) connected to an intranet.

For details, see the following website.

<http://panasonic.net/prodisplays/download/software/index.html>

Note

- This unit is not compatible with WEB control function or content list distribution function.

USB Media Player

Function description

The USB media player displays still pictures and motion pictures saved in a USB memory by inserting the USB memory device into the USB terminal at the bottom of the display unit.

Note

- To use this function, set [USB media player] to [Enable] in [Setup] - [USB media player settings]. (see page 85)

Single Media Player

Files are played by a single unit.



USB memory

Note

- This unit does not support Multi Media Player.
- Pictures in the USB memory cannot be displayed via a daisy chain connection with the DVI-D IN/OUT terminal.

Preparation

Supported device

- Commercially available USB memory devices are supported. (Those with security functions are not supported.)
- USB memory devices other than those formatted in FAT16 or FAT32 cannot be used.
- Up to 32 GB of USB memory in size are supported.
- Only single partition configuration is supported.

Preparation

Prepare the following files in the USB memory for the media player.

- Play file
- Scenario (as necessary)
- File list (as necessary)

Play file

The unit's Media Player supports the formats below.

File name (Extension)

Still image	JPG, JPEG, JPE
Moving image	AVI, MKV, ASF, WMV, TS, MTS, MP4, 3GP, MOV, FLV, F4V

Codec

Moving image

Codec	Maximum resolution
MPEG4VISUAL	480@30fps
MPEG4AVC	1080@30fps, High Profile
VC-1 Advanced	1080@30fps
VC-1 Simple & Main	1080@30fps

Audio

Codec	Sampling frequency (kHz)	Bit rate (kbps)
MP3	8/11.025/12/16/22.05/24/32/44.1/48	8-320
AAC	8/11.025/12/16/22.05/24/32/44.1/48	1-1728
WMA Standard WMA 9 WMA 10 Pro	8/11.025/12/16/22.05/24/32/44.1/48	1-1728

Still image

Codec	Maximum resolution
JPEG	4096×4096

Note

- Maximum size per one file is 2 GB.
- Files protected by Digital Rights Management (DRM) cannot be played back.
- Some files may not be played back even if their formats are supported as described here.
- Use a file of which audio and video are both supported.
- If the audio codec of motion picture file is incompatible in format, the pictures may not be correctly displayed.
- If there is no video file, playback is not possible.

■ Scenario

The play order and time can be specified for a play file.

Save under the name (one-byte alphabetical characters) "scenario.dat" immediately below root in USB memory.

- Save files as UTF-8N format.

■ File list

It is a list of play files.

Save under the name (one-byte alphabetical characters) "filelist.dat" immediately below root in USB memory.

- Save files as UTF-8N format.

■ Scenario- / File list-associated terms

File name

It is the name of a play file.

A file name needs to include its extension.

Example:

```
introduction.jpg  
Contents_video01.wmv
```

- Enter the extension of a file name using one-byte alphanumeric characters.

File definition

It is a file definition that is shared among scenarios and files.

```
PHOTO_xxx: still image file definition  
VIDEO_xxx: moving image file definition
```

- The "xxx" portion can be set from 001 to 999.
- Enter a file definition using one-byte alphanumeric characters.

Play time

It is the play time of a file.

Play time can be specified from 3 seconds to 24 hours. (Unit: second)

Example:

```
10: 10 seconds  
86400: 24 hours  
10.5: 10.5 seconds
```

It can be set down to one-tenth (1/10) of a second using a decimal point (full stop).

Play time is omissible.

For still images, a file will be played for the period of time that you selected in [USB media player settings] - [Slide show duration]. (see page 85)

For moving images: a file will be played for the duration of the play time of the file.

- Enter play time using one-byte numeric characters.
- When playing back large sized files, if you set the playing back duration short, it may not be played back properly, for example, noise appears on the screen.

In that case, set the playing back duration longer (10 seconds or longer).

Note

- "UTF-8N": UTF-8 encoding without BOM. Notepad for windows doesn't support this encoding.

Please use another editor supported UTF-8 encoding without BOM.

Playing back the files

■ Example of setting in each mode

Single Media Player (Type 1)

Files will be played in the order in which their names appear in USB memory.

Scenario and file list

Scenario:

Unnecessary

File list:

Unnecessary

Setting example

USB memory contents

```
├─ 001_Introduction.jpg  
├─ 002_Contents_Video1.wmv  
├─ 003_Contents_Video2.wmv  
├─ 004_Contents_Video3.wmv
```

Play contents

For the above setting example, the following contents will be played on repeat (loop).

1. 001_Introduction.jpg (*1)
2. 002_Contents_Video1.wmv (*2)
3. 003_Contents_Video2.wmv (*2)
4. 004_Contents_Video3.wmv (*2)

*1: Played for the duration set in [Slide show duration].

*2: Played for the duration of the play time of the file.

Single Media Player (Type 2)

Files will be played in the order they were listed in a scenario.

Scenario and file list

Scenario:

Enter [File name: Play time].

File list:

Unnecessary

Setting example

USB memory contents

```
├ scenario.dat
├ Introduction.jpg
├ Contents_Video1.wmv
├ Contents_Video2.wmv
├ Contents_Video3.wmv
```

scenario.dat (scenario)

```
Introduction.jpg:10
Contents_Video1.wmv:10
Contents_Video2.wmv:20
Contents_Video3.wmv:
```

Play contents

For the above setting example, the following contents will be played on repeat (loop).

1. Introduction.jpg (10 seconds)
2. Contents_Video1.wmv (10 seconds)
3. Contents_Video2.wmv (20 seconds)
4. Contents_Video3.wmv (Played for the duration of the play time of the file)

Single Media Player (Type 3)

Files will be played in the order they were listed in a scenario.

Scenario and file list

Scenario:

Enter [File definition: Play time].

File list:

Enter [File definition: File name].

Setting example

USB memory contents

```
├ filelist.dat
├ scenario.dat
├ Introduction.jpg
├ Contents_Video1.wmv
├ Contents_Video2.wmv
├ Contents_Video3.wmv
```

scenario.dat (scenario)

```
PHOTO_001:10
VIDEO_001:10
VIDEO_002:20
VIDEO_003:
```

filelist.dat (file list)

```
PHOTO_001:Introduction.jpg
VIDEO_001:Contents_Video1.wmv
VIDEO_002:Contents_Video2.wmv
VIDEO_003:Contents_Video3.wmv
```

Play contents

For the above setting example, the following contents will be played on repeat (loop).

1. Introduction.jpg (10 seconds)
2. Contents_Video1.wmv (10 seconds)
3. Contents_Video2.wmv (20 seconds)
4. Contents_Video3.wmv (Played for the duration of the play time of the file)

Note

- While the menu screen is not displayed, you can skip to the next playback file with ►, to the previous playback file with ◀, or play back again from the beginning of the file with ▼ (Remote control operation only).
- [Multi display settings] supports 2×1, 1×2 and 2×2. (see page 84)

■ USB memory contents check

You can run a USB memory contents check in [USB media player settings] - [Scenario file check]. (see page 85)

If an error is present, the information is given with the following details.

A(B): C

D

A: Name of the file with an error

B: Row with an error

C: Error code

D: Detail of the error

Note

- Shows leading error codes.

Details of the detected errors are as follows.

Error code	Detail of the error
1.	No USB memory is inserted.
2.	scenario.dat/filelist.dat cannot be opened.
3.	There is an error in the contents of scenario.dat/filelist.dat.
4.	The play file format is not supported.
5.	No play file exists.
7.	There are several identical file definitions.
8.	The scenario's play time is over the limit.
9.	The file definition listed in the scenario is not in the file list.
10.	The scenario contains 0 or over 1000 play files.
11.	There are 0 or over 1000 play files. (Single Media Player (Type 1) only)

- For error code 1 and 11, only the error code and the detail of the error are displayed as shown below.

1

No USB memory is inserted.

Supplementary note

The USB memory contents check does not determine whether or not a play file is playable.

If a file cannot be played while Media Player is active, an error message will be displayed.

Starting / ending Media Player

Start

1. Insert the USB memory device for Media Player into the USB terminal at the bottom of the display unit.

Note

- Depending on the type of a USB memory device, it may come in contact with the periphery such as a back cover, and cannot be attached. Use a commercially sold extension cable, or use a small type of a USB memory device connectable to this unit.

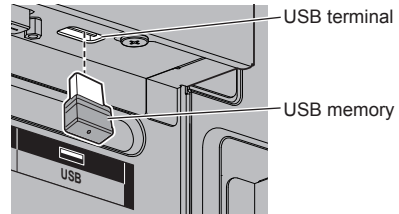

2. Run a USB memory contents check.
3. Change INPUT to [USB].

Ending

Change INPUT to other than [USB].

Resume Play function

After Media Player ends, the file to be played back next time varies depending on the setting of [USB media player settings] - [Resume play].

When set to [On]:

The file played prior to the end of Media Player starts playing from the beginning.

When set to [Off]:

Play starts from the beginning of the first file of the scenario.

Note

- The resume play function is retained until the unit is turned off or the USB memory device is taken out.

Data Cloning

Menu settings and adjusted values set on a single display can be copied to multiple displays using a USB memory.

■ Data that can be copied

Settings and set values of [Picture], [Sound], [Setup], [Position] and [Options] menus

- The following data cannot be copied. Setting is required for each display.

Display ID in [Options] - [Display ID]

Settings and adjusted values of OpenPort PLATFORM

■ Supported device

- Commercially available USB memory devices are supported. (Those with security functions are not supported.)
- USB memory devices other than those formatted in FAT16 or FAT32 cannot be used.
- Up to 32 GB of USB memory in size are supported.
- Only single partition configuration is supported.

Note

- If the sizes of the displays are different, the cloning function does not operate. Use the common sized displays.
- The remote control is used to display [USB data cloning] menu. Main unit buttons cannot be used to display the menu.
- Set the input to something other than [USB], and perform the data cloning.

Copying the display data to the USB memory

1 Insert the USB memory device to the USB terminal on the bottom of the display of data copy source.

After the [Select Copy Type] screen is displayed, go to the step 5.

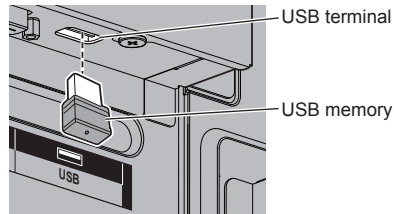

Note

- If the USB memory containing the data for cloning is connected in power-on state, the [Select Copy Type] message in step 5 is displayed.
- Depending on the type of a USB memory device, it may come in contact with the periphery such as a back cover, and cannot be attached. Use a commercially sold extension cable, or use a small type of a USB memory device connectable to this unit.
- Failure to save in or read from the USB memory displays an error message.

2 Display [Setup] menu pressing <SETUP>.

3 Select [OSD language] with ▲ ▼ and press <ENTER> for over 3 seconds.

The following display appears.

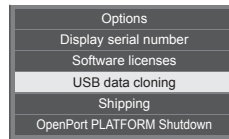

4 Select [USB data cloning] with ▲ ▼ and press <ENTER>.

5 Select [Display → USB Memory] with ▲ ▼ and press <ENTER>.



6 Select [YES] with ◀▶ and press <ENTER>.

Data copy to the USB memory starts.

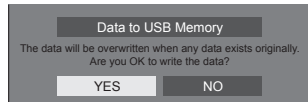

The following message is displayed after data copy has finished.

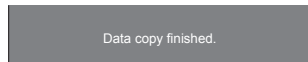

7 After data copy has finished, remove the USB memory device from the USB terminal.

Copying the USB memory data to the display

1 Insert the USB memory device with copied data to the USB terminal on the bottom of the display of data copy destination (same as the step 1 on page 107).

After the [Select Copy Type] screen is displayed, go to the step 5.

Note

- If the USB memory containing the data for cloning is connected in power-on state, the [Select Copy Type] message in step 5 is displayed.

2 Display [Setup] menu pressing <SETUP>.

3 Select [OSD language] with ▲▼ and press <ENTER> for over 3 seconds.

The following display appears.

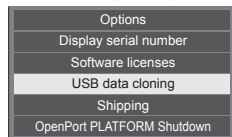

4 Select [USB data cloning] with ▲▼ and press <ENTER>.

5 Select [USB Memory → Display] with ▲▼ and press <ENTER>.



6 Select [YES] with ◀▶ and press <ENTER>.

Data copy to the display starts.

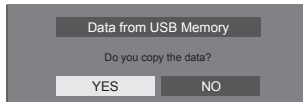

The following message is displayed after data copy has finished.

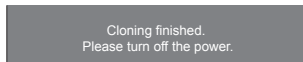

7 After data copy has finished, remove the USB memory device from the USB terminal.

8 Press the <Main Power On / Off button> to turn the power OFF, and turn the power ON again.

The copied content is applied to the display.

- If the <Main Power On / Off button> is locked, please disconnect the AC cord plug from the wall outlet.
- When USB memory is not removed in the step 7, the message [Select Copy Type] is displayed when the display is turned on again.

Note

- If the data is copied with [POWER button lock] set to [On], this function operates after turning the power off, and the <Main Power On / Off button> cannot be used to turn the power on. In this case, remove the power plug, wait sufficient time, and then connect the power plug again to turn the power on.
- [POWER button lock] function is only for TH- 55AF1U, TH-49AF1U and TH-42AF1U.

ID Remote Control Function

You can set the remote control ID when you want to use this remote control on one of several different displays. In that case, you need to set the remote control's ID number to match the Display's ID number you have set in [Display ID] following the steps below.

Note

- To operate this function, please purchase ID remote controller sold separately.
Object model: N2QAYA000093



- When operating the OpenPort PLATFORM part on this ID remote control, the <DEFAULT> button, <RETURN> button and number <6> button operate as the <HOME> button, <BACK> button and <KEYBOARD> button respectively.



Setting the remote control's ID number

1 Set [Controller ID function] to [On].

(see page 94)

- While displaying [Options] menu, you can operate even if the ID does not match.

2 Set the remote control's <ID MODE> switch to <ON>.

3 Pointing the remote control at the Display you want to control, press <ID SET>.

ID set	
Display ID	0
Controller ID	?

4 Press one of <0> - <9>.

Sets the tens digit.

5 Press one of <0> - <9>.

Sets the units digit.

- The steps from 3 to 5 need to be done within 5 seconds.
- Adjustable ID number range is 0 - 100.

Example:

- To set the ID to "1": After step 3, press <0> and then <1>.
- To set the ID to "12": After step 3, press <1> and then <2>.
- To set the ID to "100": After step 3, press <1> <0> <0>.

Cancelling the setting of remote control's ID number (ID "0")

You can operate even if the ID does not match the ID set in [Display ID].

Press <ID SET> for more than 3 seconds.

This has the same effect as pressing <ID SET> <0> <0>.

Note

- The ID remote control cannot be used when [Display ID] is set to anything other than "0", and the remote control ID is not the same as the [Display ID] number. (see page 94)

Preset Signals

This unit can display the video signals shown in the table below.

■ Video signal

Corresponding signal	Resolution (Dot)	Scanning frequency		Dot clock frequency (MHz)	Format**3
		Horizontal (kHz)	Vertical (Hz)		
NTSC/NTSC4.43/ PAL-M/PAL60	720 × 480i	15.7	59.9	-	V
PAL/PAL-N/SECAM	720 × 576i	15.6	50.0	-	V
525i(480i)	720 × 480i	15.7	59.9	13.5	R/Y
625i(576i)	720 × 576i	15.6	50.0	13.5	R/Y
525i(480i)	720(1440) × 480i*2	15.7	59.9	27.0	D/H
625i(576i)	720(1440) × 576i*2	15.6	50.0	27.0	D/H
525p(480p)	720 × 480	31.5	59.9	27.0	R/Y/D/H
625p(576p)	720 × 576	31.3	50.0	27.0	R/Y/D/H
750(720)/60p	1 280 × 720	45.0	60.0	74.3	R/Y/D/H
750(720)/50p	1 280 × 720	37.5	50.0	74.3	R/Y/D/H
1 125(1 080)/60i*1	1 920 × 1 080i	33.8	60.0	74.3	R/Y/D/H
1 125(1 080)/50i	1 920 × 1 080i	28.1	50.0	74.3	R/Y/D/H
1 125(1 080)/24p	1 920 × 1 080	27.0	24.0	74.3	R/Y/D/H
1 125(1 080)/24PsF	1 920 × 1 080i	27.0	48.0	74.3	R/Y
1 125(1 080)/25p	1 920 × 1 080	28.1	25.0	74.3	R/Y/D/H
1 125(1 080)/30p	1 920 × 1 080	33.8	30.0	74.3	R/Y/D/H
1 125(1 080)/60p	1 920 × 1 080	67.5	60.0	148.5	R/Y/D/H
1 125(1 080)/50p	1 920 × 1 080	56.3	50.0	148.5	R/Y/D/H

■ PC signal

Corresponding signal	Resolution (Dot)	Scanning frequency		Dot clock frequency (MHz)	Format**3
		Horizontal (kHz)	Vertical (Hz)		
640 × 400**6	640 × 400	31.5	70.1	25.2	R/Y/D/H
	640 × 400	37.9	85.1	31.5	R/Y/D/H
640 × 480**6	640 × 480	31.5	59.9	25.2	R/Y/D/H
	640 × 480	35.0	66.7	30.2	R/Y/D/H
	640 × 480	37.9	72.8	31.5	R/Y/D/H
	640 × 480	37.5	75.0	31.5	R/Y/D/H
	640 × 480	43.3	85.0	36.0	R/Y/D/H
800 × 600**6	800 × 600	35.2	56.3	36.0	R/Y/D/H
	800 × 600	37.9	60.3	40.0	R/Y/D/H
	800 × 600	48.1	72.2	50.0	R/Y/D/H
	800 × 600	46.9	75.0	49.5	R/Y/D/H
	800 × 600	53.7	85.1	56.3	R/Y/D/H
832 × 624**6	832 × 624	49.7	74.6	57.3	R/Y/D/H
852 × 480	852 × 480	31.5	59.9	34.2	D/H
1 024 × 768**6	1 024 × 768	39.6	50.0	51.9	D/H
	1 024 × 768	48.4	60.0	65.0	R/Y/D/H
	1 024 × 768	56.5	70.1	75.0	R/Y/D/H
	1 024 × 768	60.0	75.0	78.8	R/Y/D/H
	1 024 × 768	65.5	81.6	86.0	R/Y/D/H
	1 024 × 768	68.7	85.0	94.5	R/Y/D/H
1 066 × 600	1 066 × 600	37.6	59.9	53.0	D/H
1 152 × 864**6	1 152 × 864	53.7	60.0	81.6	R/Y/D/H
	1 152 × 864	64.0	70.0	94.2	R/Y/D/H
	1 152 × 864	67.5	74.9	108.0	R/Y/D/H
	1 152 × 864	77.1	85.0	119.7	R/Y/D/H
1 152 × 870**6	1 152 × 870	68.7	75.1	100.0	R/Y/D/H
1 280 × 720**6	1 280 × 720	44.8	59.9	74.5	R/Y/D/H

Corresponding signal	Resolution (Dot)	Scanning frequency		Dot clock frequency (MHz)	Format**3
		Horizontal (kHz)	Vertical (Hz)		
1 280 × 768*6	1 280 × 768	39.6	49.9	65.3	R/Y/D/H
	1 280 × 768	47.7	60.0	80.1	R/Y/D/H
	1 280 × 768	47.8	59.9	79.5	R/Y/D/H
1 280 × 800*6	1 280 × 800	41.3	50.0	68.0	R/Y/D/H
	1 280 × 800	49.3	59.9	71.0	R/Y/D/H
	1 280 × 800	49.7	59.8	83.5	R/Y/D/H
1 280 × 960*6	1 280 × 960	60.0	60.0	108.0	R/Y/D/H
	1 280 × 960	85.9	85.0	148.5	R/Y
1 280 × 1 024*6	1 280 × 1 024	64.0	60.0	108.0	R/Y/D/H
	1 280 × 1 024	80.0	75.0	135.0	R/Y/D/H
	1 280 × 1 024	91.1	85.0	157.5	R/Y/D/H
1 360 × 768	1 360 × 768	47.7	60.0	85.5	D/H
	1 360 × 768	47.7	60.0	84.7	D/H
	1 360 × 768	47.7	59.8	84.8	D/H
1 366 × 768*6	1 366 × 768	39.6	50.0	69.9	D/H
	1 366 × 768	48.4	60.0	86.7	R/Y/D/H
	1 366 × 768	48.0	60.0	72.0	R/Y/D/H
	1 366 × 768	39.6	49.9	69.0	R/Y/D/H
	1 366 × 768	47.7	59.8	85.5	R/Y/D/H
1 400 × 1 050*6	1 400 × 1 050	65.2	60.0	122.6	D/H
	1 400 × 1 050	82.2	75.0	155.9	R/Y/D/H
1 440 × 900*6	1 440 × 900	55.5	59.9	88.8	R/Y/D/H
	1 440 × 900	55.9	59.9	106.5	R/Y/D/H
1 600 × 900*6	1 600 × 900	46.3	50.0	97.0	D/H
	1 600 × 900	60.0	60.0	108.0	D/H
	1 600 × 900	55.9	60.0	118.3	D/H
	1 600 × 900	56.0	60.0	119.0	D/H
1 680 × 1 050*6	1 680 × 1 050	65.3	60.0	146.3	R/Y/D/H
1 600 × 1 200*6	1 600 × 1 200*4	75.0	60.0	162.0	R/Y/D/H
1 920 × 1 080*6	1 920 × 1 080*5	66.6	59.9	138.5	R/Y/D/H
	1 920 × 1 080	67.5	60.0	148.5	R/Y/D/H
1 920 × 1 200*6	1 920 × 1 200*4	74.0	60.0	154.0	R/Y/D/H

*1: When 1 125(1 035)/60i signal is input, it is displayed as 1 125(1 080)/60i signal.

*2: Pixel-Repetition signal (dot clock frequency 27.0 MHz) only

*3: Signals to represent formats are as follows.

V: Composite Video (VIDEO IN)

R: D-sub RGB (RGB IN, PC IN)

Y: YCbCr/YPbPr (COMPONENT IN, PC IN)

D: DVI-D (DVI-D IN)

H: HDMI (HDMI 1, HDMI 2)

The analogue input supports onG and onY.

*4: Displayed with image elements thinned out in the image processing circuit.

*5: Based on VESA CVT-RB (Reduced Blanking) standard

*6: The picture may not be displayed correctly with the PC signal from COMPONENT IN/RGB IN inputs.

Note

- An auto detected signal format may be differently displayed from the actual input signal.
- [i] shown after the number of dots of resolution means the interlace signal.
- When 1 125(1 080)/30PsF signal and 1 125(1 080)/25PsF signal are input, they are processed as 1 125(1 080)/60i signal and 1 125(1 080)/50i signal, and then displayed.

OpenPort PLATFORM Shutdown

It is possible to force OpenPort PLATFORM system to shutdown in the following way.

- 1 Press <SETUP> to display the [Setup] menu.
- 2 Select [OSD language] with ▲▼ and press <ENTER> for more than 3 seconds.

The following screen will be displayed.

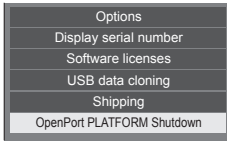

- 3 Select [OpenPort PLATFORM Shutdown] with ▲▼ and press <ENTER>.

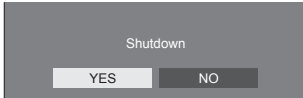

- 4 Select [YES] with ◀▶ and press <ENTER>.

When it is being shutdown, the power indicator turns green to orange and the message [Shutting down OpenPort PLATFORM. Please wait.] is displayed. After that, shifts to standby condition (Power Indicator: Red).

Note

- Remote control operation and external control command are not valid while OpenPort PLATFORM system.
- When the power is turned on after OpenPort PLATFORM system is shutdown and in standby condition (Power Indicator: Red), only <Standby (ON/OFF) button> and "PON" command from SERIAL terminal are valid.
- The display may be greyed out in some conditions, such as when the OpenPort PLATFORM system is starting up. In this case, the OpenPort PLATFORM cannot be shut down.

Shipping condition

You can reset the settings / the adjusted values of the following menus to the factory settings:

[Picture], [Sound], [Setup], [Position], [Options]

At the same time, resets the settings and the data of OpenPort PLATFORM to the factory settings and also deletes the applications you have installed.

■ Remote control

- 1 Press **<SETUP>** to display the **[Setup]** menu.
- 2 Select **[OSD language]** with **▲▼** and press **<ENTER>** for more than 3 seconds.

The following screen will be displayed.

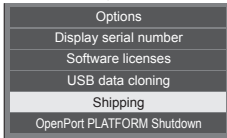

- 3 Select **[Shipping]** with **▲▼** and press **<ENTER>**.

Note

- The display may be greyed out in some conditions, such as when the OpenPort PLATFORM system is starting up. In this case, the **<ENTER>** operation is disabled.

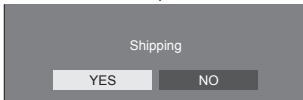

- 4 Select **[YES]** with **◀▶** and press **<ENTER>**.

The message [Shipping (Wait a moment)] will be displayed.

- 5 After the message **[Please turn off the power]** is displayed, turn the power off pressing **<Main Power On / Off button>**.

- If the **<Main Power On / Off button>** is locked, please disconnect the AC cord plug from the wall outlet.

■ Unit

- 1 Press **<MENU (Unit)>** for several times and display the **[Setup]** menu.
- 2 Select **[OSD language]** with **▲▼**, and then press and hold **<ENTER (Unit)>** for more than 5 seconds.

Note

- The display may be greyed out in some conditions, such as when the OpenPort PLATFORM system is starting up. In this case, the **<ENTER (Unit)>** operation is disabled.

- 3 Select **[YES]** with **<- (Unit)>** or **<+ (Unit)>** and press **<ENTER (Unit)>**.











The message [Shipping (Wait a moment)] will be displayed.

- 4 After the message **[Please turn off the power]** is displayed, turn the power off pressing **<Main Power On / Off button>**.

- If the **<Main Power On / Off button>** is locked, please disconnect the AC cord plug from the wall outlet.

Troubleshooting

Before you call for service, determine the symptoms and make a few simple checks as shown below.

Symptoms		Check
Picture	Sound	
 <p>Interference</p>	 <p>Noisy Sound</p>	Electrical Appliances Cars / Motorcycles Fluorescent light
 <p>Normal Picture</p>	 <p>No Sound</p>	Volume (Check whether the mute function has been activated on the remote control.)
 <p>No Picture</p>	 <p>No Sound</p>	Not plugged into AC outlet Not switched on Picture and Brightness/Volume setting (Check by pressing the <Main Power On / Off button> or the <Standby (ON/OFF) button>.)
 <p>No Picture</p>	 <p>Normal Sound</p>	If a signal with a non-applicable colour system format, or frequency is input, only the input terminal indication is displayed.
 <p>No Colour</p>	 <p>Normal Sound</p>	Colour controls set at minimum level (see page 71, 73)
A display error such as "no picture" occurs, or remote control operation is suddenly disabled.		This unit incorporates highly-advanced software. If you notice an abnormal operation such as "Remote control cannot be operated" or "Display is disturbed", remove the power plug from the socket outlet, and inset it again after 5 seconds or more to turn the power on. (see page 35)
Power automatically turns off unexpectedly.		Check the settings of [No signal power off], [HDMI1 power management], [HDMI2 power management], [DVI-D power management], [PC power management] and [No activity power off]. Any of them may be set to [On (Enable)]. (see page 81)
Power indicator is blinking in red.		There is possibility of malfunction. Please contact an Authorized Service Centre.

Symptoms	Check
No remote control operations can be performed.	<p>Check whether the batteries have discharged completely and, if they have not, whether they were inserted properly.</p> <p>Check whether the remote control sensor is exposed to an outdoor light or a strong fluorescent light.</p> <p>Check whether any obstacle is present between the remote control sensor and the remote control.</p> <p>If the installation condition is normal, pull out the remote control sensor from the edge side of the main unit when using.</p> <p>Check whether the remote control designed specifically for use with the unit is being used. (The unit cannot be operated by any other remote control.)</p> <p>Check whether the option other than [Off] is selected in [Controller user level] in the [Options] menu. (see page 93)</p> <p>Check whether [Controller ID function] in [Options] menu is set to [On]. (see page 94)</p> <p>Check whether <ID MODE> switch is set to <ON>. (When using ID remote controller) (see page 109)</p> <p>For operation of the OpenPort PLATFORM part, the remote control operation may be impossible with the Android standard application or additionally installed application.</p> <p>In this case, use a USB mouse for operation. (see page 43)</p>
[Controller ID function] function cannot be used. (When using ID remote controller)	<p>Check whether [Controller ID function] is set to [On], or <ID MODE> switch is set to <ON>. (see page 94)</p> <p>(When [Controller ID function] is set to [On], you need to set <ID MODE> switch to <ON> and set the ID number.)</p>
The top or bottom of the picture on the screen is cut off.	<p>The image position has been adjusted in the [Position] menu.</p> <p>Adjust the position of the picture on the screen. (see page 68, 69)</p>
There are areas at the top and bottom of the screen where picture is not displayed.	<p>When using a video software program (such as a cinema size program) with a screen wider than one in the 16:9 mode, blank areas separate from the images are formed at the top and bottom of the screen.</p>
Parts of the unit become hot.	<p>Even when the temperature of parts of the front, top and rear panels has risen, these temperature rises will not pose any problems in terms of performance or quality.</p>
There is no picture displayed or sound output sometimes.	<p>When HDMI or DVI signals are input to the Display using a selector or distributor, sound or images may not be output in the normal fashion depending on the selector or distributor used.</p> <p>The symptoms may be improved by turning the power off and on again, or by replacing the selector or distributor.</p>
The RS-232C is uncontrollable.	<p>Check whether the connection has been made properly. (see page 25)</p>
The LAN is uncontrollable.	<p>Check that the connection has been made properly. (see page 97)</p> <p>To control with command control, check that [LAN Control] in OpenPort PLATFORM is set properly. Check that [Command Control] is set to [ON]. (see page 54)</p> <p>Check that [WIRELESS & NETWORKS] in OpenPort PLATFORM is set properly. (see page 55)</p> <p>Perform the LAN control after startup of OpenPort PLATFORM. (see page 40, 83)</p>

Symptoms	Check
Applications cannot be downloaded with OpenPort PLATFORM.	<p>Check that the connection has been made properly. (see page 97)</p> <p>Check that [WIRELESS & NETWORKS] in OpenPort PLATFORM is set properly. (see page 55)</p> <p>You can check the network-related setting information or [Check Communication] in [STATUS] of OpenPort PLATFORM. (see page 52)</p>
The application installed with OpenPort PLATFORM does not operate, or the operation is unstable.	<p>Check that the home screen of OpenPort PLATFORM is displayed with <HOME> button of the remote control, etc. If the home screen is displayed properly, the application may not be operating properly.</p> <p>Check the usage on the operation manual of the application. If the operation does not improve, consult the technical support of the application.</p>

LCD Display panel

Symptoms	Check
The screen darkens slightly when bright pictures with minimal movements are shown.	The screen will darken slightly when photos, still images of a computer or other pictures with minimal movements are shown for an extended period. This is done to reduce image retention on the screen and the shortening of the screen's service life: It is normal and not indicative of malfunctioning.
It takes a while for the picture to appear.	The unit digitally processes the various signals in order to reproduce esthetically pleasing images. As such, it sometimes takes a few moments for the picture to appear when the power has been turned on, when the input has been switched.
The edges of the images flicker.	Due to the characteristics of the system used to drive the panel, the edges may appear to flicker in the fast-moving parts of the images: This is normal and not indicative of malfunctioning.
There may be red spots, blue spots, green spots and black spots on the screen.	This is a characteristic of liquid crystal panels and is not a problem. The liquid crystal panel is built with very high precision technology giving you fine picture details. Occasionally, a few non-active pixels may appear on the screen as fixed points of red, blue, green, or black. Please note this does not affect the performance of your LCD.
 <p>Image retention appears</p>	Image retention may occur. If you display a still picture for an extended period, the image might remain on the screen. However, it will disappear when a general moving picture is displayed for a while. This is not considered as malfunction.

This LCD Display uses special image processing. Hence a slight time lag may occur between image and audio, depending on the type of input signal. However, this is not a malfunction.

Specifications

Model No.

55-inch model : TH-55AF1U

49-inch model : TH-49AF1U

42-inch model : TH-42AF1U

55-inch model : TH-55AF1W

49-inch model : TH-49AF1W

42-inch model : TH-42AF1W

Power Consumption

55-inch model

190 W

49-inch model

175 W

42-inch model

155 W

Power off condition

0.3 W

Stand-by condition

- When [OpenPort PLATFORM standby] is set to [Off] (Factory default (TH-55AF1U, TH-49AF1U, TH-42AF1U))

0.5 W

Stand-by condition

- When [OpenPort PLATFORM standby] is set to [On] (Factory default (TH-55AF1W, TH-49AF1W, TH-42AF1W))

Approx. 20 W

LCD Display panel

55-inch model

55-inch IPS panel (Edge LED backlight), 16:9 aspect ratio

49-inch model

49-inch IPS panel (Edge LED backlight), 16:9 aspect ratio

42-inch model

42-inch IPS panel (Edge LED backlight), 16:9 aspect ratio

Screen size

55-inch model

1 209 mm (W) × 680 mm (H) × 1 387 mm (diagonal) / 47.6" (W) × 26.7" (H) × 54.6" (diagonal)

49-inch model

1 073 mm (W) × 604 mm (H) × 1 232 mm (diagonal) / 42.2" (W) × 23.7" (H) × 48.5" (diagonal)

42-inch model

927 mm (W) × 521 mm (H) × 1 064 mm (diagonal) /

36.5" (W) × 20.5" (H) × 41.9" (diagonal)

Number of pixels

2 073 600 (1 920 (W) × 1 080 (H))

Dimensions (W × H × D)

55-inch model

1 229 mm × 699 mm × 72 mm (57 mm: without handles) /

48.4" × 27.6" × 2.8" (2.3": without handles)

49-inch model

1 093 mm × 623 mm × 72 mm (57 mm: without handles) /

43.1" × 24.6" × 2.8" (2.3": without handles)

42-inch model

947 mm × 541 mm × 72 mm (57 mm: without handles) /

37.3" × 21.3" × 2.8" (2.3": without handles)

Mass

55-inch model

Approx. 25.0 kg / 55.2 lbs net

49-inch model

Approx. 19.3 kg / 42.6 lbs net

42-inch model

Approx. 15.6 kg / 34.4 lbs net

Power source

TH-55AF1U, TH-49AF1U, TH-42AF1U:

110 - 127V ~ (110 - 127V alternating current), 50/60Hz

TH-55AF1W, TH-49AF1W, TH-42AF1W:

220 - 240V ~ (220 - 240V alternating current), 50/60Hz

Operating condition

Temperature

0 °C to 40 °C (32 °F to 104 °F)*1

Humidity

20 % to 80 % (no condensation)

Storing condition

Temperature

-20 °C to 60 °C (-4 °F to 140 °F)

Humidity

20 % to 80 % (no condensation)

OpenPort PLATFORM system

OS

Android 4.4.3

CPU

Cortex-A9, 1.0 GHz (quad)

Memory

RAM 1 GB / ROM 8 GB

Supported codec

Video: MPEG4, H.264/AVC, H.263, MotionJPEG, MPEG2, WMV, VP8

Audio: MP3, AAC, WMA, AMR, Ogg Vorbis

OpenPort PLATFORM part

USB (OpenPort PLATFORM)

USB connector × 3, TYPE A
USB2.0

Micro-USB

Micro-USB connector, Micro-B
USB2.0

microSD card slot

microSD, microSDHC

LAN

For RJ45 network connections, compatible with PLink

Communication method:

RJ45 10BASE-T/100BASE-TX/1000BASE-T

Wireless LAN module

IEEE 802.11a/b/g/n

Connection terminals

HDMI 1

HDMI 2

TYPE A Connector*2 × 2

Audio signal:

Linear PCM (sampling frequencies - 48 kHz, 44.1 kHz, 32 kHz)

DVI-D IN

DVI-D 24 Pin:

Compliance with DVI Revision 1.0

Content Protection:

Compatible with HDCP 1.1

DVI-D OUT

DVI-D 24 Pin:

Compliance with DVI Revision 1.0

Content Protection:

Compatible with HDCP 1.1

COMPONENT/RGB IN

Y/G

BNC terminal 1.0 Vp-p (75 Ω) (with sync signal)

P_B/C_B/B

BNC terminal 0.7 Vp-p (75 Ω) (without sync signal)

P_R/C_R/R

BNC terminal 0.7 Vp-p (75 Ω) (without sync signal)

VIDEO IN

VIDEO

BNC terminal 1.0 Vp-p (75 Ω)

Also used as Y/G terminal

PC IN

Mini D-sub 15 Pin (Compatible with DDC2B)

Y/G:

1.0 Vp-p (75 Ω) (with sync signal)

0.7 Vp-p (75 Ω) (without sync signal)

P_B/C_B/B:

0.7 Vp-p (75 Ω) (without sync signal)

P_R/C_R/R:

0.7 Vp-p (75 Ω) (without sync signal)

HD/VD:

1.0 - 5.0 Vp-p (high impedance)

AUDIO1 IN

Stereo mini jack (M3) 0.5 Vrms

Shared with DVI-D IN and PC IN

AUDIO2 IN

Stereo mini jack (M3) 0.5 Vrms

Shared with COMPONENT/RGB IN and VIDEO IN

AUDIO OUT

Stereo mini jack (M3) 0.5 Vrms

Output: Variable (-∞ to 0 dB)

(1 kHz 0 dB input, 10 kΩ load)

USB

USB connector, TYPE A

DC 5V / 1A (USB 3.0 is not supported.)

Control terminals

SERIAL IN

External Control Terminal
D-sub 9 Pin:
RS-232C compatible

SERIAL OUT

External Control Terminal
D-sub 9 Pin:
RS-232C compatible

IR IN

Stereo mini jack (M3)

IR OUT

Stereo mini jack (M3)

Sound

Built-in speakers

80 mm × 30 mm × 2 pieces

Audio Output

20 W [10 W + 10 W] (10 % THD)

Remote Control Transmitter

Power source

DC 3 V (battery (AAA/R03/UM4 type) × 2)

Operating range

Approx. 7 m (22.9 ft)
(when operated directly in front of remote control sensor)

Mass

Approx. 63 g / 2.22 oz (including batteries)

Dimensions (W × H × D)

44 mm × 105 mm × 20.5 mm /
1.74" × 4.14" × 0.81"

*1: Environmental temperature to use this unit at high altitudes (1 400 m (4 593 ft) and higher and below 2 800 m (9 186 ft) above sea level): 0 °C to 35 °C (32 °F to 95 °F)

*2: VIERA LINK is not supported.

Note

- Design and specifications are subject to change without notice. Mass and dimensions shown are approximate.

Software License

This product incorporates the following software:

- (1) the software developed independently by or for Panasonic Corporation,
- (2) the software owned by third party and licensed to Panasonic Corporation,
- (3) the software licensed under the GNU General Public License, Version 2.0 (GPL V2.0),
- (4) the software licensed under the GNU LESSER General Public License, Version 2.1 (LGPL V2.1), and/or
- (5) open source software other than the software licensed under the GPL V2.0 and/or LGPL V2.1.

The software categorized as (3) - (5) are distributed in the hope that it will be useful, but WITHOUT ANY WARRANTY, without even the implied warranty of MERCHANTABILITY or FITNESS FOR A PARTICULAR PURPOSE. For details, see the license conditions displayed by selecting [Software licenses], following the specified operation from the initial setting menu of this product and the license conditions displayed by selecting [Legal information], following the specified operation from the [Settings] application of this product.

At least three (3) years from delivery of this product, Panasonic will give to any third party who contacts us at the contact information provided below, for a charge no more than our cost of physically performing source code distribution, a complete machine-readable copy of the corresponding source code covered under GPL V2.0, LGPL V2.1 or the other licenses with the obligation to do so, as well as the respective copyright notice thereof.

Contact Information:

oss-cd-request@gg.jp.panasonic.com

Notice about AVC/VC-1/MPEG-4

This product is licensed under the AVC Patent Portfolio License, VC-1 Patent Portfolio License and MPEG-4 Visual Patent Portfolio License for the personal use of a consumer or other uses in which it does not receive remuneration to (i) encode video in compliance with the AVC Standard, VC-1 Standard and MPEG-4 Visual Standard ("AVC/VC-1/MPEG-4 Video") and/or (ii) decode AVC/VC-1/MPEG-4 Video that was encoded by a consumer engaged in a personal activity and/or was obtained from a video provider licensed to provide AVC/VC-1/MPEG-4 Video. No license is granted or shall be implied for any other use. Additional information may be obtained from MPEG LA, LLC. See <http://www.mpegla.com>.

Information for Users on Collection and Disposal of Old Equipment and used Batteries



These symbols on the products, packaging, and/or accompanying documents mean that used electrical and electronic products and batteries should not be mixed with general household waste. For proper treatment, recovery and recycling of old products and used batteries, please take them to applicable collection points, in accordance with your national legislation and the Directives 2002/96/EC and 2006/66/EC.



By disposing of these products and batteries correctly, you will help to save valuable resources and prevent any potential negative effects on human health and the environment which could otherwise arise from inappropriate waste handling.



For more information about collection and recycling of old products and batteries, please contact your local municipality, your waste disposal service or the point of sale where you purchased the items.

Penalties may be applicable for incorrect disposal of this waste, in accordance with national legislation.

For business users in the European Union

If you wish to discard electrical and electronic equipment, please contact your dealer or supplier for further information.

[Information on Disposal in other Countries outside the European Union]



These symbols are only valid in the European Union. If you wish to discard these items, please contact your local authorities or dealer and ask for the correct method of disposal.

Notice for the battery symbol (bottom two symbol examples):



This symbol might be used in combination with a chemical symbol. In this case it complies with the requirement set by the Directive for the chemical involved.

Notice (U.S.A. only)

Disposal may be regulated in your community due to environmental considerations. For disposal or recycling information, please visit Panasonic website:

<http://www.panasonic.com/environmental>

or call 1-888-769-0149.

Customer's Record

The model number and serial number of this product may be found on its rear panel. You should note this serial number in the space provided below and retain this book, plus your purchase receipt, as a permanent record of your purchase to aid in identification in the event of theft or loss, and for Warranty Service purposes.

Model Number

Serial Number

For TH-55AF1U, TH-49AF1U and TH-42AF1U

Panasonic System Communications Company of North America

Unit of Panasonic Corporation of North America

Executive Office :

Two Riverfront Plaza, Newark, New Jersey 07102-5490

Panasonic Canada Inc.

5770 Ambler Drive

Mississauga, Ontario

L4W 2T3

For TH-55AF1W, TH-49AF1W and TH-42AF1W

Panasonic Testing Centre

Panasonic Service Europe, a division of Panasonic Marketing Europe GmbH

Winsbergring 11, 22525 Hamburg, F.R. Germany

Panasonic Corporation

Web Site: <http://panasonic.com>

English

TP0216TS0 -PB