

SAMSUNG

USER MANUAL

5 SERIES

Thank you for purchasing this Samsung product.



To receive more complete service, please register your product at www.samsung.com/register

Model _____ Serial No. _____

Before Reading This User Manual

This TV comes with this user manual and an embedded e-Manual.

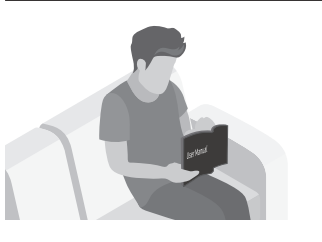
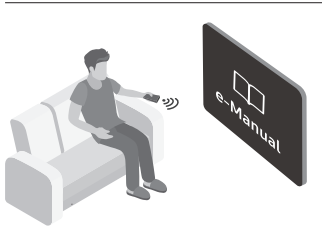
Before reading this user manual, review the following:







| | | |
|-----------------------------------------------------------------------------------|--------------------|---------------------------------------------------------------------------------------------------------------------------------------------------------------------------------------------------------------------------------------------------------------------------------------------------------------------------------------------------------------------------------------------------------|
|  | User Manual | Read this provided user manual to see information about product safety, installation, accessories, initial configuration, and product specifications. |
|  | e-Manual | For more information about this TV, read the e-Manual embedded in the product. <ul style="list-style-type: none">• To open the e-Manual,•  >  Settings > Support > Open e-Manual |

On the website, you can download the user manual and see its contents on your PC or mobile device.

* The figures and illustrations in this User Manual are provided for reference only and may differ from the actual product appearance. The product design and specifications may change without notice. CIS languages (Russian, Ukrainian, Kazakhs) are not available for this product, since this is manufactured for customers in the EU region.

Warning! Important Safety Instructions

Please read the Safety Instructions before using your TV.

| | | | |
|-----------------------------------------------------------------------------------------------------------------------------------------------------------------------|------------------------------------------------------------------------------------------------------------------------------------------------|------------------------------------------------------------------------------------|------------------------------------------------------------------------------------------------------------------------------------------|
| CAUTION | |  | Class II product: This symbol indicates that a safety connection to electrical earth (ground) is not required. |
| RISK OF ELECTRIC SHOCK. DO NOT OPEN. | | | |
| CAUTION: TO REDUCE THE RISK OF ELECTRIC SHOCK, DO NOT REMOVE COVER (OR BACK). THERE ARE NO USER SERVICEABLE PARTS INSIDE. REFER ALL SERVICING TO QUALIFIED PERSONNEL. | |  | AC voltage: Rated voltage marked with this symbol is AC voltage. |
|  | This symbol indicates that high voltage is present inside. It is dangerous to make any kind of contact with any internal part of this product. |  | DC voltage: Rated voltage marked with this symbol is DC voltage. |
|  | This symbol indicates that this product has included important literature concerning operation and maintenance. |  | Caution. Consult instructions for use: This symbol instructs the user to consult the user manual for further safety related information. |

- The slots and openings in the cabinet and in the back or bottom are provided for necessary ventilation. To ensure reliable operation of this apparatus and to protect it from overheating, these slots and openings must never be blocked or covered.
 - Do not place this apparatus in a confined space, such as a bookcase or built-in cabinet, unless proper ventilation is provided.
 - Do not place this apparatus near or over a radiator or heat register, or where it is exposed to direct sunlight.
 - Do not place vessels (vases etc.) containing water on this apparatus, as this can result in a fire or electric shock.
- Do not expose this apparatus to rain or place it near water (near a bathtub, washbowl, kitchen sink, or laundry tub, in a wet basement, or near a swimming pool, etc.). If this apparatus accidentally gets wet, unplug it and contact an authorised dealer immediately.
- This apparatus uses batteries. In your community, there might be environmental regulations that require you to dispose of these batteries properly. Please contact your local authorities for disposal or recycling information.
- Do not overload wall outlets, extension cords, or adaptors beyond their capacity, since this can result in fire or electric shock.

- Power-supply cords should be placed so that they are not likely to be walked on or pinched by items placed upon or against them. Pay particular attention to cords at the plug end, at wall outlets, and at the point where they exit from the appliance.
- To protect this apparatus from a lightning storm, or when left unattended and unused for long periods of time, unplug it from the wall outlet and disconnect the antenna or cable system. This will prevent damage to the set due to lightning and power line surges.
- Before connecting the AC power cord to the DC adaptor outlet, make sure that the voltage designation of the DC adaptor corresponds to the local electrical supply.
- Never insert anything metallic into the open parts of this apparatus. This may cause a danger of electric shock.
- To avoid electric shock, never touch the inside of this apparatus. Only a qualified technician should open this apparatus.
- Be sure to plug in the power cord until it is firmly seated. When unplugging the power cord from a wall outlet, always pull on the power cord's plug. Never unplug it by pulling on the power cord. Do not touch the power cord with wet hands.
- If this apparatus does not operate normally - in particular, if there are any unusual sounds or smells coming from it - unplug it immediately and contact an authorised dealer or service centre.
- Be sure to pull the power plug out of the outlet if the TV is to remain unused or if you are to leave the house for an extended period of time (especially when children, elderly, or disabled people will be left alone in the house).
 - Accumulated dust can cause an electric shock, an electric leakage, or a fire by causing the power cord to generate sparks and heat or by causing the insulation to deteriorate.
- Be sure to contact an authorised Samsung service centre for information if you intend to install your TV in a location with heavy dust, high or low temperatures, high humidity, chemical substances, or where it will operate 24 hours a day such as in an airport, a train station, etc. Failure to do so may lead to serious damage to your TV.
- Use only a properly grounded plug and wall outlet.
- An improper ground may cause electric shock or equipment damage. (Class I Equipment only.)
- To turn off this apparatus completely, disconnect it from the wall outlet. To ensure you can unplug this apparatus quickly if necessary, make sure that the wall outlet and power plug are readily accessible.
- Store the accessories (batteries, etc.) in a location safely out of the reach of children.
- Do not drop or strike the product. If the product is damaged, disconnect the power cord and contact a Samsung service centre.
- To clean this apparatus, unplug the power cord from the wall outlet and wipe the product with a soft, dry cloth. Do not use any chemicals such as wax, benzene, alcohol, thinners, insecticide, aerial fresheners, lubricants, or detergents. These chemicals can damage the appearance of the TV or erase the printing on the product.
- Do not expose this apparatus to dripping or splashing.
- Do not dispose of batteries in a fire.
- Do not short-circuit, disassemble, or overheat the batteries.
- There is danger of an explosion if you replace the batteries used in the remote with the wrong type of battery. Replace only with the same or equivalent type.

Contents

| | |
|----------------------------------------------------------------------|----|
| Before Reading This User Manual | 2 |
| Warning! Important Safety Instructions | 3 |
| 01 What's in the Box? | |
| 02 Assembling the TV | |
| Attaching the TV to the Stand | 8 |
| Mounting the TV on a Wall (Optional) | 8 |
| VESA wall mount kit notes and specifications | 9 |
| Providing proper ventilation for your TV | 10 |
| Safety Precaution: Securing the TV to the wall | 10 |
| Preventing the TV from falling | 11 |
| Anti-theft Kensington Lock | 12 |
| 03 Connections | |
| Connecting devices to your TV | 13 |
| Connecting to a COMMON INTERFACE slot (Your TV viewing Card Slot) | 14 |
| 04 Network Connection | |
| Wireless Network Precautions | 15 |
| Network Security Protocols | 16 |
| 05 The TV Controller | |
| Using the TV Controller | 17 |
| The Remote Control | 18 |
| Installing batteries into the remote control (Battery size: AAA) | 19 |
| Teletext Feature | 20 |

| | | |
|-----------|-------------------------------------------------------------------------------|----|
| 06 | Performing the initial setup | |
| | Initial setup | 22 |
| 07 | Selecting Connected Devices | |
| | TOOLS Button | 23 |
| 08 | Getting more details. | |
| | How to use the e-Manual | 24 |
| | Screen Display | 24 |
| | How to toggle between an e-Manual topic and the corresponding OSD menu(s). | 25 |
| 09 | Troubleshooting and Maintenance | |
| | Troubleshooting | 26 |
| | Caring for the TV | 31 |
| | Still image warning | 31 |
| 10 | Specifications and other information | |
| | TV Specifications | 32 |
| | Environmental Considerations | 32 |
| | Licences | 36 |
| | Warranty Card | 39 |
| | WARRANTY CONDITIONS | 39 |

01 What's in the Box?

Please make sure the following items are included with your TV. If any items are missing, contact your dealer.



Remote Control & Batteries (AAA x 2)

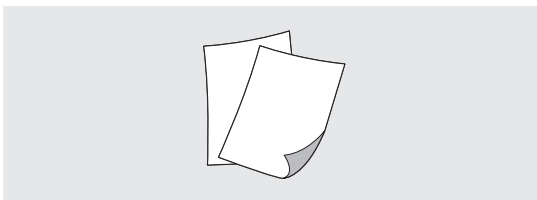

Regulatory Guide /
Warranty Card

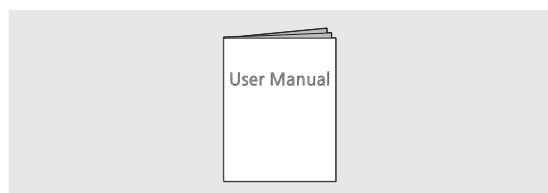

User Manual

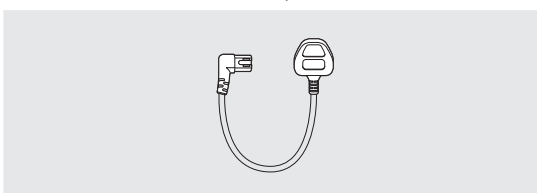

Power Cord
(Depending on the country and model)

- The items' colours and shapes may vary depending on the models.
- Cables not included can be purchased separately.
- Check for any accessories hidden behind or in the packing materials when opening the box.

An administration fee may be charged if either

(a) an engineer is called out at your request and there is no defect with the product (i.e. where the user manual has not been read).

(b) you bring the unit to a repair centre and there is no defect with the product (i.e. where the user manual has not been read).

You will be informed of the administration fee amount before a technician visits.



Warning: Screens can be damaged from direct pressure when handled incorrectly. We recommend lifting the TV at the edges, as shown.

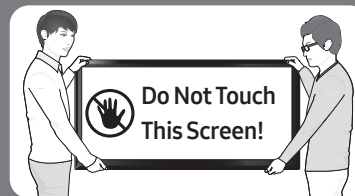

02 Assembling the TV

Attaching the TV to the Stand

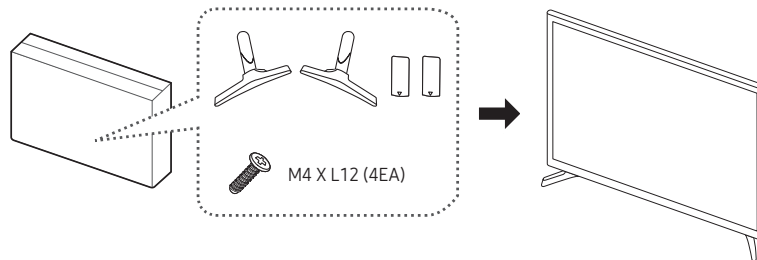

Make sure you have all the accessories shown, and that you assemble the stand following the provided assembly instructions.

Mounting the TV on a Wall (Optional)



If you mount this product on a wall, follow the instructions exactly as recommended by the manufacturer. Unless it is correctly mounted, the product may slide or fall, thus causing serious injury to a child or adult and serious damage to the product.

You can mount the TV on the wall using a wall mount kit (sold separately).

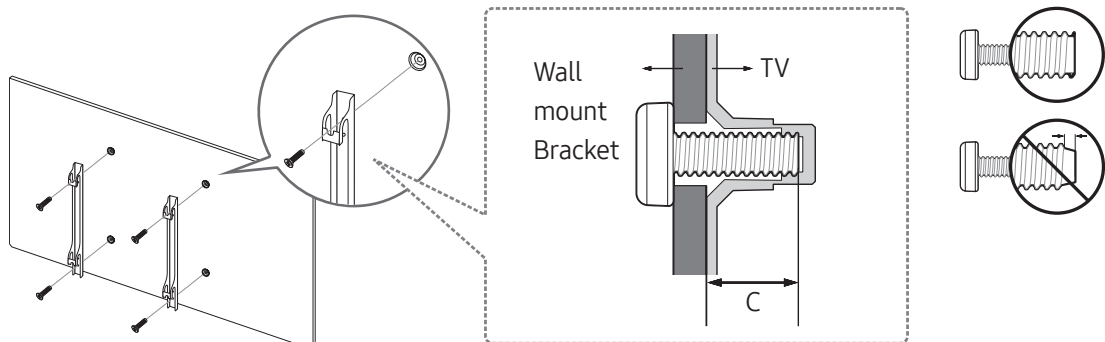

VESA wall mount kit notes and specifications

You can install your wall mount on a solid wall perpendicular to the floor. Before attaching the wall mount to surfaces other than plaster board, contact your nearest dealer for additional information. If you install the TV on a ceiling or slanted wall, it may fall and result in severe personal injury.

- Standard dimensions for wall mount kits are shown in the table below.
- When purchasing our wall mount kit, a detailed installation manual and all parts necessary for assembly are provided.
- Do not use screws that do not comply with the VESA standard screw specifications.
- Do not use screws that are longer than the standard length or do not comply with VESA standard screw specifications. Screws that are too long may cause damage to the inside of the TV set.
- For wall mounts that do not comply with the VESA standard screw specifications, the length of the screws may differ depending on the wall mount specifications.
- Do not fasten the screws too firmly. This may damage the product or cause the product to fall, leading to personal injury. Samsung is not liable for these kinds of accidents.
- Samsung is not liable for product damage or personal injury when a non-VESA or non-specified wall mount is used or the consumer fails to follow the product installation instructions.
- Do not mount the TV at more than a 15 degree tilt.

When using a third-party wall mount, note that the assembling screw length(C) is shown below.

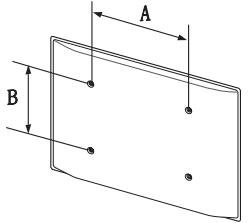
| Product Family | Inches | VESA Spec. (A * B) | C (mm) | Standard Screw | Quantity | |
|----------------|---------|--------------------|---------|----------------|----------|--------------------------------------------------------------------------------------|
| FHD-TV | 40 - 49 | 200 x 200 | 20 ~ 21 | M8 | 4 |  |



Do not install your wall mount kit while your TV is turned on. This may result in personal injury from electric shock.

Providing proper ventilation for your TV

When you install your TV, maintain a distance of at least 10 cm between the TV and other objects (walls, cabinet sides, etc.) to ensure proper ventilation. Failing to maintain proper ventilation may result in a fire or a problem with the product caused by an increase in its internal temperature. When you install your TV with a stand or a wall mount, we strongly recommend you use parts provided by Samsung Electronics only. Using parts provided by another manufacturer may cause difficulties with the product or result in injury caused by the product falling.

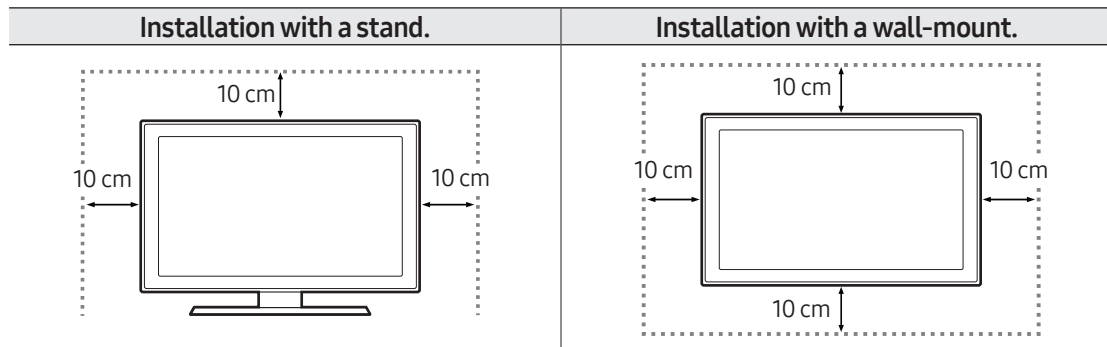

Other Cautions

- The actual appearance of the TV may differ from the images in this manual, depending on the model.
- Be careful when you touch the TV. Some parts can be somewhat hot.

Safety Precaution: Securing the TV to the wall



Caution: Pulling, pushing, or climbing on the TV may cause the TV to fall. In particular, ensure your children do not hang on or destabilise the TV. This action may cause the TV to tip over, causing serious injuries or death. Follow all safety precautions provided in the Safety Flyer included with your TV. For added stability and safety, you can purchase and install the anti-fall device as described below.



WARNING: Never place a television set in an unstable location. The television set may fall, causing serious personal injury or death. Many injuries, particularly to children, can be avoided by taking simple precautions such as

- Using cabinets or stands recommended by the manufacturer of the television set.
- Only using furniture that can safely support the television set.
- Ensuring the television set is not overhanging the edge of the supporting furniture.
- Not placing the television set on tall furniture (for example, cupboards or bookcases) without anchoring both the furniture and the television set to a suitable support.
- Not placing the television set on cloth or other materials that may be located between the television set and supporting furniture.

Educating children about the dangers of climbing on furniture to reach the television set or its controls.

If you are retaining and relocating the television set that you are replacing with this new set, you should apply the same precautions to the old set.

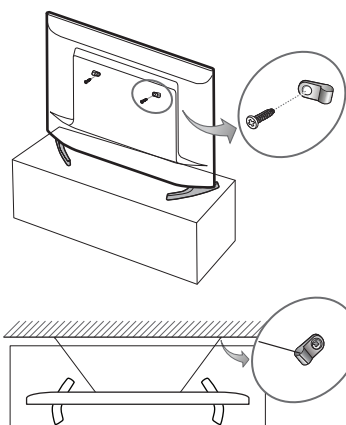

Preventing the TV from falling

1. Put the screws into one set of brackets, and then firmly fasten them to the wall. Confirm that the screws are firmly attached to the wall.
 - You may need additional material such as wall anchors depending on the type of wall.
2. Put the screws into a second set of brackets, and then fasten the screws to the TV.
 - For the screw specifications, refer to the standard screw part in the table under "VESA wall mount kit notes and specifications".
3. Connect the brackets fixed to the TV and the brackets fixed to the wall with a durable, heavy-duty string, and then tie the string tightly.
 - Install the TV near the wall so that it does not fall backwards.
 - Connect the string so that the brackets fixed to the wall are at the same height as or lower than the brackets fixed to the TV.



Anti-theft Kensington Lock

The Kensington Lock is not supplied by Samsung. It is a device used to physically fix the system when using it in a public place. The appearance and locking method may differ from the illustration depending on the manufacturer. Refer to the manual provided with the Kensington Lock for additional information on proper use.

- Please find a “” icon on the rear of the TV. A kensington slot is beside the “” icon.
- The position and colour may differ depending on the model.

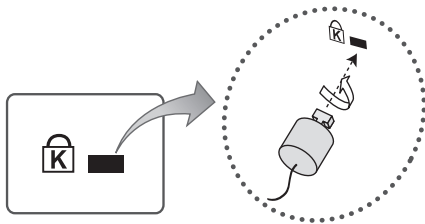

<Optional>

To lock the product, follow these steps:

1. Wrap the Kensington lock cable around a large, stationary object such as desk or chair.
2. Slide the end of the cable with the lock attached through the looped end of the Kensington lock cable.
3. Insert the locking device into the Kensington slot on the product.
4. Lock the lock.
 - These are general instructions. For exact instructions, see the User manual supplied with the locking device.
 - The locking device has to be purchased separately.

03 Connections

Connecting devices to your TV

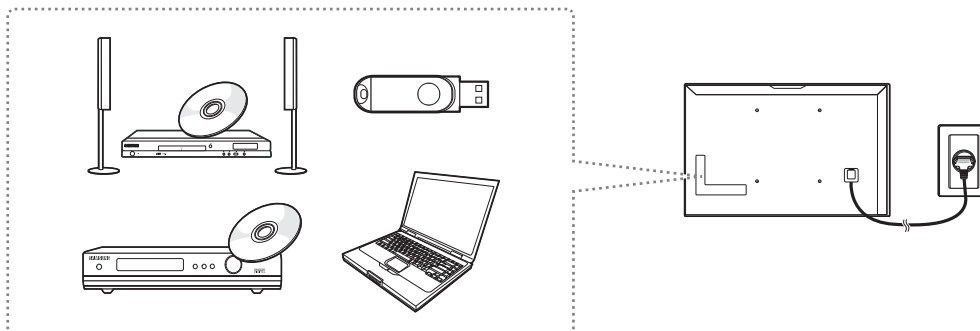

You can connect various external devices using the connectors located at the back of the product. Check the connectors and then refer to the Quick Guide for more instructions on supported external devices.

For more information about connections, see the **e-Manual** chapter "**Connections.**"

Make sure you have the correct cable before plugging it in. Illustrations of common plugs and ports are shown below.

| | Cable Plugs | Ports | | |
|---------|-------------|-------|--|--------------------------------------------------------------------------------------------------------|
| HDMI | | | | |
| USB | | | | |
| Optical | | | | Do not plug cables in upside down. Be sure to check the orientation of the plug before plugging it in. |

Connecting to a COMMON INTERFACE slot (Your TV viewing Card Slot)

- Depending on the country and model.
- Turn the TV off to connect or disconnect a CI card.

Using the “CI or CI+ CARD”

To watch paid channels, the “CI or CI+ CARD” must be inserted.

- If you don't insert the “CI or CI+ CARD”, some channels will display the message “Scrambled Signal”.
- The pairing information containing a telephone number, the “CI or CI+ CARD” ID the Host ID and other information will be displayed in about 2~3 minutes. If an error message is displayed, please contact your service provider.
- When the configuration of channel information has finished, the message “Updating Completed” is displayed, indicating the channel list is updated.

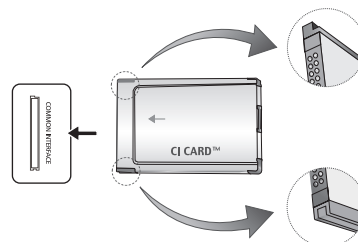

The image may differ depending on the model.

- You must obtain a “CI or CI+ CARD” from a local cable service provider.
- When removing the “CI or CI+ CARD”, carefully pull it out with your hands since dropping the “CI or CI+ CARD” may cause damage to it.
- Insert the “CI or CI+ CARD” in the direction marked on the card.
- The location of the COMMON INTERFACE slot may be different depending on the model.
- “CI or CI+ CARD” is not supported in some countries and regions; check with your authorised dealer.
- If you have any problems, please contact a service provider.
- Insert the “CI or CI+ CARD” that supports the current aerial settings. The screen will be distorted or will not be seen.

04 Network Connection

- Some dongles(RALINK) may not be supported by our product. You need to use other dongle(QCA) for normal working.

Connect the TV to the Internet using a standard router or modem. To connect wirelessly, you must first attach a “Samsung Wireless LAN Adapter” (WIS09ABGNX or WIS12ABGNX - sold separately) to either the USB port on your TV. See the illustration below.

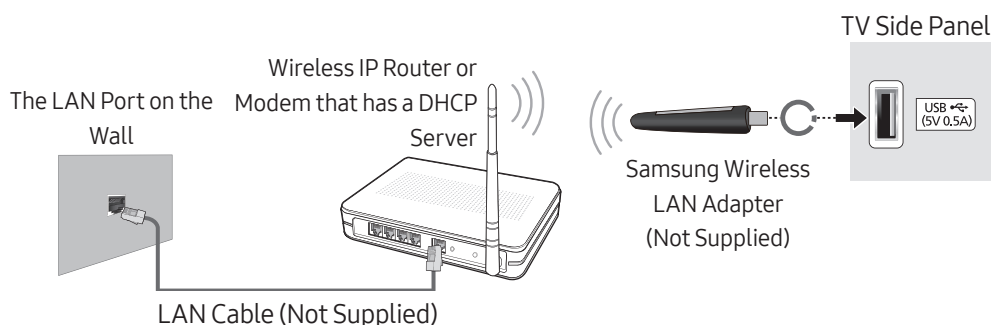

Wireless Network Precautions

- Samsung’s Wireless LAN adapter supports the IEEE 802.11a/b/g and n communication protocols. Samsung recommends using IEEE 802.11n. When you play the video over a IEEE 802.11b/g connection, the video may not play smoothly.
- To use a wireless network, the TV must be connected to a wireless router or modem. If the wireless router supports DHCP, the TV can use a DHCP or static IP address to connect to the wireless network.
- Select a channel that is not currently in use for the wireless router. If the channel set for the wireless router is currently being used by another device, the result is usually interference and/or a communications failure.
- Most wireless networks have an optional security system. To enable a wireless network’s security system, you need to create a security key using characters and numbers. This security key is then needed to connect to the wireless network.

Network Security Protocols

- The TV only supports the following wireless network security protocols and is unable to connect to non-certified wireless routers:
 - Authentication Modes: WEP, WPAPSK, WPA2PSK
 - Encryption Types: WEP, TKIP, AES
- If the wireless router has been set to Pure High-throughput (Greenfield) 802.11n mode and the Encryption Type to WEP or TKIP, Samsung Smart TVs will not support the connection in compliance with the new Wi-Fi certification specifications.
- If the wireless router supports WPS (Wi-Fi Protected Setup), it is possible to connect to the network using PBC (Push Button Configuration) or a PIN (Personal Identification Number). WPS automatically configures the SSID and WPA key settings.

05 The TV Controller

Using the TV Controller

- The product colour and shape may vary depending on the model.
- You can turn on the TV with the **TV Controller** button at the bottom of the TV, and then use the **Control Menu**. The Control Menu appears when the button is pressed while the TV is On. For more information about its usage, refer to the figure below.

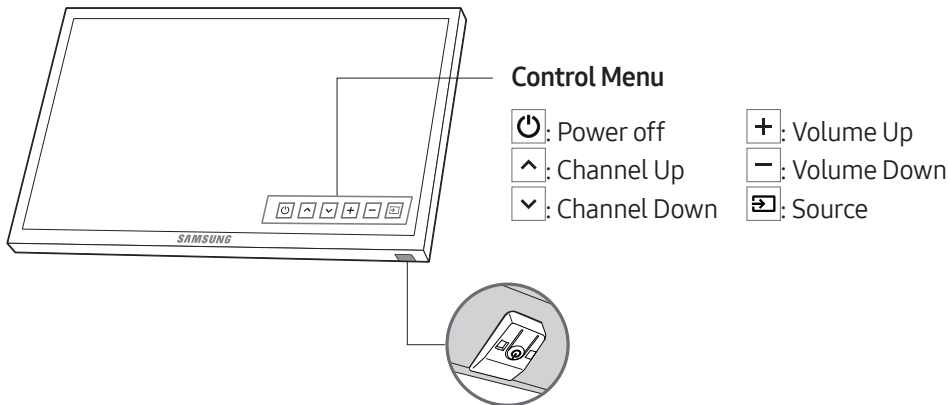

TV Controller / Remote control sensor

Press: Move

Press & Hold: Select

The **TV Controller** is placed at the bottom of the TV.

The Remote Control

Learn where the function buttons are on your remote, such as: **SOURCE**, **MUTE**, **TTX/MIX**, **PRE-CH**, **▼ CH ▲**, **↵**, **CH LIST**, **MENU**, **TOOLS**, **INFO**, **RETURN** and **EXIT**.

- This remote control has Braille points on the **Power**, **Channel**, **Volume**, and **Enter** buttons and can be used by visually impaired persons.

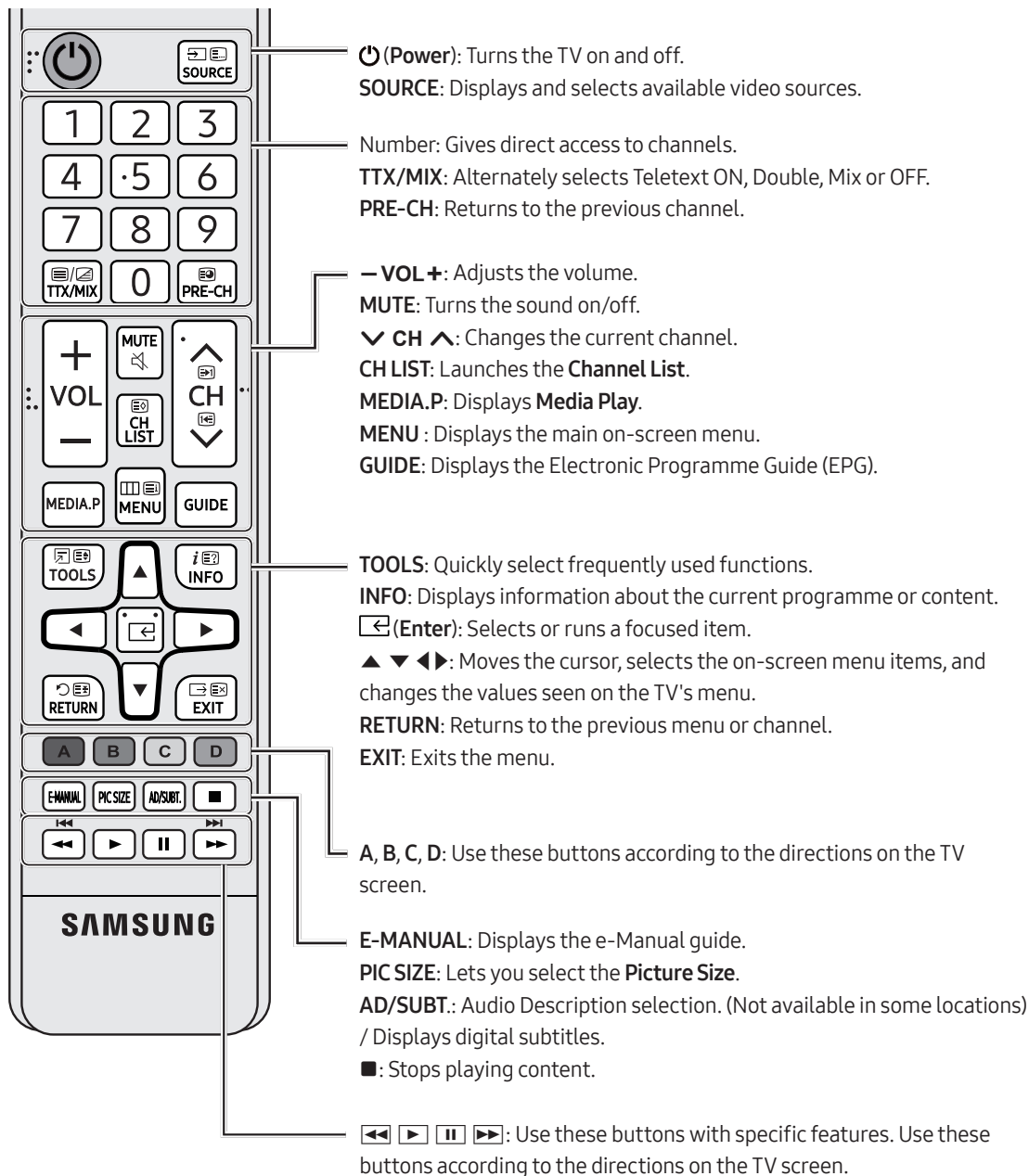

- The button names above may be differ from the actual names.

Installing batteries into the remote control (Battery size: AAA)

Match the polarities of the batteries to the symbols on the battery compartment.

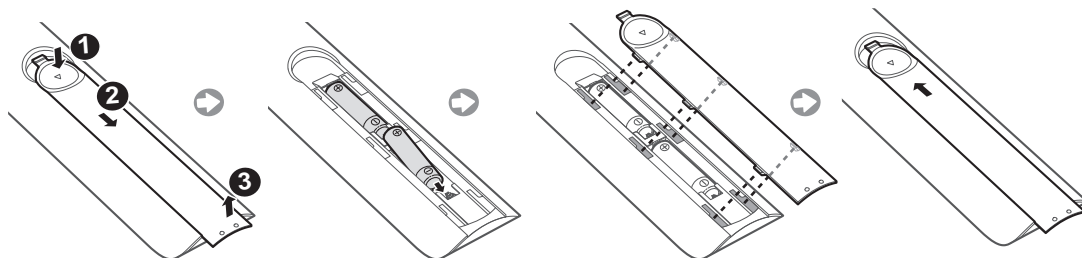

- The colour and shape of the remote may vary depending on the model.
- Use the remote control within 7 m of the TV.
- Bright lights may affect the performance of the remote control. Avoid using the remote control near special fluorescent lights or neon signs.

Teletext Feature

The index page of the Teletext service gives you information on how to use the service. For Teletext information to be displayed correctly, channel reception must be stable. Otherwise, information may be missing or some pages may not be displayed.

- You can change Teletext pages by pressing the numeric buttons on the remote control.

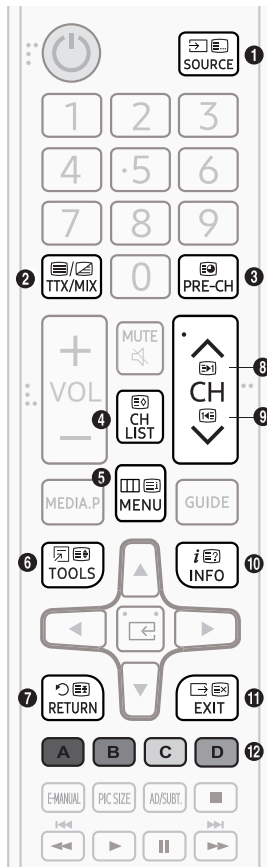

- 1** (mode): Selects the Teletext mode (LIST/FLOF). If pressed during LIST mode, switches the mode to List save mode. In List save mode, you can save a Teletext page into a list using the (store) button.
- 2** (Full TTX/Double TTX/mix/off): Activates the Teletext mode for the current channel. Press the button twice to overlap the Teletext mode with the current broadcasting screen. Press it one more time to exit teletext.
- 3** (sub-page): Displays the available sub-page.
- 4** (store): Stores the Teletext pages.
- 5** (index): Displays the index (contents) page at any time while you are viewing Teletext.
- 6** (size): Displays the teletext on the upper half of the screen in double-size. To move the text to the lower half of the screen, press it again. For normal display, press it once again.
- 7** (hold): Holds the display at the current page, in the case that there are several secondary pages that follow automatically. To undo, press it again.
- 8** (page up): Displays the next Teletext page.
- 9** (page down): Displays the previous Teletext page.
- 10** (reveal): Displays the hidden text (answers to quiz games, for example). To display the normal screen, press it again.
- 11** (cancel): Shrinks the Teletext display to overlap with the current broadcast.
- 12** Colour buttons (red, green, yellow, blue): If the FASTEXT system is used by the broadcasting company, the different topics on a Teletext page are colour-coded and can be selected by pressing the coloured buttons. Press the colour corresponding to the topic of your choice. A new colour coded page is displayed. Items can be selected in the same way. To display the previous or next page, press the corresponding coloured button.

The Teletext pages are organized according to six categories

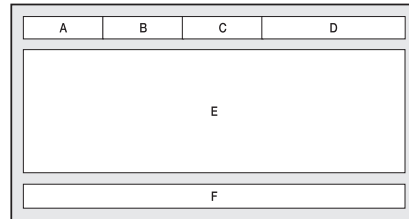

| Part | Contents |
|------|--------------------------------------------|
| A | Selected page number. |
| B | Broadcasting channel identity. |
| C | Current page number or search indications. |
| D | Date and time. |
| E | Text. |
| F | Status information. FASTEXT information. |



06 Performing the initial setup

- The initial setup differs from model to model.
- Turn on the TV using the  button on the remote control or TV controller.

Initial setup

The initial setup dialogue box appears when the TV is first activated. Follow the on-screen instructions to finish the initial setup process such as selecting the menu language, scanning channels, connecting to the network, and more. During each step, either make a choice or skip the step. You can manually perform this process at a later time in the MENU  → System → Setup → ENTER  menu.

- If you connect any external device to HDMI IN (STB) before starting initial setup, the source of your live TV signal is set to **STB**. After finishing with this process, you will not be able to scan all channels and stores them in the TV's memory.
- If you want to connect aerial cable to your TV, select **Aerial**. In this case, you will be able to scan all channels and stores them in the TV's memory.

If You Want to Reset This Feature...

Select **System - Setup** (Initial Setup). Enter your 4 digit PIN number. The default PIN number is "0-0-0-0".

If you want to change the PIN number, use the **Change PIN** function.

You should do **Setup (MENU → System)** again at home even though you did in shop already.

If you forget the PIN code, press the remote control buttons in the following sequence in Standby mode, which resets the PIN to "0-0-0-0": **MUTE → 8 → 2 → 4 → POWER (on)**

07 Selecting Connected Devices

You can select a connected external device using the **SOURCE** button.

For example, to switch to a gaming console connected to the second HDMI connector, press **SOURCE**. From the **Source** list, select **HDMI2** to change the input signal to HDMI mode. Connector names may vary depending on the model.

The following options are available in the **Source** screen:

TOOLS Button

Select a port connected to an external device, and press and hold the Enter button. The following functions are available:

- Available options for each connector may vary.

Edit Name

Rename devices connected to the TV for easier identification of external sources.

For example, you can designate a computer connected to the TV via an HDMI-DVI cable as **DVI PC**.

Alternatively, simply designate a computer connected to the TV via an HDMI cable as **PC**.

You can also designate an AV device connected to the TV via an HDMI-DVI cable as **DVI Devices**.

Information

View detailed information about the connected devices.

08 Getting more details.

For more information about the Samsung TV, refer to the **e-Manual**.

How to use the e-Manual



You can find instructions about your TV's features in the **e-Manual** in your TV. To use, press the **E-MANUAL** button on your remote. Move the cursor using the up/down/right/left buttons to highlight a category, then a topic, and then press the **ENTER** button. The **e-Manual** displays the page you want to see.

You can also access it through the menu:

- **MENU** → **Support** → **e-Manual** → **ENTER**
- To return to the **e-Manual** main menu, press the **E-MANUAL** button on the remote.

Screen Display

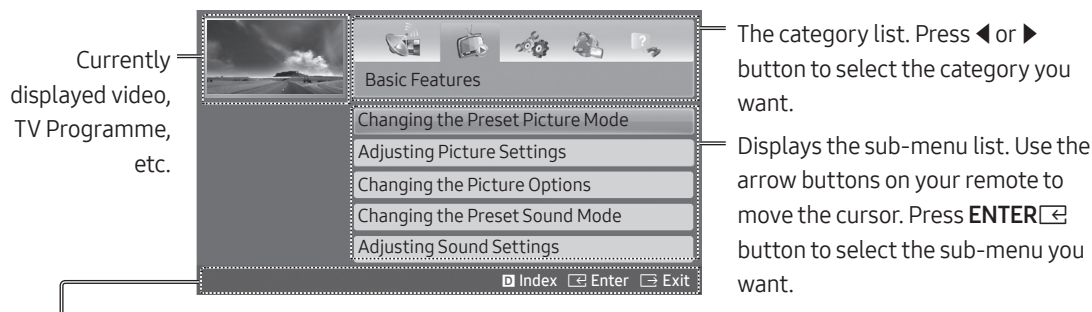

Operation Buttons

- ▣ **Index**: Displays the index screen.
 - Index available depending on the language.
- ↵ **Enter**: Selects a category or sub-menu.
- ↶ **Exit**: Exit the e-Manual.

<Viewing the Contents>

- ▲ **Try now**: Displays the OSD menu that corresponds to the topic. To return to the e-Manual screen, press the **E-MANUAL** button.
- 🏠 **Home**: Moves to the e-Manual home screen.
- ◀▶ **Page**: Moves to previous or next page.
- 🔍 **Zoom**: Magnifies a screen.
 - Press the 🔍 (**Zoom**) button to magnify the screen. You can scroll through the magnified screen by using the ▲ or ▼ buttons. To return to the screen to normal size, press the **RETURN** button.

How to toggle between an e-Manual topic and the corresponding OSD menu(s).

- This function is not enabled in some menus.
- You cannot use the **Try now** function if the menu is not activated.

| Method 1 | Method 2 |
|-------------------------------------------------------------------------------------------------------------------------------------------------------------------------------------------------------------------------------------------------------------------|----------------------------------------------------------------------------------------------------------------------------------------------------------------------------------------------------------------------------------------------------------------------------------------------------------------------|
| <ol style="list-style-type: none">1. If you want to use the menu that corresponds to an e-Manual topic, press the red button to select Try now.2. To return to the e-Manual screen, press the E-MANUAL button. | <ol style="list-style-type: none">1. Press the ENTER button when a topic is displayed. “Are you sure?” appears. Select Yes, and then press the ENTER button. The OSD window appears.2. To return to the e-Manual screen, press the E-MANUAL button. |

How to search for a topic on the index page

- This function may not be supported depending on the language.
1. If you want to search a keyword, press the blue button to select **Index**.
 2. Press the ◀ or ▶ button to select a character order you want.
 3. Press the ▲ or ▼ button to select a keyword you want to see, and then press the **ENTER** button.
 4. You can view the corresponding e-Manual instruction screen.
 - To close the **Index** screen, press the **RETURN** button.

09 Troubleshooting and Maintenance

Troubleshooting

If the TV seems to have a problem, first try this list of possible problems and solutions. If none of these troubleshooting tips apply, visit “www.samsung.com”, then click on Support, or call Samsung customer service centre.

Picture Quality

- First of all, please perform the **Picture Test** and confirm that your TV is properly displaying test image. (go to **MENU - Support - Self Diagnosis - Picture Test**) If the test image is properly displayed, the poor picture may be caused by the source or signal.

The TV image does not look as good as it did in the store.

- If you have an analogue cable/set top box, upgrade to a digital set top box. Use HDMI or Component cables to deliver HD (high definition) picture quality.
- Cable/Satellite subscribers: Try digital stations from the channel line up.
- Aerial connection: Try HD stations after performing Auto tuning.
- Many HD channels are up scaled from SD (Standard Definition) contents.
- Adjust the Cable/Set top box video output resolution to 1080i or 720p.
- Make sure you are watching the TV at the minimum recommended distance based on the size and definition of the signal.

The picture is distorted: macro block, small block, dots, pixelization error.

- Compression of video contents may cause picture distortion especially in fast moving pictures such as sports and action movies.
- Low signal level or bad quality can cause picture distortion. This is not a TV issue.
- Mobile phones used close to the TV (cca up to 1m) may cause noise in picture on analogue and digital TV.

Colour is wrong or missing.

- If you're using a component connection, make sure the component cables are connected to the correct jacks. Incorrect or loose connections may cause colour problems or a blank screen.

There is poor colour or brightness.

- Adjust the **Picture** options in the TV menu. (go to **Picture Mode / Colour / Brightness / Sharpness**)
- Adjust **Energy Saving** option in the TV menu. (go to **MENU - System - Eco Solution - Energy Saving**)
- Try resetting the picture to view the default picture settings. (go to **MENU - Picture - Reset Picture**)

There is a dotted line on the edge of the screen.

- If the picture size is set to **Screen Fit**, change it to **16:9**.
- Change cable/satellite box resolution.

The picture is black and white.

- If you are using an AV composite input, connect the video cable (yellow) to the Green jack of component input 1 on the TV.

When changing channels, the picture freezes or is distorted or delayed.

- If connected with a cable box, please try to reset the cable box. Reconnect the AC cord and wait until the cable box reboots. It may take up to 20 minutes.
- Set the output resolution of the cable box to 1080i or 720p.

Sound Quality

- First of all, please perform the **Sound Test** to confirm that your TV audio is properly operating. (go to **MENU - Support - Self Diagnosis - Sound Test**)
- If the audio is ok, the sound problem may be caused by the source or signal.

There is no sound or the sound is too low at maximum volume.

- Please check the volume of the device (Cable/Sat Box, DVD, Blu-ray etc) connected to your TV.

The picture is good but there is no sound.

- Set the **Speaker Select** option to **TV Speaker** in the sound menu.
- If you are using an external device, make sure the audio cables are connected to the correct audio input jacks on the TV.
- If you are using an external device, check the device's audio output option (ex. you may need to change your cable box's audio option to HDMI when you have a HDMI connected to your TV).
- If you are using a DVI to HDMI cable, a separate audio cable is required.
- Reboot the connected device by reconnecting the device's power cable.

The speakers are making an inappropriate noise.

- Check the cable connections. Make sure a video cable is not connected to an audio input.
- For aerial or cable connections, check the signal strength. Low signal level may cause sound distortion.

No Picture, No Video

The TV will not turn on.

- Make sure the AC power cord is securely plugged in to the wall outlet and the TV.
- Make sure the wall outlet is working.
- Try pressing the **POWER** button on the TV to make sure the problem is not the remote. If the TV turns on, refer to "The remote control does not work" below.

The TV turns off automatically.

- Ensure the **Sleep Timer** is set to **Off** in the **Time** menu.
- If your PC is connected to the TV, check your PC power settings.
- Make sure the AC power cord is plugged in securely to the wall outlet and the TV.
- **No Signal Power Off** turns off the TV if no signal has been received by the TV for a specified period time. **Auto Power Off** turns off the TV if there has been no user input in four hours.

There is no picture/video.

- Check cable connections (remove and reconnect all cables connected to the TV and external devices).
- Set your external device's (Cable/Set top Box, DVD, Blu-ray etc) video outputs to match the connections to the TV input. For example, if an external device's output is HDMI, it should be connected to an HDMI input on the TV.
- Make sure your connected devices are powered on.
- Be sure to select the TV's correct source by pressing the **SOURCE** button on the remote control.
- Reboot the connected device by reconnecting the device's power cable.

Aerial (Air/Cable) Connection (Cable: depending on the country)

The TV is not receiving all channels.

- Make sure the Aerial cable is connected securely.
- Please try **Setup** (Initial setup) to add available channels to the channel list. Go to **MENU - System - Setup** (Initial setup) and wait for all available channels to be stored.
- Verify the Aerial is positioned correctly.

The picture is distorted: macro block, small block, dots, pixelization error.

- Compression of video contents may cause picture distortion, especially on fast moving pictures such as sports and action movies.
- A low signal can cause picture distortion. This is not a TV issue.

Others

The picture will not display in full screen.

- HD channels will have black bars on either side of the screen when displaying up scaled SD (4:3) contents.
- Black bars on the top and bottom will appear during movies that have aspect ratios different from your TV.
- Adjust the picture size options on your external device or TV to full screen.

The remote control does not work.

- Replace the remote control batteries with the poles (+/-) in the right direction.
- Clean the sensor's transmission window on the remote.
- Try pointing the remote directly at the TV from 5~6 feet away.

The cable/set top box remote control doesn't turn the TV on or off, or adjust the volume.

- Programme the Cable/Set top box remote control to operate the TV. Refer to the Cable/Set top box user manual for the SAMSUNG TV code.

A "Mode Not Supported" message appears.

- Check the supported resolution of the TV, and adjust the external device's output resolution accordingly.

There is a plastic smell from the TV.

- This smell is normal and will dissipate over time.

The TV Signal Information is unavailable in the Self Diagnosis Test menu.

- This function is only available with digital channels from an Aerial / RF / Coax connection.

TV is tilted to the right or left side.

- Remove the stand base from the TV and reassemble it.

There are difficulties assembling the stand base.

- Make sure the TV is placed on a flat surface. If you can not remove the screws from the TV, please use a magnetised screw driver.

The Broadcasting menu is grey out (unavailable).

- The **Broadcasting** menu is only available when the TV source is selected.

Your settings are lost after 5 minutes or every time the TV is turned off.

- If the TV is in the **Store Demo** mode, it will reset audio and picture settings every 5 minutes. If you want to change the settings from **Store Demo** mode to **Home Use**, press the **SOURCE** button to select **TV** mode, and go to **MENU - Support - Use Mode**.

You have intermittent loss of audio or video.

- Check the cable connections and reconnect them.
- Loss of audio or video can be caused by using overly rigid or thick cables. Make sure the cables are flexible enough for long term use. If mounting the TV to the wall, we recommend using cables with 90 degree connectors.

You see small particles when you look closely at the edge of the frame of the TV.

- This is part of the product's design and is not a defect.

The PIP menu is not available.

- **PIP** functionality is only available when you are using a HDMI or components source.

You turned the TV off 45 minutes ago, and it turned on again.

- It is normal. The TV operates the OTA (Over The Aerial) function itself to upgrade firmware downloaded whilst your watching TV.

There are recurrent picture/sound issues.

- Check and change the signal/source.

A reaction may occur between the rubber cushion pads on the base stand and the top finish of some furniture.

- To prevent this, use felt pads on any surface of the TV that comes in direct contact with furniture.

The message "This file may not be playable properly." appears.

- This may appear because of high bit rate of content. Content generally will play but could experience some playability issue.

You can keep your TV in optimum operating condition by upgrading to the latest firmware (www.samsung.com → Support) by USB.

This TFT LED panel uses a panel consisting of sub pixels which require sophisticated technology to produce. However, there may be a few bright or dark pixels on the screen. These pixels will have no impact on the performance of the product.

Some functions and pictures shown in this manual are available on specific models only.

Caring for the TV

- If a sticker was attached to the TV screen, some debris can remain after you remove the sticker. Please clean the debris off before watching TV.
- The exterior and screen of the TV can get scratched during cleaning. Be sure to wipe the exterior and screen carefully using a soft cloth to prevent scratches.
- Do not spray water or any liquid directly onto the TV. Any liquid that goes into the product may cause a failure, fire, or electric shock.
- Turn off the TV, then gently wipe away smudges and fingerprints on the screen with a micro-fiber cloth. Clean the body of the TV with a soft cloth dampened with a small amount of water. Do not use flammable liquids (benzene, thinners, etc.) or a cleaning agent. For stubborn smudges, spray a small amount of screen cleaner on the cloth.

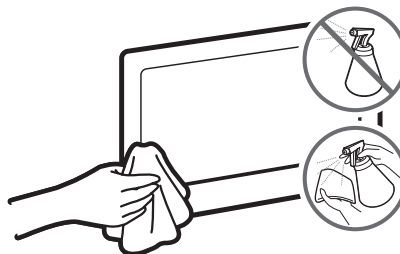

Still image warning

Avoid displaying still images (such as jpeg picture files), still image elements (such as TV channel logos, stock or news crawls at the screen bottom etc.), or programmes in panorama or 4:3 image format on the screen. If you constantly display still pictures, it can cause image burn-in on the LED screen and affect image quality. To reduce the risk of this adverse effect, please follow the recommendations below:

- Avoid displaying the same TV channel for long periods.
- Always try to display any image in full screen. Use the picture format menu of the TV for the best possible match.
- Reduce brightness and contrast to avoid the appearance of after-images.
- Use all TV features designed to reduce image retention and screen burn. Refer to the e-Manual for details.

10 Specifications and other information

TV Specifications

| | | |
|------------------------------------|--------------------------|---------------------------|
| Model Name | UE40M5000 | UE49M5000 |
| Display Resolution (pixel) | 1920 x 1080 | 1920 x 1080 |
| Screen Size (Diagonal) | 40 inches (100 cm) | 49 inches (123 cm) |
| Sound (Output) | 20 W | 20 W |
| Stand Swivel (Left / Right) | 0° | 0° |
| Dimensions (W x H x D) | | |
| Body | 922.7 x 531.0 x 72.6 mm | 1118.8 x 650.0 x 74.2 mm |
| With stand | 922.7 x 552.5 x 170.3 mm | 1118.8 x 669.9 x 187.5 mm |
| Weight | | |
| Without Stand | 7.0 kg | 10.3 kg |
| With Stand | 7.2 kg | 10.6 kg |

Environmental Considerations

| | |
|------------------------------|-------------------------------|
| Operating Temperature | 50°F to 104°F (10°C to 40°C) |
| Operating Humidity | 10% to 80%, non-condensing |
| Storage Temperature | -4°F to 113°F (-20°C to 45°C) |
| Storage Humidity | 5% to 95%, non-condensing |

- The design and specifications are subject to change without prior notice.
- For information about the power supply, and about power consumption, refer to the label attached to the product.
- Typical power consumption is measured according to IEC 62087.

Decreasing power consumption

When you shut the TV off, it enters Standby mode. In Standby mode, it continues to draw a small amount of power. To decrease power consumption, unplug the power cord when you don't intend to use the TV for a long time.

Supported Video Formats

| File Extention | Container | Video Codec | Resolution | Frame rate (fps) | Bit rate (Mbps) | Audio Codec | |
|-----------------------------------------------------------------------------------------------------------------------------------------------|-----------|----------------------------------------|-------------|------------------|-----------------|-----------------------------------------------------------------------------|--|
| *.avi / *.mkv *.asf / *.wmv *.mp4 / *.3gp *.vro / *.mpg *.mpeg / *.ts *.tp / *.trp *.mov / *.flv *.vob / *.svi *.divx | AVI | DivX 3.11 / 4 / 5 / 6 | 1920 x 1080 | 6 ~ 30 | 30 | Dolby Digital LPCM ADPCM (IMA, MS) AAC HE-AAC WMA | |
| | | MPEG4 SP/ASP | | | | | |
| | | H.264 BP/MP/HP | | | | | |
| | MKV | HEVC (H.265 - Main, Main10 - L4, L4.1) | 640 x 480 | | 8 | Dolby Digital Plus MPEG (MP3) DTS (Core) G.711 (A-Law, μ -Law) | |
| | ASF | Motion JPEG | | | | | |
| | MP4 | Window Media Video v9 | | | 1920 x 1080 | 30 | |
| | 3GP | MPEG2 | | | | | |
| | VRO | MPEG1 | | | | | |
| | VOB | | | | | | |
| | PS | | | | | | |
| TS | | | | | | | |

Other Restrictions

- Video content will not play, or not play correctly, if there is an error in the content or the container.
- Sound or video may not work if the contents have a standard bit rate/frame rate above the compatible Frame/sec listed in the table.
- If the Index Table is in error, the Seek (Jump) function is not supported.
- Some USB/digital camera devices may not be compatible with the player.
- The menu can be displayed late if the video is over 10Mbps(bit rate).
- HEVC codec is only available in MKV/MP4/TS containers.

Video decoder

- Supports up to H.264, Level 4.1 (FMO/ASO/RS are not supported.)
- Supports up to H.265 - Main, Main10 - L4, L4.1
- frame rate:
 - Below 1280 x 720: 60 frame max
 - Above 1280 x 720: 30 frame max
- VC1 AP L4 is not supported.
- GMC 2 or higher is not supported.

Audio decoder

- WMA 10 Pro supports up to 5.1 channel and M2 profile.
- WMA lossless audio is not supported.
- Vorbis supports up to 2ch.
- Dolby Digital Plus supports up to 5.1 channel.

Supported Subtitle Formats

External

| Name | File extension |
|---------------------------|----------------|
| MPEG-4 timed text | .txt |
| SAMI | .smi |
| SubRip | .srt |
| SubViewer | .sub |
| Micro DVD | .sub or .txt |
| SubStation Alpha | .ssa |
| Advanced SubStation Alpha | .ass |
| Powerdivx | .psb |

Internal

| Name | Container | Format |
|---------------------------|-----------|----------------|
| Xsub | AVI | Picture Format |
| SubStation Alpha | MKV | Text Format |
| Advanced SubStation Alpha | MKV | Text Format |
| SubRip | MKV | Text Format |
| MPEG-4 Timed text | MP4 | Text Format |

Supported Photo Formats

| File Extension | Type | Resolution |
|----------------|------|--------------|
| *.jpg / *.jpeg | JPEG | 15360 x 8640 |
| *.bmp | BMP | 4096 x 4096 |
| *.mpo | MPO | 15360 x 8640 |

- The MPO type file does not support Zoom, Rotate and Slide Show Effect functions.

Supported Music Formats

| File Extension | Type | Codec | Remark |
|-----------------------|-------|---------------------|----------------------------------------------------------------------------------------------|
| *.mp3 | MPEG | MPEG1 Audio Layer 3 | |
| *.m4a / *.mpa / *.aac | MPEG4 | AAC | |
| *.flac | FLAC | FLAC | Supports up to 2ch. |
| *.ogg | OGG | Vorbis | Supports up to 2ch. |
| *.wma | WMA | WMA | WMA 10 Pro supports up to 5.1 channel and M2 profile. (WMA lossless audio is not supported.) |
| *.wav | wav | wav | |
| *.mid / *.midi | midi | midi | type 0 and type 1 |

Full available resolution

Optimal resolution is 5 series: 1920 x 1080@60Hz. See specification page for full available resolution.

| Mode | Resolution | Horizontal Frequency (KHz) | Vertical Frequency (Hz) | Pixel Clock Frequency (MHz) | Sync Polarity (H / V) | 1920 x 1080 |
|-------------|--------------|----------------------------|-------------------------|-----------------------------|-----------------------|-------------|
| IBM | 720 x 400 | 31.469 | 70.087 | 28.322 | -/+ | ✓ |
| MAC | 640 x 480 | 35.000 | 66.667 | 30.240 | -/- | ✓ |
| | 832 x 624 | 49.726 | 74.551 | 57.284 | -/- | ✓ |
| | 1152 x 870 | 68.681 | 75.062 | 100.000 | -/- | ✓ |
| VESA DMT | 640 x 480 | 31.469 | 59.940 | 25.175 | -/- | ✓ |
| | 640 x 480 | 37.861 | 72.809 | 31.500 | -/- | ✓ |
| | 640 x 480 | 37.500 | 75.000 | 31.500 | -/- | ✓ |
| | 800 x 600 | 37.879 | 60.317 | 40.000 | +/+ | ✓ |
| | 800 x 600 | 48.077 | 72.188 | 50.000 | +/+ | ✓ |
| | 800 x 600 | 46.875 | 75.000 | 49.500 | +/+ | ✓ |
| | 1024 x 768 | 48.363 | 60.004 | 65.000 | -/- | ✓ |
| | 1024 x 768 | 56.476 | 70.069 | 75.000 | -/- | ✓ |
| | 1024 x 768 | 60.023 | 75.029 | 78.750 | +/+ | ✓ |
| | 1152 x 864 | 67.500 | 75.000 | 108.000 | +/+ | ✓ |
| | 1280 x 720 | 45.000 | 60.000 | 74.250 | +/+ | ✓ |
| | 1280 x 800 | 49.702 | 59.810 | 83.500 | -/+ | ✓ |
| | 1280 x 1024 | 63.981 | 60.020 | 108.000 | +/+ | ✓ |
| | 1280 x 1024 | 79.976 | 75.025 | 135.000 | +/+ | ✓ |
| | 1366 x 768 | 47.712 | 59.790 | 85.500 | +/+ | ✓ |
| | 1440 x 900 | 55.935 | 59.887 | 106.500 | -/+ | ✓ |
| | 1600 x 900RB | 60.000 | 60.000 | 108.000 | +/+ | ✓ |
| 1680 x 1050 | 65.290 | 59.954 | 146.250 | -/+ | ✓ | |
| 1920 x 1080 | 67.500 | 60.000 | 148.500 | +/+ | ✓ | |

- The interlace mode is not supported.
- The set might operate abnormally if a non-standard video format is selected.

Licences



For DTS patents, see <http://patents.dts.com>. Manufactured under license from DTS, Inc. DTS, the Symbol, DTS in combination with the Symbol, DTS Premium Sound|5.1, DTS Digital Surround, DTS Express, and DTS Neo2:5 are registered trademarks or trademarks of DTS, Inc. in the United States and/or other countries.

© DTS, Inc. All Rights Reserved.



This DivX Certified® device can play DivX® HD video files (including .avi, .divx).

Download free software at www.divx.com to create, play and stream digital videos.

To play purchased DivX movies, first register your device at vod.divx.com. Find your registration code in the DivX VOD section of your device setup menu.

This DivX Certified® device can play DivX® HD video (including .avi, .divx).

DivX®, DivX Certified® and associated logos are trademarks of DivX, LLC and are used under license.

Covered by one or more of the following U.S. patents: 7,295,673; 7,460,668; 7,515,710; 8,656,183; 8,731,369; RE45,052.



The terms HDMI and HDMI High-Definition Multimedia Interface, and the HDMI Logo are trademarks or registered trademarks of HDMI Licensing LLC in the United States and other countries.



Manufactured under license from Dolby Laboratories. Dolby, Dolby Audio, Pro Logic, and the double-D symbol are trademarks of Dolby Laboratories.

Open Source License Notice

Open Source used in this product can be found on the following webpage.

(<http://opensource.samsung.com>) Open Source License Notice is written only English.

Recommendation - EU Only



Hereby, Samsung Electronics, declares that this TV is in compliance with the essential requirements and other relevant provisions of Directive 1999/5/EC.

The official Declaration of Conformity may be found at <http://www.samsung.com>, go to Support > Search Product Support and enter the model name.

This equipment may be operated in all EU countries.



Correct Disposal of This Product (Waste Electrical & Electronic Equipment) (Applicable in countries with separate collection systems)

This marking on the product, accessories or literature indicates that the product and its electronic accessories (e.g. charger, headset, USB cable) should not be disposed of with other household waste at the end of their working life. To prevent possible harm to the environment or human health from uncontrolled waste disposal, please separate these items from other types of waste and recycle them responsibly to promote the sustainable reuse of material resources.

Household users should contact either the retailer where they purchased this product, or their local government office, for details of where and how they can take these items for environmentally safe recycling.

Business users should contact their supplier and check the terms and conditions of the purchase contract. This product and its electronic accessories should not be mixed with other commercial wastes for disposal.



Correct disposal of the batteries in this product (Applicable in countries with separate collection systems)

This marking on battery, manual or packaging indicates that the batteries in this product should not be disposed of with other household waste at the end of their working life. Where marked, the chemical symbols Hg, Cd or Pb indicate that the battery contains mercury, cadmium or lead above the reference levels in EC Directive 2006/66. If batteries are not properly disposed of, these substances can cause harm to human health or the environment.

To protect natural resources and to promote material reuse, please separate batteries from other types of waste and recycle them through your local, free battery return system.

For information on Samsung's environmental commitments and product-specific regulatory obligations, e.g. REACH, WEEE, Batteries, visit http://www.samsung.com/uk/aboutsamsung/samsungelectronics/corporatecitizenship/data_corner.html

WARNING - TO PREVENT THE SPREAD OF FIRE, KEEP CANDLES OR OTHER ITEMS WITH OPEN FLAMES AWAY FROM THIS PRODUCT AT ALL TIMES.



- **WARNINGS:** Image retention, commonly known as screen burn-in, can occur on most types of television if the same image is displayed continuously. The most common causes of image retention are logos that remain stationary on the TV screen. These logos are common on many programmes received via a satellite box. To reduce this risk, avoid displaying still images for long durations and lower the brightness or contrast settings to decrease the intensity of the picture. Extended viewing of movies and programmes in aspect ratios that are different from the aspect ratio of the TV may cause image retention. Always try to avoid black borders at the top or bottom by using the zoom function. This will help eliminate the black borders and fit the picture to the entire area of the screen. Using a video game console may cause image retention and is not recommended. When using a PC input, avoid displaying still images for long durations and reduce the brightness or contrast settings to decrease the intensity of the picture.
- **IMPORTANT:** Image retention issues are not covered by your Samsung® warranty.

Warranty Card



United Kingdom



Republic of Ireland (EIRE)

This Samsung product is warranted for a period of twelve (12) months from the original date of purchase, against defective materials and workmanship. In the event that warranty service is required, you should return the product to the retailer from whom it was purchased. However, Samsung Authorised Dealers and Authorised Service Centres in other EC Countries will comply with the warranty on the terms issued to purchasers in the country concerned. In case of difficulty, details of our Authorised Service Centres are available from:

Samsung Electronics U.K. Ltd
Samsung Customer Support Centre
Selectapost 38, Sheffield, S97 3FJ
United Kingdom

United Kingdom
Tel : 0330 SAMSUNG (7267864)
www.samsung.com/uk/support

EIRE
Tel : 0818 717100
www.samsung.com/ie/support

WARRANTY CONDITIONS

1. The warranty is only valid if, when warranty service is required, the warranty card is fully and properly completed and is presented with the original invoice or sales slip or confirmation, and the serial number on the product has not been defaced.
2. Samsung's obligations are limited to the repair or, at its discretion, replacement of the product or the defective part.
3. Warranty repairs must be carried out by Authorised Samsung Dealers or Authorised Service Centres. No re-imbursment will be made for repairs carried out by non Samsung Dealers and, any such repair work and damage to the products caused by such repair work will not be covered by this warranty.
4. This product is not considered to be defective in materials nor workmanship by reason that it requires adaptation in order to conform to national or local technical or safety standards in force in any country other than the one for which the product was originally designed and manufactured.
5. This warranty covers none of the following:
 - a) Periodic check ups, maintenance and repair or replacement of parts due to normal wear and tear.
 - b) Cost relating to transport, removal or installation of the product.
 - c) Misuse, including the failure to use this product for its normal purposes or incorrect installation.
 - d) Damage caused by Lightning, Water, Fire, Acts of God, War, Public Disturbances, incorrect mains voltage, improper ventilation or any other cause beyond the control of Samsung.
 - e) Spillage of food or liquid or use of any other hazardous substances, which may effect the product.
 - f) Performance due to differences in broadcasting method between countries
6. This warranty is valid for any person who legally acquired possession of the product during the warranty period.
7. The consumers statutory rights in any applicable national legislation whether against the retailer arising from the purchase contract or otherwise are not affected by this warranty. Unless there is national legislation to the contrary, the rights under this warranty are the consumers sole rights and Samsung, its subsidiaries and distributors shall not be liable for indirect or consequential loss or any damage to records, compact discs, videos or audio taper or any other related equipment or material.
8. Some products may differ from these guidelines. Please check with your dealer or the local Samsung web-site.

SAMSUNG



BN68-08544J-00

Contact SAMSUNG WORLD WIDE

If you have any questions or comments relating to Samsung products, please contact the SAMSUNG customer care centre.

| Country | Customer Care Centre ☎ | Web Site |
|---------|------------------------|----------------------------------------------------------------------------|
| EIRE | 0818 717100 | www.samsung.com/ie/support |
| UK | 0330 SAMSUNG (7267864) | www.samsung.com/uk/support |