

SAMSUNG

USER MANUAL

UHD TV 7 SERIES

Thank you for purchasing this Samsung product.



To receive more complete service, please register your product at www.samsung.com

Model _____ Serial No. _____

Before Reading This User Manual

This TV comes with this user manual and an embedded e-Manual.

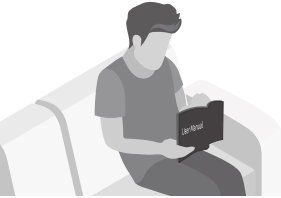
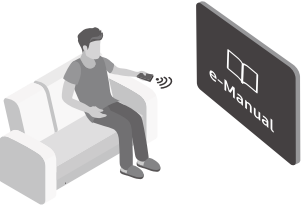

Before reading this user manual, review the following:

	<p>User Manual</p>	<p>Read this provided user manual to see information about product safety, installation, accessories, initial configuration, and product specifications.</p>
	<p>e-Manual</p>	<p>For more information about this TV, read the e-Manual embedded in the product.</p> <ul style="list-style-type: none"> To open the e-Manual, <ul style="list-style-type: none">  >  Settings > Support > Open e-Manual



On the website (www.samsung.com), you can download the manuals and see its contents on your PC or mobile device.

Learning the e-Manual's assistance functions

- Some menu screens cannot be accessed from the e-Manual.

	<p>Search</p>	<p>Select an item from the search results to load the corresponding page.</p>
	<p>Index</p>	<p>Select a keyword to navigate to the relevant page.</p> <ul style="list-style-type: none"> The menus may not appear depending on the geographical area.
	<p>Recent pages</p>	<p>Select a topic from the list of recently viewed topics.</p>

Learning the functions of the buttons that appear on e-Manual topic pages

	<p>Try Now</p>	<p>Allows you to access the corresponding menu item and try out the feature right away.</p>
	<p>Link</p>	<p>Access an underlined topic referred to on an e-Manual page immediately.</p>

Features of your new TV

Home Screen

In Home Screen, you can easily run the apps that have been used previously or frequently. The apps can also be moved or deleted in the screen.

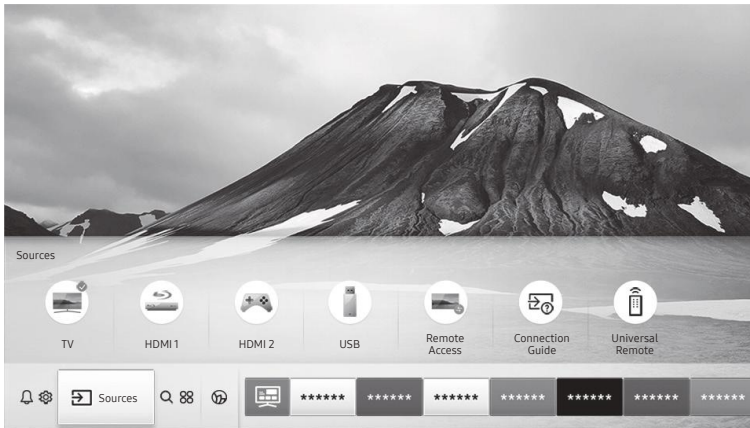

- The image on your TV may differ from the image above depending on the model and geographical area.

e-Manual

Get help from a detailed, on-screen user's manual built into your TV.

Bixby

Access and control menu options and functions using Bixby.

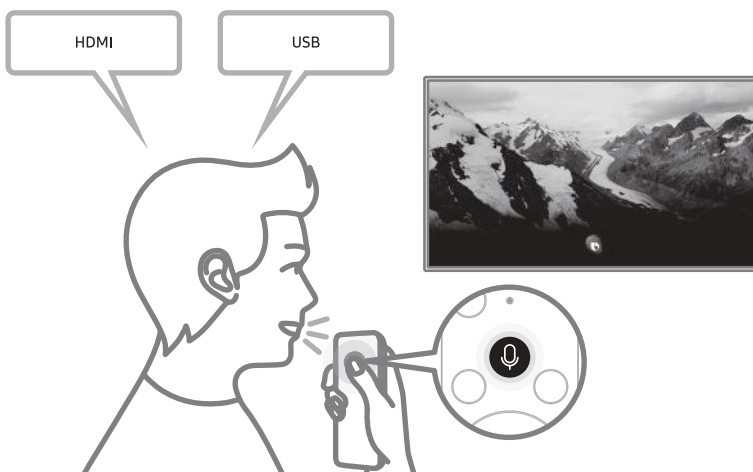







- The image on your TV may differ from the image above depending on the model and geographical area.

Warning! Important Safety Instructions

Please read the Safety Instructions before using your TV.

Refer to the table below for an explanation of symbols which may be on your Samsung product.

CAUTION			Class II product: This symbol indicates that a safety connection to electrical earth (ground) is not required. If this symbol is not present on a product with a mains lead, the product MUST have a reliable connection to protective earth (ground).
RISK OF ELECTRIC SHOCK. DO NOT OPEN.			
CAUTION: TO REDUCE THE RISK OF ELECTRIC SHOCK, DO NOT REMOVE COVER (OR BACK). THERE ARE NO USER SERVICEABLE PARTS INSIDE. REFER ALL SERVICING TO QUALIFIED PERSONNEL.			AC voltage: Rated voltage marked with this symbol is AC voltage.
	This symbol indicates that high voltage is present inside. It is dangerous to make any kind of contact with any internal part of this product.		DC voltage: Rated voltage marked with this symbol is DC voltage.
	This symbol indicates that this product has included important literature concerning operation and maintenance.		Caution. Consult instructions for use: This symbol instructs the user to consult the user manual for further safety related information.

- The slots and openings in the cabinet and in the back or bottom are provided for necessary ventilation. To ensure reliable operation of this apparatus and to protect it from overheating, these slots and openings must never be blocked or covered.
 - Do not place this apparatus in a confined space, such as a bookcase or built-in cabinet, unless proper ventilation is provided.
 - Do not place this apparatus near or over a radiator or heat register, or where it is exposed to direct sunlight.
 - Do not place vessels (vases etc.) containing water on this apparatus, as this can result in a fire or electric shock.

- Do not expose this apparatus to rain or place it near water (near a bathtub, washbowl, kitchen sink, or laundry tub, in a wet basement, or near a swimming pool, etc.). If this apparatus accidentally gets wet, unplug it and contact an authorised dealer immediately.
- This apparatus uses batteries. In your community, there might be environmental regulations that require you to dispose of these batteries properly. Please contact your local authorities for disposal or recycling information.
- Do not overload wall outlets, extension cords, or adaptors beyond their capacity, since this can result in fire or electric shock.
- Power-supply cords should be placed so that they are not likely to be walked on or pinched by items placed upon or against them. Pay particular attention to cords at the plug end, at wall outlets, and at the point where they exit from the appliance.
- To protect this apparatus from a lightning storm, or when left unattended and unused for long periods of time, unplug it from the wall outlet and disconnect the antenna or cable system. This will prevent damage to the set due to lightning and power line surges.
- Before connecting the AC power cord to the DC adaptor outlet, make sure that the voltage designation of the DC adaptor corresponds to the local electrical supply.
- Never insert anything metallic into the open parts of this apparatus. This may cause a danger of electric shock.
- To avoid electric shock, never touch the inside of this apparatus. Only a qualified technician should open this apparatus.
- Be sure to plug in the power cord until it is firmly seated. When unplugging the power cord from a wall outlet, always pull on the power cord's plug. Never unplug it by pulling on the power cord. Do not touch the power cord with wet hands.
- If this apparatus does not operate normally - in particular, if there are any unusual sounds or smells coming from it - unplug it immediately and contact an authorised dealer or service centre.
- Be sure to pull the power plug out of the outlet if the TV is to remain unused or if you are going to leave the house for an extended period of time (especially when children, elderly, or disabled people will be left alone in the house).
 - Accumulated dust can cause an electric shock, an electric leakage, or a fire by causing the power cord to generate sparks and heat or by causing the insulation to deteriorate.

- Be sure to contact an authorised Samsung service centre for information if you intend to install your TV in a location with heavy dust, high or low temperatures, high humidity, chemical substances, or where it will operate 24 hours a day such as in an airport, a train station, etc. Failure to do so may lead to serious damage to your TV.
 - Use only a properly grounded plug and wall outlet.
 - An improper ground may cause electric shock or equipment damage. (Class I Equipment only.)
 - To turn off this apparatus completely, disconnect it from the wall outlet. To ensure you can unplug this apparatus quickly if necessary, make sure that the wall outlet and power plug are readily accessible.
 - Store the accessories (batteries, etc.) in a location safely out of the reach of children.
 - Do not drop or strike the product. If the product is damaged, disconnect the power cord and contact a Samsung service centre.
 - To clean this apparatus, unplug the power cord from the wall outlet and wipe the product with a soft, dry cloth. Do not use any chemicals such as wax, benzene, alcohol, thinners, insecticide, aerial fresheners, lubricants, or detergents. These chemicals can damage the appearance of the TV or erase the printing on the product.
 - Do not expose this apparatus to dripping or splashing.
 - Do not dispose of batteries in a fire.
 - Do not short-circuit, disassemble, or overheat the batteries.
 - There is danger of an explosion if you replace the batteries used in the remote with the wrong type of battery. Replace only with the same or equivalent type.
- * The figures and illustrations in this User Manual are provided for reference only and may differ from the actual product appearance. The product design and specifications may change without notice. CIS languages (Russian, Ukrainian, Kazakhs) are not available for this product, since this is manufactured for customers in the EU region.

Contents

	Before Reading This User Manual	2
	Features of your new TV	3
	Warning! Important Safety Instructions	4
01	What's in the Box?	
02	Assembling the TV	
	Attaching the TV to the Stand	10
	Mounting the TV on a wall	11
	Providing proper ventilation for your TV	12
	Safety Precaution: Securing the TV to the wall to prevent falling	13
03	The TV Control Stick	
	Using the TV Controller	15
04	The Remote Control	
	About the Buttons on the Remote Control	16
05	The Samsung Smart Remote	
	About the Buttons on the Samsung Smart Remote	18
	Installing batteries into the Samsung Smart Remote	19
	About the Samsung Smart Remote	19
	Controlling External Devices with a Samsung Remote Control - Using the Universal Remote	21

06	Performing the initial setup	
	Initial setup	22
07	Connections	
	Connecting devices to your TV	23
	Connecting to the Internet	24
08	Selecting Connected Devices	
	Changing the input signal	25
	Editing external devices	25
	Using additional functions	25
09	Troubleshooting and Maintenance	
	Troubleshooting	26
	What is Remote Support?	28
	Eco Sensor and screen brightness	29
	Caring for the TV	29
10	Specifications and Other Information	
	Specifications	30
	Environmental Considerations	30
	Decreasing power consumption	31
	Licences	31
	Warranty Card	33
	WARRANTY CONDITIONS	33

01 What's in the Box?

Make sure the following items are included with your TV. If any items are missing, contact your dealer.

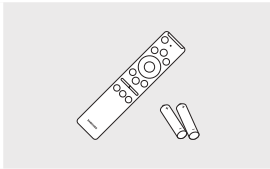

Samsung Smart
Remote & Batteries
(AA x 2)

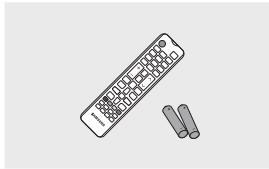

Remote Control &
Batteries
(AAA x 2)

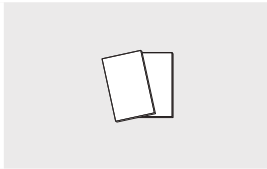

User Manual

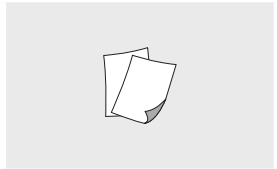

Regulatory Guide

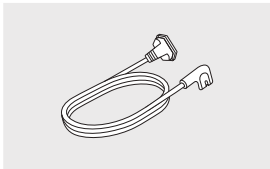

TV Power Cable

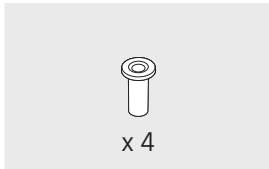

Wall Mount Adapter

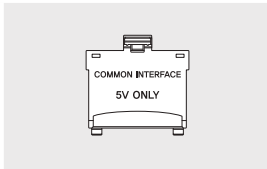

CI Card Adapter

- The items' colours and shapes may vary depending on the models.
- Cables not included can be purchased separately.
- Check for any accessories hidden behind or in the packing materials when opening the box.

An administration fee may be charged in the following situations:

- (a) An engineer is called out at your request, but it is found that the product has no defect (i.e., where the user manual has not been read).
- (b) You bring the unit to a repair centre, but it is found that the product has no defect (i.e., where the user manual has not been read).

You will be informed of the administration fee amount before a technician visits.



Warning: Screens can be damaged from direct pressure when handled incorrectly. We recommend lifting the TV at the edges, as shown.

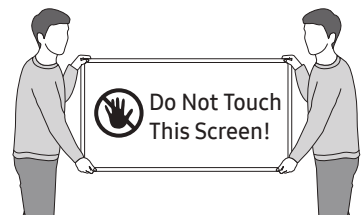

02 Assembling the TV

Attaching the TV to the Stand

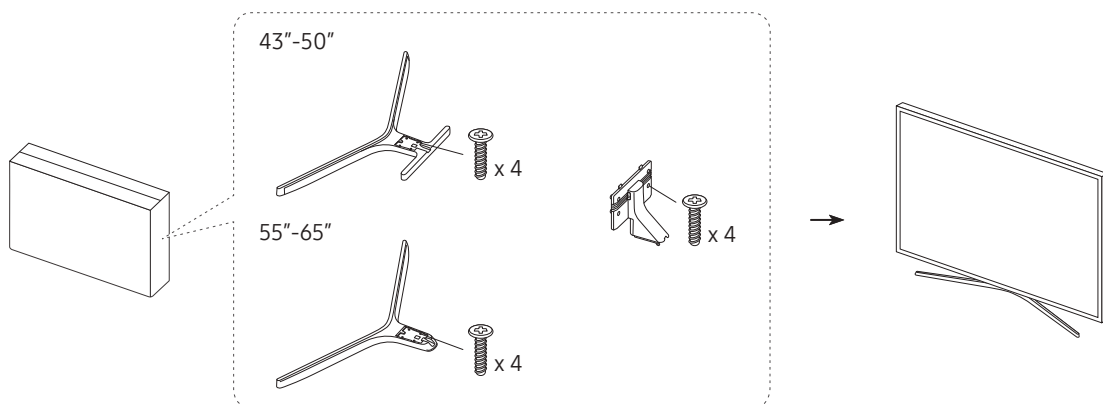

Make sure you have all the accessories shown, and that you assemble the stand following the provided assembly instructions.

Mounting the TV on a wall



If you mount this TV on a wall, follow the instructions exactly as set out by the manufacturer. Unless it is correctly mounted, the TV may slide or fall and cause serious injury to a child or adult and serious damage to the TV.

For models providing wall mount adapters, install them as shown in the figure below before installing the wall mount kit.

- Refer to the installation manual included with the Samsung wall mount kit.

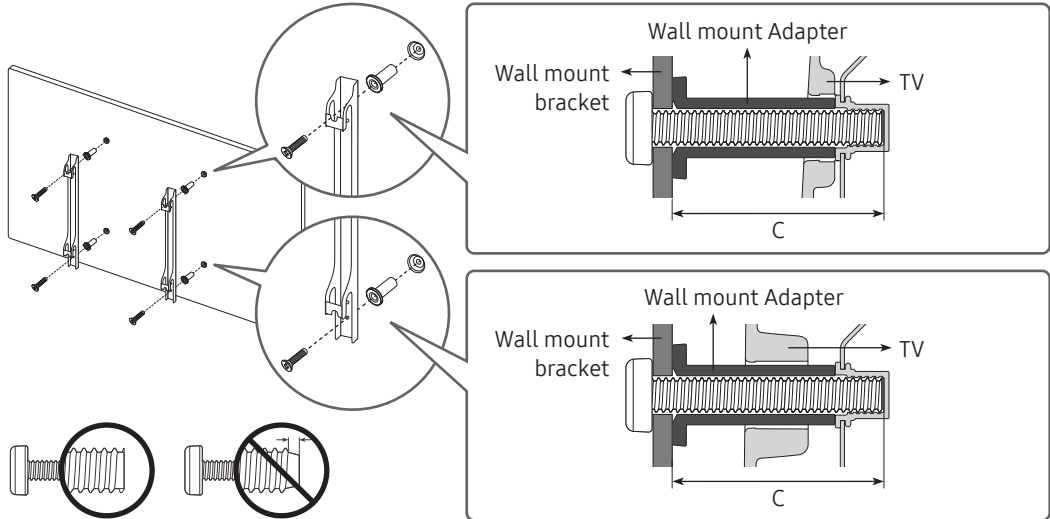

- Samsung Electronics is not responsible for any damage to the product or injury to yourself or others if you choose to install the wall mount on your own.
- You can install your wall mount on a solid wall perpendicular to the floor. Before attaching the wall mount to surfaces other than plaster board, contact your nearest dealer for additional information. If you install the TV on a ceiling or slanted wall, it may fall and result in severe personal injury.
- Standard dimensions for wall mount kits are shown in the table on the next page.
- If you are installing a third-party wall mount, note that the length of the screws you can use to attach the TV to the wall mount is shown in column C in the table on the next page.
- When installing a wall mount kit, we recommend you fasten all four VESA screws.
- If you want to install a wall mount kit that attaches to the wall using two top screws only, be sure to use a Samsung wall mount kit that supports this type of installation. (You may not be able to purchase this type of wall mount kit, depending on the geographical area.)

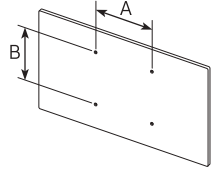
TV size in inches	VESA screw hole specs (A * B) in millimetres	C (mm)	Standard Screw	Quantity	
43-55	200 x 200	43-45	M8	4	
65	400 x 400				



Do not install your wall mount kit while your TV is turned on. This may result in personal injury from electric shock.

- Do not use screws that are longer than the standard dimension or do not comply with the VESA standard screw specifications. Screws that are too long may cause damage to the inside of the TV set.
- For wall mounts that do not comply with the VESA standard screw specifications, the length of the screws may differ depending on the wall mount specifications.
- Do not fasten the screws too firmly. This may damage the product or cause the product to fall, leading to personal injury. Samsung is not liable for these kinds of accidents.
- Samsung is not liable for product damage or personal injury when a non-VESA or non-specified wall mount is used or when the consumer fails to follow the product installation instructions.
- Do not mount the TV at more than a 15 degree tilt.
- Always have two people mount the TV onto a wall.

Providing proper ventilation for your TV

When you install your TV, maintain a distance of at least 10 cm between the TV and other objects (walls, cabinet sides, etc.) to ensure proper ventilation. Failing to maintain proper ventilation may result in a fire or a problem with the product caused by an increase in its internal temperature.

- When you install your TV with a stand or a wall mount, we strongly recommend you use parts provided by Samsung Electronics only. Using parts provided by another manufacturer may cause difficulties with the product or result in injury caused by the product falling.

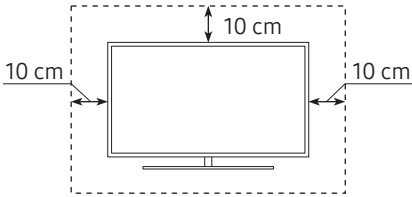
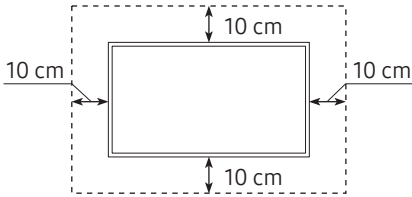
Installation with a stand	Installation with a wall mount
	

Other Cautions

- The actual appearance of the TV may differ from the images in this manual, depending on the model.
- Be careful when you touch the TV. Some parts can be somewhat hot.

Safety Precaution: Securing the TV to the wall to prevent falling



Caution: Pulling, pushing, or climbing on the TV may cause the TV to fall. In particular, ensure your children do not hang on or destabilise the TV. This action may cause the TV to tip over, causing serious injuries or death. Follow all safety precautions provided in the Safety Flyer included with your TV. For added stability and safety, you can purchase and install the anti-fall device as described on the next page.



WARNING: Never place a television set in an unstable location. The television set may fall, causing serious personal injury or death. Many injuries, particularly to children, can be avoided by taking simple precautions such as

- Using cabinets or stands recommended by the manufacturer of the television set.
- Only using furniture that can safely support the television set.
- Ensuring the television set is not overhanging the edge of the supporting furniture.
- Not placing the television set on tall furniture (for example, cupboards or bookcases) without anchoring both the furniture and the television set to a suitable support.
- Not placing the television set on cloth or other materials that may be located between the television set and supporting furniture.
- Educating children about the dangers of climbing on furniture to reach the television set or its controls.

If you are retaining and relocating the television set that you are replacing with this new set, you should apply the same precautions to the old set.

Preventing the TV from falling

1. Using the appropriate screws, firmly fasten a set of brackets to the wall. Confirm that the screws are firmly attached to the wall.
 - You may need additional material such as wall anchors depending on the type of wall.
2. Using the appropriately sized screws, firmly fasten a set of brackets to the TV.
 - For the screw specifications, refer to "Standard Screw" in the table on the previous page.
3. Connect the brackets fixed to the TV and the brackets fixed to the wall with a durable, heavy-duty string, and then tie the string tightly.
 - Install the TV near the wall so that it does not fall backwards.
 - Connect the string so that the brackets fixed to the wall are at the same height as or lower than the brackets fixed to the TV.

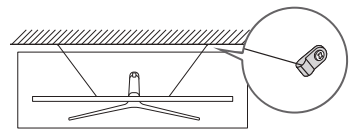
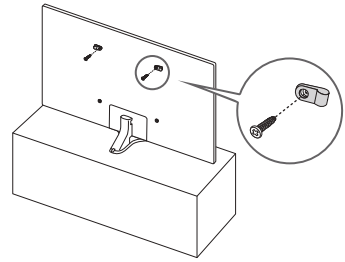

- The product colour and shape may vary depending on the model.

03 The TV Control Stick

Using the TV Controller

You can turn on the TV with the TV Controller button at the bottom of the TV, and then use the Control menu. The Control menu appears when the TV Controller button is pressed while the TV is On. For more information about its usage, refer to the figure below.

- The screen may dim if the protective film on the SAMSUNG logo or the bottom of the TV is not detached. Please remove the protective film.

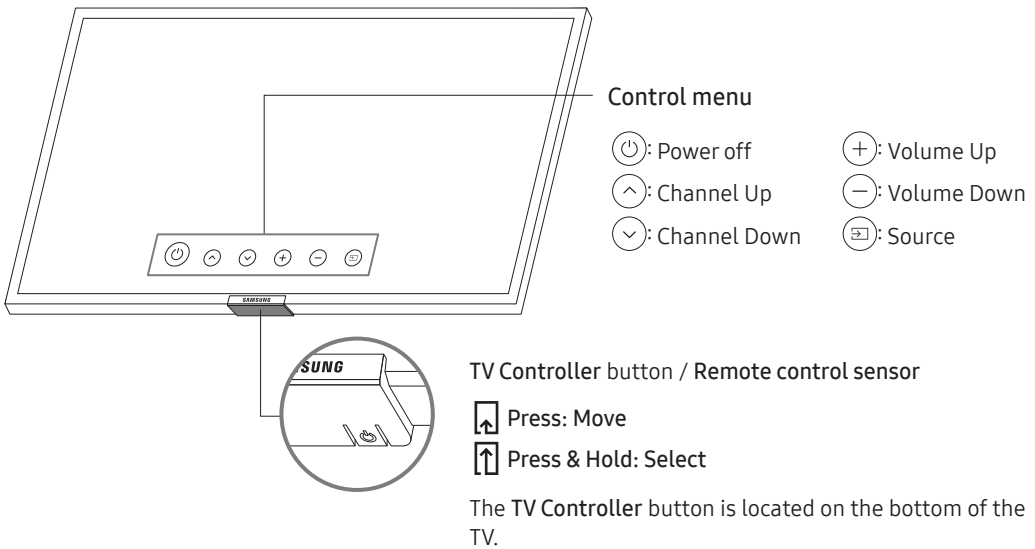

04 The Remote Control

About the Buttons on the Remote Control

- This remote control has Braille points on the **Power**, **Channel**, **Volume**, and **Select** buttons and can be used by visually impaired persons.
- The images, buttons, and functions of the remote control may differ depending on the model.
- If you use the remote control that comes with your TV to control another TV, some functions may not operate normally.

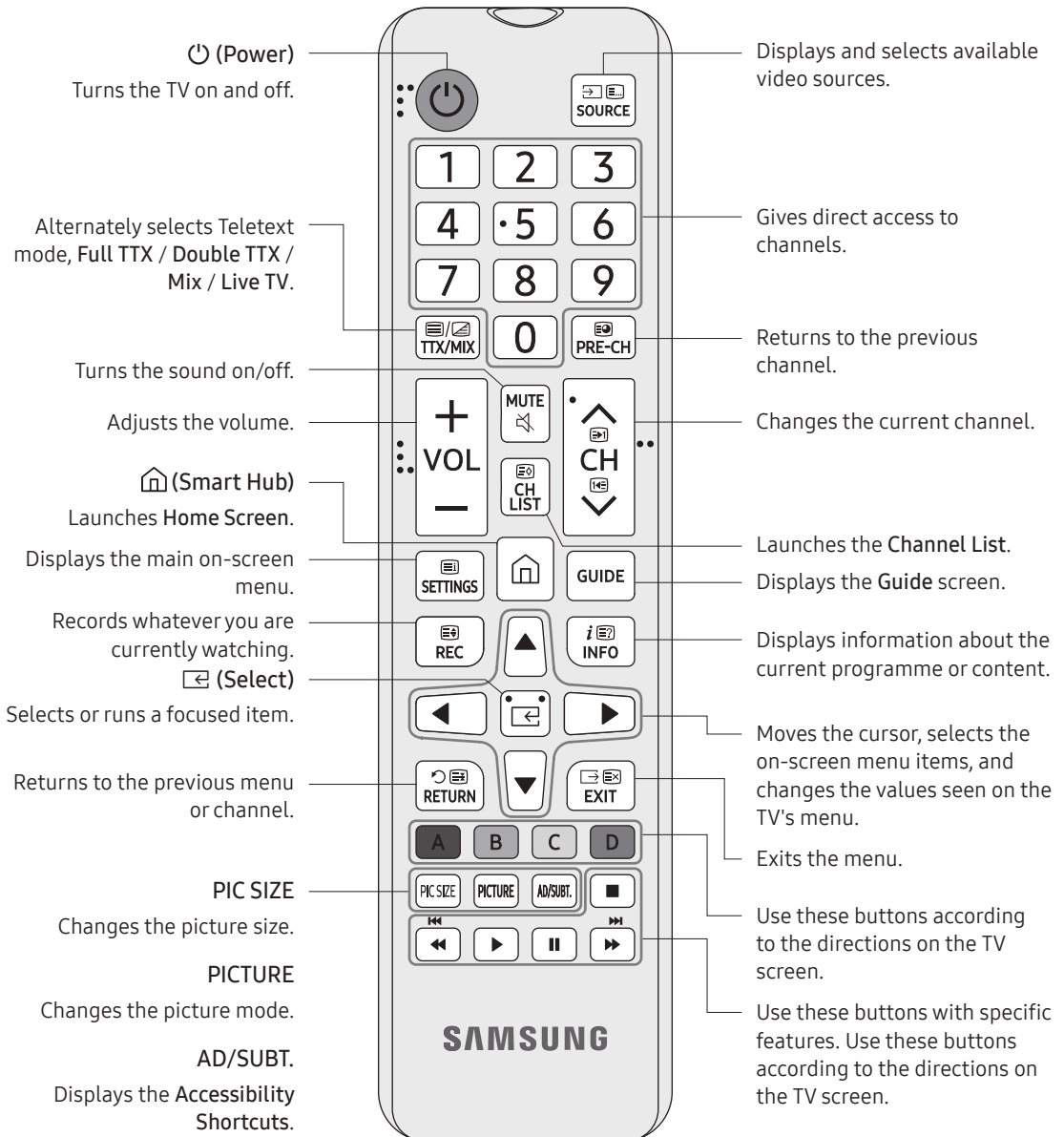

Installing batteries into the remote control (Battery size: AAA)

Match the polarities of the batteries to the symbols on the battery compartment.

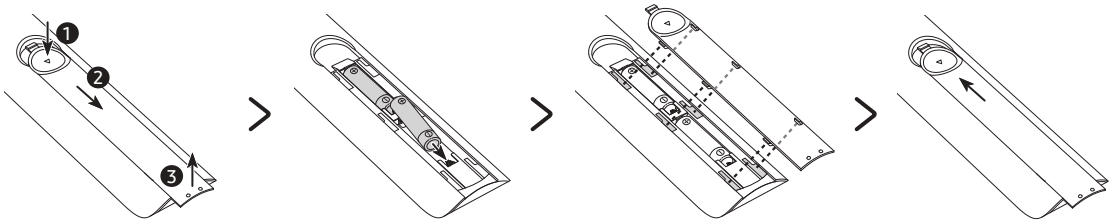

- The colour and shape of the remote may vary depending on the model.
 - Use the remote control within 7 m of the TV.
 - Bright lights may affect the performance of the remote control. Avoid using the remote control near special fluorescent lights or neon signs.
 - Alkaline batteries are recommended for longer battery life.
1. Gently pull on the battery cover's notch and then remove the cover completely once it comes loose.
 2. Insert 2 AAA alkaline batteries, making sure to align the positive and negative polarities correctly.
 3. Place the battery cover on the remote control and insert the cover into the remote control.
 4. Slide the battery cover in the order shown above so that the cover is completely attached to the remote control.

05 The Samsung Smart Remote

About the Buttons on the Samsung Smart Remote

- The images, buttons, and functions of the Samsung Smart Remote may differ depending on the model.
- The Universal Remote function operates normally only when you use the Samsung Smart Remote that comes with the TV.

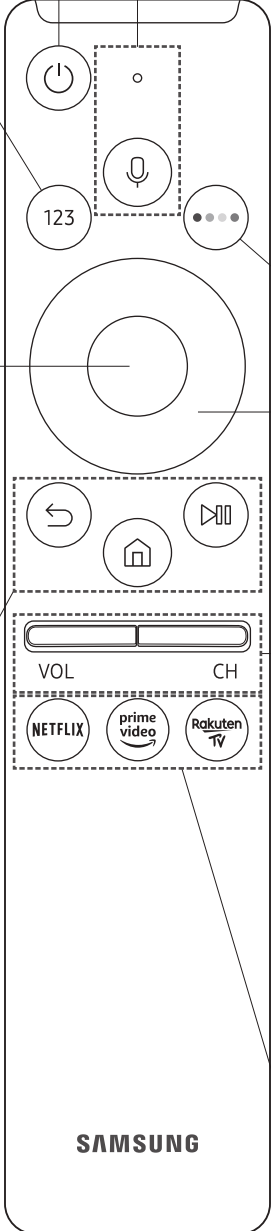

(Power)
Press to turn the TV on or off.

123 (Number button)
When pressed, a number strip appears on the bottom of the screen. Select numbers and then select **Done** to enter a numeric value. Use to change the channel, enter a PIN, enter a ZIP code, etc.

- When pressed for 1 second or more, the TTX menu appears.

(Bixby)
Runs Bixby. Press and hold the button, say a command, and then release the button to run Bixby.

When you press the button, the **Explore Now** menu appears at the bottom of the screen.

- The supported Bixby's languages and features may differ by geographical region.

(Colour button)
Use these coloured buttons to access additional options specific to the feature you are using.

Select
Selects or runs a focused item. When pressed while you are watching a broadcast programme, detailed programme information appears.

(Return)
Returns to the previous menu. When pressed for 1 second or more, the running function is terminated. When pressed while you are watching a programme, the previous channel appears.

(Play/pause)
When pressed, the playback controls appear. Using these controls, you can control the media content that is playing.

(Smart Hub)
Returns to the Home Screen.

Directional pad (up/down/left/right)
Moves the focus and changes the values seen on the TV's menu.

VOL (Volume)
Move the button up or down to adjust the volume. To mute the sound, press the button. When pressed for 1 second or more, the **Accessibility Shortcuts** menu appears.

CH (Channel)
Move the button up or down to change the channel. To see the **Guide** screen, press the button.

- When pressed for 1 second or more, the **Channel List** screen appears.

Press each button to run its function.

Installing batteries into the Samsung Smart Remote

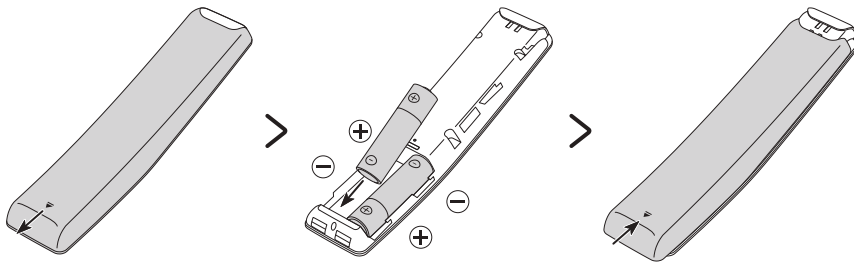

To install the batteries, push the rear cover open in the direction of the arrow at the bottom of the illustration, and then insert the batteries as shown in the figure. Make sure that the positive and negative ends are facing in the correct direction. Close the rear cover as shown.



- Alkaline batteries are recommended for longer battery life.

About the Samsung Smart Remote

When you start the TV for the first time by pressing the **⏻ (Power)** button on the Samsung Smart Remote, the TV automatically pairs with the Samsung Smart Remote. Once the TV and Samsung Smart Remote have paired, you can use the Samsung Smart Remote to operate the TV.

We recommend using Samsung Smart Remote at a distance of less than 6 m. A usable distance may differ depending on the wireless environmental conditions.

Pairing the TV to the Samsung Smart Remote

When you turn on the TV for the first time, the Samsung Smart Remote pairs to the TV automatically. If the Samsung Smart Remote does not pair to the TV automatically, point it at the remote control sensor of the TV, and then press and hold the  and  buttons simultaneously for 3 seconds or more.

- The Samsung Smart Remote can only be paired to one TV at a time.

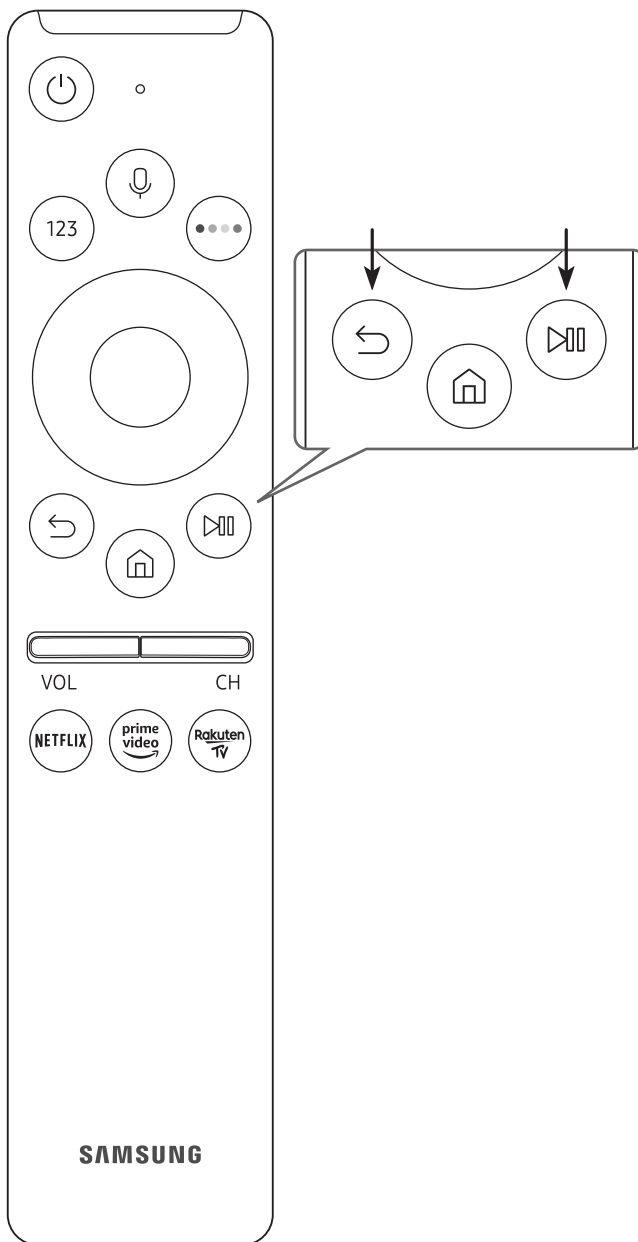

Controlling External Devices with a Samsung Remote Control - Using the Universal Remote



 >  Source > Universal Remote

You can control external devices connected to the TV using a Samsung remote control. To control external devices, register them by following the instructions on the screen.

- This function may not be supported depending on the model.
- You can also use the **Anynet+ (HDMI-CEC)** function to operate external Samsung devices with your TV's remote control without any additional setup.
- Certain external devices connected to the TV may not support the universal remote feature.
- Do not place any obstacles in front of an external device and TV's logo. It may cause signals from the remote control to be transmitted improperly.
- The TV memorises both the external device and its connection port (HDMI 1, HDMI 2, etc.).
- If you have difficulty controlling external devices with the Universal Remote, try adjusting the positions of the external devices.
- This function may not operate properly depending on the TV installation environment and the features of external devices.

06 Performing the initial setup

- The initial setup differs from model to model.
- Turn on the TV using the  button on the remote control or TV controller.
- Noise may occur temporarily when the TV communicates with mobile devices.
- The SmartThings app is available for mobile devices running Android 6.0 or higher or iOS 10 or higher.
- To perform Initial Setup using the SmartThings app, you must connect your mobile device via Wi-Fi.
- If the pop-up for setup does not appear automatically on the SmartThings app on your mobile device, continue setup manually after adding the TV using **Add Device** on the dashboard of the SmartThings app.

You can also start the Initial Setup using the TV's menu ( >  **Settings** > **General** > **Reset**). Follow the instructions displayed on the Initial Setup screen and configure the TV's basic settings to suit your viewing environment.

Initial setup

When you turn on your TV for the first time, it immediately starts the Initial Setup. The Initial Setup allows you to configure the basic settings for the TV to operate, such as broadcast reception, channel search, and network connection, at one time.

- Before starting the Initial Setup, be sure to connect external devices first.
- To use the TV's smart features, the TV must be connected to the Internet.

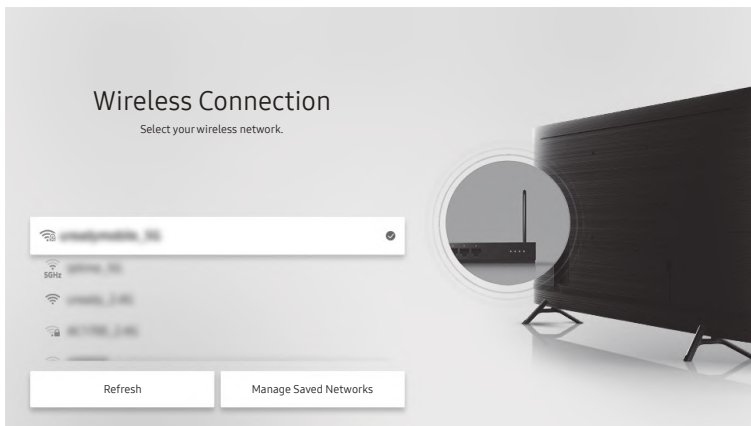

- The image on your TV may differ from the image above depending on the model and geographical area.
- If you connect any external device to HDMI IN (STB) before starting initial setup, the source of your live TV signal is set to **STB**. After finishing with this process, you will not be able to scan all channels and stores them in the TV's memory.
- If you want to connect aerial cable to your TV, select **Aerial**. In this case, you will be able to scan all channels and stores them in the TV's memory.

07 Connections



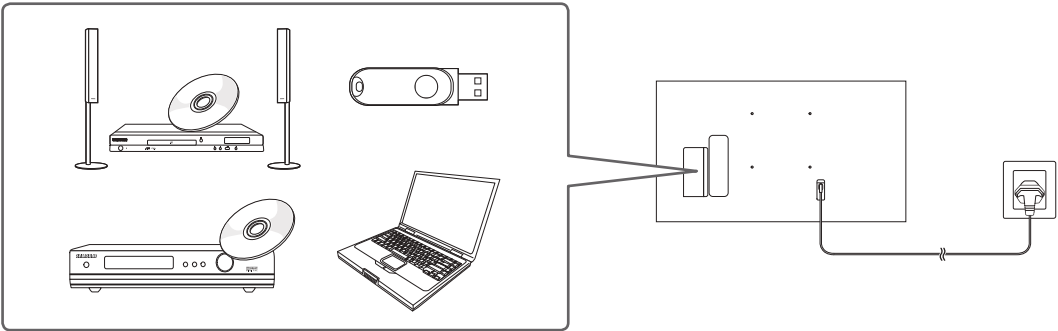



Connecting devices to your TV

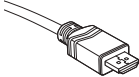

You can connect various external devices using the connectors located at the back of the product. Check the connectors and then refer to the Quick Guide for more instructions on supported external devices.

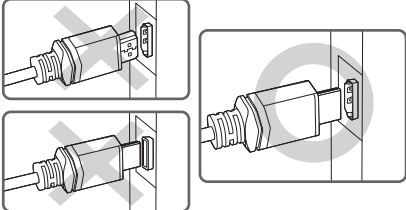
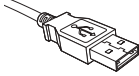
For more information about connections, see the **e-Manual** chapter "**Connections**".

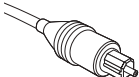
Make sure you have the correct cable before plugging it in. Illustrations of common plugs and ports are shown below.

	Cable Plugs	Ports	
HDMI			 <p>Warning Do not plug cables in upside down. Be sure to check the orientation of the plug before plugging it in.</p>
USB			
Optical			

Connecting to the Internet

Connecting the TV to a network gives you access to online services such as the Smart Hub, as well as software updates.

- For more information about Smart Hub, see the e-Manual chapter, "Smart Features > Using Smart Hub".
- The shape of the rear panel differs among the models.

Network Connection - Wireless

Connect the TV to the Internet using a standard access point or modem.

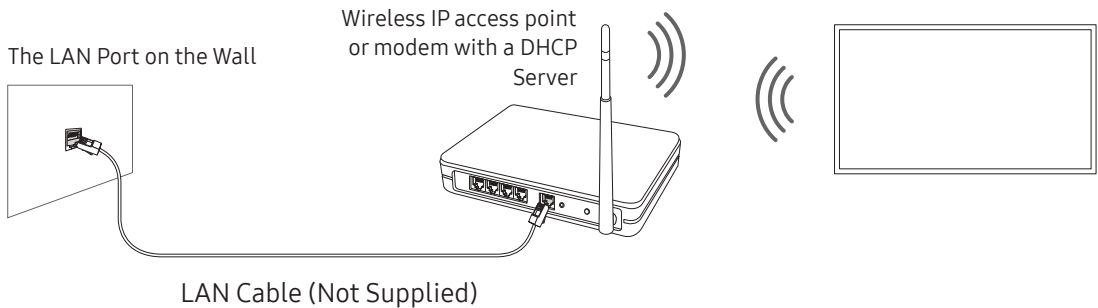

Network Connection - Wired

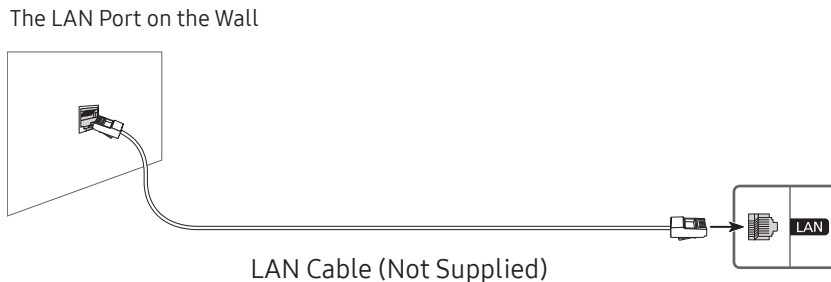

There are three main ways to connect your TV to your network using cable, depending on your network setup. They are illustrated starting below:



- The TV will not be able to connect to the Internet if your network speed is below 10 Mbps.
- Use Cat7 (*STP Type) cable for the connection.
 - * Shielded Twisted Pair

08 Selecting Connected Devices

Changing the input signal

 >  Source

When you select a connected external device on the **Source** screen, the output of the selected device is displayed on the TV's screen.

- For more information about selecting connected devices, see the e-Manual chapter "Switching between external devices connected to the TV".

Editing external devices

You can change the port name for a connected external device or add it to Home Screen.

1. Move the focus to a connected external device.
2. Press the Up directional button. The following functions become available.
 - Available functions may differ depending on the port type.
 - **Universal Remote:** You can control external devices connected to the TV using a Samsung remote control. To control external devices, register them by following the instructions on the screen.
 - **Edit:** You can rename the input ports and change the device icons.
 - **Information:** You can view the detailed information about the external devices connected to the TV.
 - **Add to Home:** You can add the port of an external device to the Home Screen for quick switching.

Using additional functions

You can use the following features on the **Source** screen.

- **Remote Access:** Use the TV to access your PC via remote PC or screen sharing.
- **Connection Guide:** The guide to device connections
- **Universal Remote:** Lets you register external devices to your Samsung remote control and control them using the Remote.

09 Troubleshooting and Maintenance

Troubleshooting

If the TV seems to have a problem, first review this list of possible problems and solutions. Alternatively, review the Troubleshooting Section in the e-Manual. If none of these troubleshooting tips apply, please visit “www.samsung.com” and click on Support, or contact the call centre listed on the back cover of this manual.

- This TFT LED panel is made up of sub pixels which require sophisticated technology to produce. There may be, however, a few bright or dark pixels on the screen. These pixels will have no impact on the performance of the product.
- To keep your TV in optimum condition, upgrade to the latest software. Use the **Update Now** or **Auto update** functions on the TV's menu (🏠 > ⚙️ **Settings** > **Support** > **Software Update** > **Update Now** or **Auto update**).

The TV won't turn on.

- Make sure that the AC power cord is securely plugged in to the TV and the wall outlet.
- Make sure that the wall outlet is working and the power indicator at the bottom of the TV is lit and glowing a solid red.
- Try pressing the **TV Controller** button at the bottom of the TV to make sure that the problem is not with the remote control. If the TV turns on, refer to “The remote control does not work”.

There is no picture/video/sound, or a distorted picture/video/sound from an external device, or “Weak or No Signal” is displayed on the TV, or you cannot find a channel.

- Make sure the connection to the device is correct and that all cables are fully inserted.
- Remove and reconnect all cables connected to the TV and the external devices. Try new cables if possible.
- Confirm that the correct input source has been selected (🏠 > 📺 **Source**).
- Perform a TV self diagnosis to determine if the problem is caused by the TV or the device (🏠 > ⚙️ **Settings** > **Support** > **Self Diagnosis** > **Start Picture Test** or **Start Sound Test**).
- If the test results are normal, reboot the connected devices by unplugging each device's power cord and then plugging it in again. If the issue persists, refer to the connection guide in the user manual of the connected device.
- If you are not using a cable box or satellite box, and your TV is receiving TV signals from an antenna or a cable wall connector, run **Auto Tuning** to search for channels (🏠 > ⚙️ **Settings** > **Broadcasting** > **(Auto Tuning Settings)** > **Auto Tuning**).
 - The **Auto Tuning Settings** may not appear depending on the model or geographical area.
 - If you are using a cable box or satellite box, please refer to the cable box or satellite box manual.

The CI+ does not work.

- Your Samsung TV conforms to the CI+ 1.4 standards.
- Where a CI+ Common Interface module is incompatible with this device, then please remove the module and contact the CI+ operator for assistance.

The remote control does not work.

- Check if the power indicator at the bottom of the TV blinks when you press the remote's Power button. If it does not, replace the remote control's batteries.
- Make sure that the batteries are installed with their poles (+/-) in the correct direction.
- Try pointing the remote directly at the TV from 1.5-1.8 m away.
- If your TV came with a Samsung Smart Remote (Bluetooth Remote), make sure to pair the remote to the TV.

The cable box or satellite box remote control doesn't turn the TV on or off or adjust the volume.

- Programme the cable box or satellite box remote control to operate the TV. Refer to the cable box or satellite box user manual for the SAMSUNG TV code.

The TV settings are lost after 5 minutes.

- The TV is in the **Retail Mode**. Change the **Usage Mode** in the **General Menu** to **Home Mode** (🏠 > ⚙️ Settings > General > System Manager > Usage Mode > Home Mode).



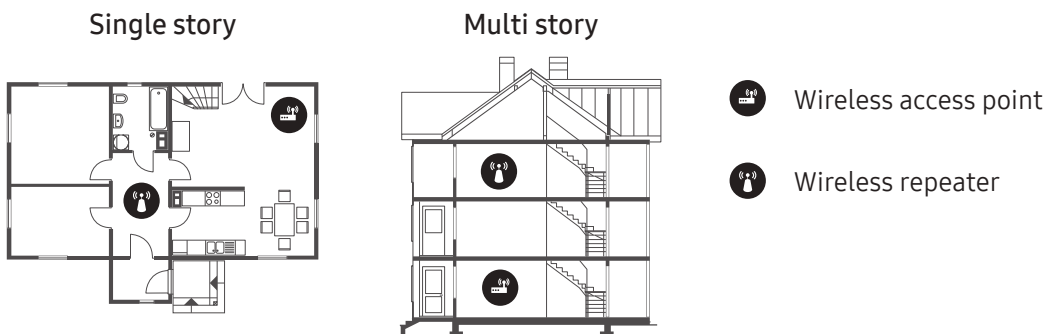

Intermittent Wi-Fi

- Make sure the TV has a network connection (🏠 > ⚙️ Settings > General > Network > Network Status).
- Make sure the Wi-Fi password is entered correctly.
- Check the distance between the TV and the modem or access point. The distance should not exceed 15.2 m.
- Reduce interference by not using or turning off wireless devices. Also, verify that there are no obstacles between the TV and the modem or access point. (The Wi-Fi strength can be decreased by appliances, cordless phones, stone walls/fireplaces, etc.)



- Contact your Internet Service Provider (ISP) and ask them to reset your network circuit to re-register the MAC addresses of your new modem or access point and the TV.

Video Apps problems (Youtube etc)

- Change the DNS to 8.8.8.8. Select  >  **Settings** > **General** > **Network** > **Network Status** > **IP Settings** > **DNS setting** > **Enter manually** > **DNS Server** > enter 8.8.8.8 > **OK**.
- Reset by selecting  >  **Settings** > **Support** > **Self Diagnosis** > **Reset Smart Hub**.



What is Remote Support?

Samsung Remote Support service offers you one-on-one support with a Samsung Technician who can remotely:

- Diagnose your TV
- Adjust the TV settings for you
- Perform a factory reset on your TV
- Install recommended firmware updates



How does Remote Support work?

You can easily get Samsung Remote Support service for your TV:

1. Call the Samsung Contact Centre and ask for remote support.
2. Open the menu on your TV and go to the **Support** section. ( >  **Settings** > **Support**)
3. Select **Remote Management**, then read and agree to the service agreements. When the PIN screen appears, provide the PIN number to the technician.
4. The technician will then access your TV.

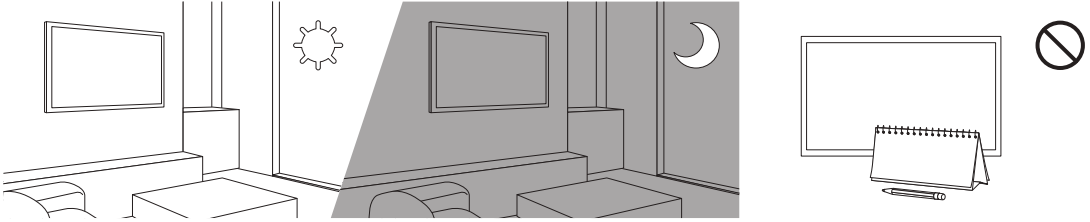
Eco Sensor and screen brightness



Eco Sensor adjusts the brightness of the TV automatically. This feature measures the light in your room and optimises the brightness of the TV automatically to reduce power consumption. If you want to turn this off, go to  >  **Settings** > **General** > **Eco Solution** > **Ambient Light Detection**.

- If the screen is too dark while you are watching TV in a dark environment, it may be due to the **Ambient Light Detection** function.
- The eco sensor is located at the bottom of the TV. Do not block the sensor with any object. This can decrease picture brightness.

Caring for the TV

- If a sticker was attached to the TV screen, some debris can remain after you remove the sticker. Please clean the debris off before watching TV.
- The exterior and screen of the TV can get scratched during cleaning. Be sure to wipe the exterior and screen carefully using a soft cloth to prevent scratches.
- Do not spray water or any liquid directly onto the TV. Any liquid that goes into the product may cause a failure, fire, or electric shock.
- To clean the screen, turn off the TV, then gently wipe away smudges and fingerprints on the panel with a micro-fiber cloth. Clean the body or panel of the TV with a micro-fiber cloth dampened with a small amount of water. After that, remove the moisture with a dry cloth. While cleaning, do not apply strong force to the surface of the panel because it can damage the panel. Never use flammable liquids (benzene, thinner, etc.) or a cleaning agent. For stubborn smudges, spray a small amount of screen cleaner on a micro-fiber cloth, and then use the cloth to wipe away the smudges.

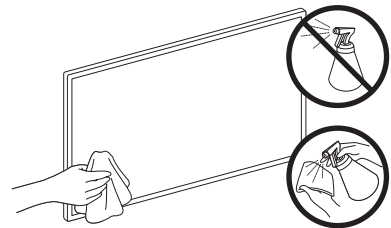

10 Specifications and Other Information

Specifications

Model Name	UE43RU7400 / UE43RU7410	UE50RU7400 / UE50RU7410
Display Resolution	3840 x 2160	3840 x 2160
Screen Size Measured Diagonally	43 inches 108 cm	50 inches 125 cm
Sound (Output)	20 W	20 W
Dimensions (W x H x D) Body With stand	970.2 x 563.2 x 58.1 mm 970.2 x 648.0 x 343.7 mm	1124.8 x 650.2 x 59.0 mm 1124.8 x 735.8 x 346.7 mm
Weight Without Stand With Stand	9.5 kg 12.1 kg	13.8 kg 16.5 kg
Model Name	UE55RU7400	UE65RU7400
Display Resolution	3840 x 2160	3840 x 2160
Screen Size Measured Diagonally	55 inches 138 cm	65 inches 163 cm
Sound (Output)	20 W	20 W
Dimensions (W x H x D) Body With stand	1238.6 x 714.2 x 58.6 mm 1238.6 x 800.0 x 360.6 mm	1457.5 x 837.3 x 59.0 mm 1457.5 x 922.8 x 387.3 mm
Weight Without Stand With Stand	17.2 kg 19.7 kg	25.1 kg 28.0 kg

Environmental Considerations

Operating Temperature	10°C to 40°C (50°F to 104°F)
Operating Humidity	10% to 80%, non-condensing
Storage Temperature	-20°C to 45°C (-4°F to 113°F)
Storage Humidity	5% to 95%, non-condensing

- The design and specifications are subject to change without prior notice.
- For information about the power supply, and more information about power consumption, refer to the label-rating attached to the product.
- Typical power consumption is measured according to IEC 62087.
- You can see the label-rating attached to the back of the TV. (For some models, you can see the label-rating inside the cover terminal.)

Decreasing power consumption

When you shut the TV off, it enters Standby mode. In Standby mode, it continues to draw a small amount of power. To decrease power consumption, unplug the power cord when you don't intend to use the TV for a long time.

Licences



The terms HDMI and HDMI High-Definition Multimedia Interface, and the HDMI Logo are trademarks or registered trademarks of HDMI Licensing LLC in the United States and other countries.

Recommendation - EU Only



Hereby, Samsung Electronics, declares that this equipment is in compliance with Directive 2014/53/EU.

The full text of the EU declaration of conformity is available at the following internet address: <http://www.samsung.com> go to Support > Search Product Support and enter the model name.

This equipment may be operated in all EU countries.

BT max transmitter power : 100mW at 2.4GHz – 2.4835GHz

Wi-Fi max transmitter power : 100mW at 2.4GHz–2.4835GHz

For information on Samsung's environmental commitments and product-specific regulatory obligations, e.g. REACH, WEEE, Batteries, visit http://www.samsung.com/uk/aboutsamsung/samsungelectronics/corporatecitizenship/data_corner.html

WARNING - TO PREVENT THE SPREAD OF FIRE, KEEP CANDLES OR OTHER ITEMS WITH OPEN FLAMES AWAY FROM THIS PRODUCT AT ALL TIMES.



Warranty Card



United Kingdom



Republic of Ireland (EIRE)

This Samsung product is warranted for a period of twelve (12) months from the original date of purchase, against defective materials and workmanship. In the event that warranty service is required, you should return the product to the retailer from whom it was purchased. However, Samsung Authorised Dealers and Authorised Service Centres in other EC Countries will comply with the warranty on the terms issued to purchasers in the country concerned. In case of difficulty, details of our Authorised Service Centres are available from:

Samsung Electronics U.K. Ltd
Samsung Customer Support Centre
Selectapost 38, Sheffield, S97 3FJ
United Kingdom

United Kingdom
Tel : 0330 SAMSUNG (7267864)
www.samsung.com/uk/support

EIRE
Tel : 0818 717100
www.samsung.com/ie/support

WARRANTY CONDITIONS

1. The warranty is only valid if, when warranty service is required, the warranty card is fully and properly completed and is presented with the original invoice or sales slip or confirmation, and the serial number on the product has not been defaced.
2. Samsung's obligations are limited to the repair or, at its discretion, replacement of the product or the defective part.
3. Warranty repairs must be carried out by Authorised Samsung Dealers or Authorised Service Centres. No re-imbursment will be made for repairs carried out by non-Samsung Dealers and, any such repair work and damage to the products caused by such repair work will not be covered by this warranty.
4. This product is not considered to be defective in materials nor workmanship by reason that it requires adaptation in order to conform to national or local technical or safety standards in force in any Country other than the one for which the product was originally designed and manufactured.
This warranty will not cover, and no re-imbursment will be made for such adaptation nor any damage which may result.
5. This warranty covers none of the following:
 - a) Periodic check-ups, maintenance and repair or replacement of parts due to normal wear and tear.
 - b) Cost relating to transport, removal or installation of the product.
 - c) Misuse, including the failure to use this product for its normal purposes or incorrect installation.
 - d) Use of this product in a commercial/ business environment, which shall include, but is not limited to, the following: any use for profit or financial gain, public display or events such as clubs, bars and restaurants including continuous statistical or graphical display, or any commercial use of continuous or intentional long term display of News reels ("tickers"), static or fixed images such as timetables and 4:3 pictures or video content displaying permanent black bars.
 - e) Damage caused by Lightning, Water, Fire, Acts of God, War, Public Disturbances, incorrect mains voltage, improper ventilation or any other cause beyond the control of Samsung.
 - f) Spillage of food or liquid or use of any other hazardous substances, which may affect the product.
 - g) Performance due to differences in broadcasting method between countries.
6. This warranty is valid for any person who legally acquired possession of the product during the warranty period.
7. The consumers' statutory rights in any applicable national legislation whether against the retailer arising from the purchase contract or otherwise are not affected by this warranty. Unless there is national legislation to the contrary, the rights under this warranty are the consumers' sole rights and Samsung, its subsidiaries and distributors shall not be liable for indirect or consequential loss or any damage to disc based media, removable memory or any other related equipment or material.
8. Some products may differ from these guidelines. Please check with your dealer or the local Samsung web-site.

This page is intentionally
left blank.

This page is intentionally
left blank.

SAMSUNG



Contact SAMSUNG WORLD WIDE

If you have any questions or comments relating to Samsung products, please contact the SAMSUNG customer care centre.

Country	Customer Care Centre ☎	Web Site
IRELAND (EIRE)	0818 717100	www.samsung.com/ie/support
UK	0330 SAMSUNG (7267864)	www.samsung.com/uk/support