

Acer LCD Monitor

User Guide

Copyright © 2016. Acer Incorporated.
All Rights Reserved.

Acer LCD Monitor User Guide
Original Issue: 3/2016

Changes may be made periodically to the information in this publication without obligation to notify any person of such revisions or changes. Such changes will be incorporated in new editions of this manual or supplementary documents and publications. This company makes no representations or warranties, either expressed or implied, with respect to the contents hereof and specifically disclaims the implied warranties of merchantability or fitness for a particular purpose.

Record the model number, serial number, purchase date and place of purchase information in the space provided below. The serial number and model number are recorded on the label affixed to your computer. All correspondence concerning your unit should include the serial number, model number and purchase information.

No part of this publication may be reproduced, stored in a retrieval system, or transmitted, in any form or by any means, electronically, mechanically, by photocopy, recording or otherwise, without the prior written permission of Acer Incorporated.

Acer LCD Monitor User Guide

Model number: _____

Serial number: _____

Date of purchase: _____

Place of purchase: _____

Acer and the Acer logo are registered trademarks of Acer Incorporated. Other companies' product names or trademarks are used herein for identification purposes only and belong to their respective companies.

Information for your safety and comfort

Safety instructions

Read these instructions carefully. Keep this document for future reference. Follow all warnings and instructions marked on the product.

Special notes on LCD monitors

The following are normal with the LCD monitor and do not indicate a problem.

- Due to the nature of the fluorescent light, the screen may flicker during initial use. Turn off the power switch and then turn it on again to make sure the flicker disappears.
- You may find slightly uneven brightness on the screen depending on the desktop pattern you use.
- The LCD screen has 99.99% or more effective pixels. It may include blemishes of 0.01% or less such as a missing pixel or pixel lit all the time.
- Due to the nature of the LCD screen, an afterimage of the previous screen may remain after switching the image, when the same image is displayed for hours. In this case, the screen is recovered slowly by changing the image or turning off the power switch for a few hours.

Cleaning your monitor

Please carefully follow these guidelines when cleaning the monitor:

- Always unplug the monitor before cleaning.
- Use a soft cloth to wipe the screen and cabinet front and sides.

Accessibility

Be sure that the power outlet you plug the power cord into is easily accessible and located as close to the equipment operator as possible. When you need to disconnect power from the equipment, be sure to unplug the power cord from the electrical outlet.

Safe listening

To protect your hearing, follow these instructions.

- Gradually increase the volume until you can hear it clearly and comfortably and without distortion.
- After setting the volume level, do not increase it after your ears have adjusted.
- Limit the amount of time listening to music at high volume.
- Avoid turning up the volume to block out noisy surroundings.
- Turn the volume down if you can't hear people speaking near you.

Warnings

- Do not use this product near water.
- Do not place this product on an unstable cart, stand or table. If the product falls, it could be seriously damaged.
- Slots and openings are provided for ventilation to ensure reliable operation of the product and to protect it from overheating. These openings must not be blocked or covered. The openings should never be blocked by placing the product on a bed, sofa, rug or other similar surface. This product should never be placed near or over a radiator or heat register, or in a built-in installation unless proper ventilation is provided.
- Never push objects of any kind into this product through cabinet slots as they may touch dangerous voltage points or short-out parts that could result in a fire or electric shock. Never spill liquid of any kind onto or into the product.
- To avoid damage of internal components and to prevent battery leakage, do not place the product on a vibrating surface.
- Never use it under sporting, exercising, or any vibrating environment which will probably cause unexpected short current or damage internal devices.
- The adapter is only used for this monitor, do not be used for other purposes.
- Your device uses one of the following power supplies:
Manufacture: SHENZHEN HONOR ELECTRONIC CO., LTD.: ADS-65AL-19-3 19065G (65W)
DELTA ELECTRONICS, INC.: ADP-65JH HB (65W)

Using electrical power

- This product should be operated from the type of power indicated on the marking label. If you are not sure of the type of power available, consult your dealer or local

power company.

- Do not allow anything to rest on the power cord. Do not locate this product where people will walk on the cord.
- If an extension cord is used with this product, make sure that the total ampere rating of the equipment plugged into the extension cord does not exceed the extension cord ampere rating. Also, make sure that the total rating of all products plugged into the wall outlet does not exceed the fuse rating.
- Do not overload a power outlet, strip or receptacle by plugging in too many devices. The overall system load must not exceed 80% of the branch circuit rating. If power strips are used, the load should not exceed 80% of the power strip's input rating.
- This product's power cord is equipped with a three-wire grounded plug. The plug only fits in a grounded power outlet. Make sure the power outlet is properly grounded before inserting the power cord plug. Do not insert the plug into a non-grounded power outlet. Contact your electrician for details.



.....
Warning! The grounding pin is a safety feature. Using a power outlet that is not properly grounded may result in electric shock and/or injury.



.....
Note: The grounding pin also provides good protection from unexpected noise produced by other nearby electrical devices that may interfere with the performance of this product.

- Use the product only with the supplied power supply cord set. If you need to replace the power cord set, make sure that the new power cord meets the following requirements: detachable type, UL listed/CSA certified, type SPT-2, rated 7 A 125 V minimum, VDE approved or its equivalent, 4.6 meters (15 feet) maximum length.

Product servicing

Do not attempt to service this product yourself, as opening or removing covers may expose you to dangerous voltage points or other risks. Refer all servicing to qualified service personnel.

Unplug this product from the wall outlet and refer servicing to qualified service personnel when:

- the power cord or plug is damaged, cut or frayed
- liquid was spilled into the product
- the product was exposed to rain or water
- the product has been dropped or the case has been damaged
- the product exhibits a distinct change in performance, indicating a need for service
- the product does not operate normally after following the operating instructions



Note: Adjust only those controls that are covered by the operating instructions, since improper adjustment of other controls may result in damage and will often require extensive work by a qualified technician to restore the product to normal condition.

Potentially explosive environments

Switch off your device in any area with a potentially explosive atmosphere and obey all signs and instructions. Potentially explosive atmospheres include areas where you would normally be advised to turn off your vehicle engine. Sparks in such areas could cause an explosion or fire resulting in bodily injury or even death. Switch off the device near gas pumps at service stations. Observe restrictions on the use of radio equipment in fuel depots, storage and distribution areas; chemical plants; or where blasting operations are in progress. Areas with a potentially explosive atmosphere are often, but not always, marked. They include below deck on boats, chemical transfer or storage facilities, vehicles using liquefied petroleum gas (such as propane or butane), and areas where the air contains chemicals or particles such as grain, dust or metal powders.

Additional safety information

Your device and its enhancements may contain small parts. Keep them out of the reach of small children.

IT Equipment Recycling Information

Acer is strongly committed to environmental protection and views recycling, in the form of salvaging and disposal of used equipment, as one of the company's top priorities in minimizing the burden placed on the environment.

We at Acer are very conscious of the environmental effects of our business and strive to identify and provide the best working procedures to reduce the environmental impact of our products.

For more information and help when recycling, please go to this website:

<http://www.acer-group.com/public/Sustainability/sustainability01.htm>

Visit www.acer-group.com for further information on the features and benefits of our other products.

Disposal instructions



Do not throw this electronic device into the trash when discarding. To minimize pollution and ensure utmost protection of the global environment, please recycle.

For more information on the Waste from Electrical and Electronics Equipment (WEEE) regulations, visit <http://www.acer-group.com/public/Sustainability/sustainability01.htm>

LCD pixel statement

The LCD unit is produced with high-precision manufacturing techniques. Nevertheless, some pixels may occasionally misfire or appear as black or red dots. This has no effect on the recorded image and does not constitute a malfunction.

This product has been shipped enabled for power management:

- Activate display's Sleep mode within 5 minutes of user inactivity.
- Wake the monitor when it is in Active Off mode, move the mouse or press any keyboard key.

Tips and information for comfortable use

Computer users may complain of eyestrain and headaches after prolonged use. Users are also at risk of physical injury after long hours of working in front of a computer. Long work periods, bad posture, poor work habits, stress, inadequate working conditions, personal health and other factors greatly increase the risk of physical injury.

Incorrect computer usage may lead to carpal tunnel syndrome, tendonitis, tenosynovitis or other musculoskeletal disorders. The following symptoms may appear in the hands, wrists, arms, shoulders, neck or back:

- numbness, or a burning or tingling sensation
- aching, soreness or tenderness
- pain, swelling or throbbing
- stiffness or tightness
- coldness or weakness

If you have these symptoms, or any other recurring or persistent discomfort and/or pain related to computer use, consult a physician immediately and inform your company's health and safety department.

The following section provides tips for more comfortable computer use.

Finding your comfort zone

Find your comfort zone by adjusting the viewing angle of the monitor, using a footrest, or raising your sitting height to achieve maximum comfort. Observe the following tips:

- refrain from staying too long in one fixed posture
- avoid slouching forward and/or leaning backward
- stand up and walk around regularly to remove the strain on your leg muscles

Taking care of your vision

Long viewing hours, wearing incorrect glasses or contact lenses, glare, excessive room lighting, poorly focused screens, very small typefaces and low-contrast displays could stress your eyes. The following sections provide suggestions on how to reduce eyestrain.

Eyes

- Rest your eyes frequently.
- Give your eyes regular breaks by looking away from the monitor and focusing on a distant point.
- Blink frequently to keep your eyes from drying out.

Display

- Keep your display clean.
- Keep your head at a higher level than the top edge of the display so your eyes point downward when looking at the middle of the display.
- Adjust the display brightness and/or contrast to a comfortable level for enhanced text readability and graphics clarity.
- Eliminate glare and reflections by:
 - placing your display in such a way that the side faces the window or any light source
 - minimizing room light by using drapes, shades or blinds
 - using a task light
 - changing the display's viewing angle
 - using a glare-reduction filter
 - using a display visor, such as a piece of cardboard extended from the display's top front edge
- Avoid adjusting your display to an awkward viewing angle.
- Avoid looking at bright light sources, such as open windows, for extended periods of time.

Developing good work habits

Develop the following work habits to make your computer use more relaxing and productive:

- Take short breaks regularly and often.
- Perform some stretching exercises.
- Breathe fresh air as often as possible.
- Exercise regularly and maintain a healthy body.



Declaration of Conformity

We,

Acer Incorporated

8F, 88, Sec. 1, Xintai 5th Rd., Xizhi, New Taipei City 221, Taiwan

Contact Person: Mr. RU Jan, e-mail: ru.jan@acer.com

And,

Acer Italy s.r.l

Via Lepetit, 40, 20020 Lainate (MI) Italy

Tel: +39-02-939-921 ,Fax: +39-02 9399-2913

www.acer.it

Declare under our own responsibility that the product:

Product: LCD Monitor
Trade Name: Acer
Model Number: H277HK
SKU Number: H277HK xxxxxx;
(“x” = 0~9, a~z, A~Z, or blank)

To which this declaration refers conforms to the relevant standard or other standardizing documents:

- EN55022:2010 Class B; EN55024:2010
- EN 61000-3-2:2006+A1:2009+A2:2009, Class D
- EN61000-3-3:2008
- EN60950-1:2006/A11:2009/A1:2010+A12:2011
- Regulation (EC) No. 1275/ 2008; EN 50564:2011; IEC 62301:2011
- EN50581:2012

We hereby declare above product is in compliance with the essential requirements and other relevant provisions of EMC Directive 2004/108/EC, Low Voltage Directive 2006/95/EC, and RoHS Directive 2011/65/EU and Directive 2009/125/EC with regard to establishing a framework for the setting of ecodesign requirements for energy-related product.

Year to begin affixing CE marking 2016.

RU Jan / Sr. Manager
Regulation, Acer Inc.

February 29, 2016

Date



Acer America Corporation
 333 West San Carlos St., San Jose
 Suite 1500
 CA 95110, U. S. A.
 Tel : 254-298-4000
 Fax : 254-298-4147
 www.acer.com



Federal Communications Commission Declaration of Conformity

This device complies with Part 15 of the FCC Rules. Operation is subject to the following two conditions: (1) this device may not cause harmful interference, and (2) this device must accept any interference received, including interference that may cause undesired operation.

The following local Manufacturer /Importer is responsible for this declaration:

Product:	LCD Monitor
Model Number:	H277HK
SKU Number:	H277HK xxxxxx ("x" = 0~9, a~z, or A~Z)
Name of Responsible Party:	Acer America Corporation
Address of Responsible Party:	333 West San Carlos St. Suite 1500 San Jose, CA 95110 U. S. A.
Contact Person:	Acer Representative
Phone No.:	254-298-4000
Fax No.:	254-298-4147

Contents

Information for your safety and comfort	iii
Safety instructions	iii
Special notes on LCD monitors	iii
Cleaning your monitor	iii
Accessibility	iv
Safe listening	iv
Warnings	iv
Using electrical power	iv
Product servicing	v
Potentially explosive environments	vi
Additional safety information	vi
IT Equipment Recycling Information	vi
Disposal instructions	vi
LCD pixel statement	vii
Tips and information for comfortable use	vii
Finding your comfort zone	vii
Taking care of your vision	viii
Developing good work habits	viii
Declaration of Conformity	ix
Federal Communications Commission Declaration of Conformity	x
Unpacking	1
Attaching the base (for selected models)	2
Screen position adjustment	3
Connecting the adapter and AC Power cord	3
Power saving	3
Display Data Channel (DDC)	4
Connector pin assignment	4
24-pin color display signal cable	4
19-pin color display signal cable	5
20-pin color display signal cable	5
Standard timing table	6
Installation	8
Users controls	9
Panel controls	9
Using the Shortcut Menu	9
Input source Selection	9
Acer eColor Management	10
Operation instructions	10
Features and benefits	10
Using the OSD Menus	11
Picture Menu	11
OSD Menu	12

Setting Menu	13
Information Menu	14
Troubleshooting	15
DVI/HDMI/DP/Mini DP Mode (Optional)	15

Unpacking

Please check that the following items are present when you unpack the box, and save the packing materials in case you need to ship or transport the monitor in the future.

LCD monitor

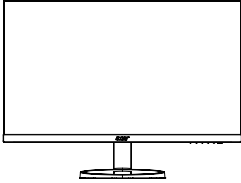

Quick start guide

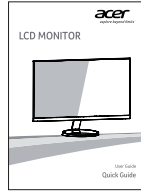

Audio cable
(Optional)

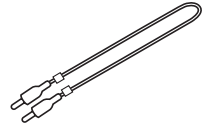

DP Cable
(Optional)

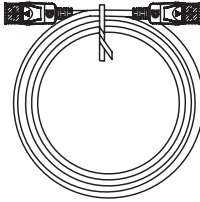

HDMI cable
(Optional)

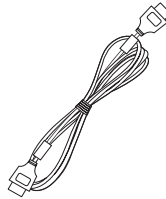

AC Power cord

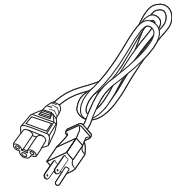

DVI/DVI(Dual Link) Cable

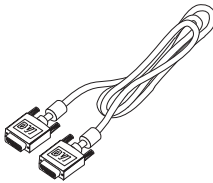

AC Adapter

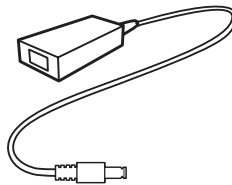

Mini DP cable (Optional)

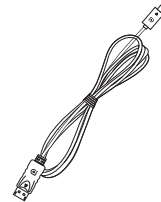

Attaching the base (for selected models)



.....

Note: Remove the monitor and monitor base from its packaging. Carefully place the monitor face-down on a stable surface -- use a cloth to avoid scratching the screen.

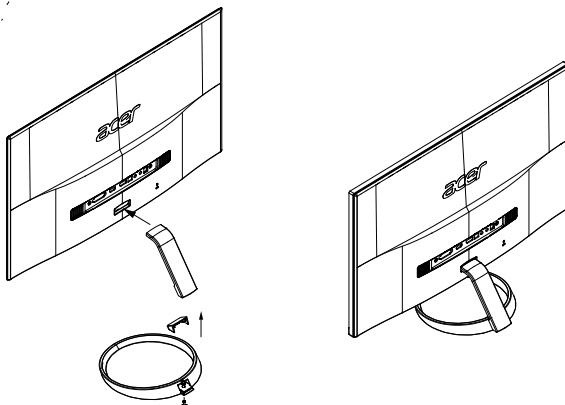

- 1 Attach the monitor stand arm to the base.
- 2 Ensure that the base is locked onto the monitor stand arm.
 - Secure the base to the monitor stand arm by turning the white screw using the integrated tab or a suitable coin. (for selected models)



.....

Note: Take care when performing the installation to avoid injuring yourself.

Screen position adjustment

To optimize the viewing position, you can adjust the monitor tilt, using both of your hands to hold the edges of the monitor. The monitor can be adjusted to 15 degrees up or 5 degrees down.

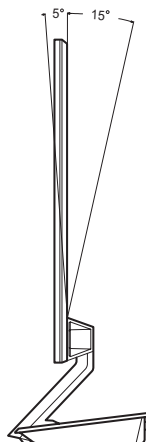

Connecting the adapter and AC Power cord

- Check first to make sure that the power cord you use is the correct type required for your area.
- The monitor has a universal power supply that allows operation in either 100/120 V AC or 220/240 V AC voltage area. No user-adjustment is required.
- Plug one end of the AC power cord to the Adapter, and plug the other end into an AC outlet.
- For units using 120 V AC:
Use a UL-listed cord set, type SVT wire and plug rated 10 A/125 V.
- For units using 220/240 V AC:
Use a cord set consisting of H05VV-F cord and plug rated 10 A/250 V. The cord set should have the appropriate safety approvals for the country in which the equipment will be installed.

Power saving

The monitor will be switched to "power saving" mode by the control signal from the display controller, as indicated by the blinking blue light.

Mode	LED light
On	Blue
Standby/Power saving	Blinking Blue

The power saving mode will be kept until a control signal has been detected or the keyboard or mouse is activated. The recovery time from "power saving" mode back to "on" is around 3 seconds.

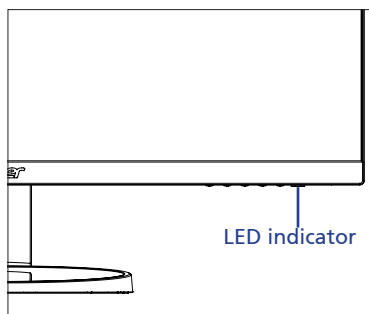

Display Data Channel (DDC)

To make installation easier, so long as your system supports the DDC protocol, the monitor is able to plug-and-play. The DDC is a communication protocol through which the monitor automatically informs the host system about its capabilities; for example, supported resolutions and corresponding timing. The monitor supports the DDC2B standard.

24-pin color display signal cable

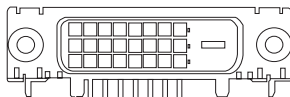

PIN No.	Description	PIN No.	Description
1	TMDS data 2-	13	TMDS data 3+
2	TMDS data 2+	14	+5 V power
3	TMDS data 2/4 shield	15	DVI detect
4	TMDS data 4-	16	Hot-plug detection
5	TMDS data 4+	17	TMDS data 0-
6	DDC clock	18	TMDS data 0+
7	DDC data	19	TMDS data 0/5 shield
8	NC	20	TMDS data 5-
9	TMDS data 1-	21	TMDS data 5+
10	TMDS data 1+	22	TMDS clock shield
11	TMDS data 1/3 shield	23	TMDS clock+
12	TMDS data 3-	24	DDC TMDS clock-

19-pin color display signal cable

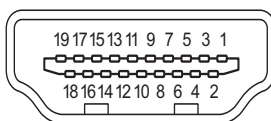

PIN No.	Description	PIN No.	Description
1	TMDS Data2+	2	TMDS Data2 Shield
3	TMDS Data2-	4	TMDS Data1+
5	TMDS Data1 Shield	6	TMDS Data1-
7	TMDS Data0+	8	TMDS Data0 Shield
9	TMDS Data0-	10	TMDS Clock+
11	TMDS Clock Shield	12	TMDS Clock-
13	CEC	14	Reserved (N.C. on device)
15	SCL	16	SDA
17	DDC/CEC Ground	18	+5V Power
19	Hot Plug Detect		

20-pin color display signal cable

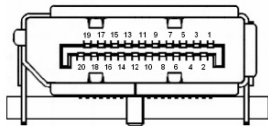

PIN No.	Description	PIN No.	Description
1	ML_Lane 0+	2	GND
3	ML_Lane 0-	4	ML_Lane 1+
5	GND	6	ML_Lane 1-
7	ML_Lane 2+	8	GND
9	ML_Lane 2-	10	ML_Lane 3+
11	GND	12	ML_Lane 3-
13	CONFIG1	14	CONFIG2
15	AUX CH+	16	GND
17	AUX CH-	18	Hot Plug
19	Return	20	DP_PWR

Mini 20-pin color display signal cable

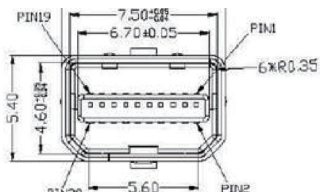

PIN No.	Description	PIN No.	Description
1	GND	2	Hot Plug
3	ML_Lane 3 (n)	4	CONFIG1
5	ML_Lane 3 (p)	6	CONFIG2
7	GND	8	GND
9	ML_Lane 2 (n)	10	ML_Lane 0 (n)
11	ML_Lane 2 (p)	12	ML_Lane 0 (p)
13	GND	14	GND
15	ML_Lane 1 (n)	16	AUX CH (p)
17	ML_Lane 1 (p)	18	AUX CH (n)
19	GND	20	DP_PWR

Standard timing table

No.	Mode	Resolution	Refresh Rate
1	VGA	640x480	60Hz
2		640x480	72Hz
3		640x480	75Hz
4	MAC	640x480	66.66Hz
5	VESA	720x400	70Hz
6	SVGA	800x600	56Hz
7		800x600	60Hz
8		800x600	72 Hz
9		800x600	75 Hz
10	MAC	832x624	74.55 Hz
11	XGA	1024x768	60 Hz
12		1024x768	70 Hz
13		1024x768	75 Hz
14	MAC	1152x870	75 Hz
15	VESA	1152x864	75 Hz
16		1280x960	60 Hz
17	SXGA	1280x1024	60 Hz
18		1280x1024	75 Hz
19	VESA	1280x720	60 Hz
20	WXGA	1280x800	60 Hz
21		1360x768	60 Hz
22	WXGA+	1440x900	60 Hz
23		1440x900	75 Hz
24	WSXGA+	1680x1050	60 Hz
25		1680x1050	75 Hz
26	UXGA	1600x1200	60 Hz
27	FHD	1920x1080	60 Hz
28	QWXGA	2048x1152	60 Hz
29	QHD	2560x1440	60 Hz
30	UHD	3840x2160	29.97 Hz
31		3840x2160	30 Hz
32		3840x2160	25 Hz
33		3840x2160	23.98 Hz
34		3840x2160	24 Hz
35*		3840x2160	60 Hz

*DisplayPort and HDMI 2.0 only

Installation

To install the monitor on your host system, please follow the steps below:
Steps

- 1 Connect the video cable
 - a Make sure both the monitor and computer are switched off.
 - b Connect the digital cable
 - (1) DVI Cable (Optional, only Dual-Input Model)
 - a. Make sure both the monitor and computer are powered-OFF.
 - b. Connect the DVI (Dual Link) cable to the computer.
 - (2) HDMI Cable (Optional, only HDMI-Input Model)
 - a. Make sure both the monitor and computer are powered-OFF.
 - b. Connect the HDMI cable to the computer.
 - (3) DP Cable (Optional, only DP-Input Model)
 - a. Make sure both the monitor and computer are powered-OFF.
 - b. Connect the DP cable to the computer.
 - (4) Mini DP cable (Optional, only Mini DP-Input model)
 - a. Make sure both the monitor and computer are powered-OFF
 - b. connect the Mini DP cable to the computer
 - c Connect the audio cable (Optional, only Audio-input Model).
- 2 Connect the adapter
 - a Connect the AC cord to the adapter.
 - b Connect one end of the adapter to the monitor and the other end to a properly grounded, AC outlet.
- 3 Turn on the monitor and computer
Turn on the monitor first, then the computer. This sequence is very important.
- 4 If the monitor does not function properly, please refer to the troubleshooting section to diagnose the problem.

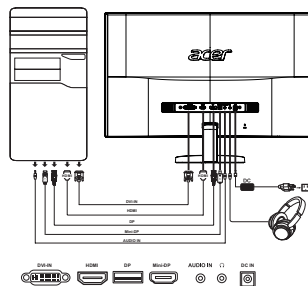

Note: Audio output is only for audio output model.

In order to prevent damage to the monitor, do not lift the monitor by its base.

Users controls

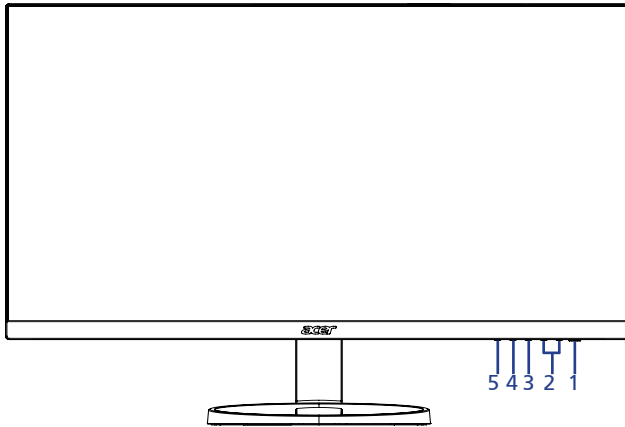

Panel controls

No.	Item	Description
1	Power button/ indicator	Turn the monitor on/off. Blue indicates power on. Blinking blue indicates standby/ power saving mode.
2	< / > button	Press the < / > button to navigate to the desired function, and press the Menu button to select the function. Press the < / > button to change the settings of the current function.
3	Menu/Enter button	Press to view the OSD menu. Press it again to enter a selection in the OSD menu.
4	Auto/Exit button	<ul style="list-style-type: none"> When the OSD menu is active, press this button to exit the OSD menu. When the OSD menu is inactive, press this button for two seconds to activate the Auto Adjustment function and the monitor will automatically optimize the display position, focus, and clock of your display. (For VGA mode only)
5	Empowering Key	Press this button to open the Acer eColor Management OSD and access the scenario modes.

FreeSync:

It can allow a FreeSync supported graphics source to dynamically adjust display refresh rate based on typical content frame rates for power efficient, virtually stutter free and low-latency display update.

Using the Shortcut Menu



Press any of the function buttons (Empowering Key, **Auto** button, or **Menu** button) to open the shortcut menu. The shortcut menu lets you quickly select the most commonly accessed settings.

Icon	Item	Description
	Empowering	Press the Empowering Key to open the Acer eColor Management and access the scenario modes.
	Auto	Press the Auto button to activate the Auto Adjustment function and the monitor will automatically optimize the display position, focus, and clock of your display. (For VGA mode only)
	Menu	Press the Menu button to activate the OSD menu.
	Volume	Press the Volume button to adjust volume. (Optional, only Audio-Input Model)
	Input	Press the Input button to select from different video sources that may be connected to your monitor. (Optional, only Dual-Input Model or HDMI-Input Model) When Auto Source is off, press the "Input" Hot key to display the input source Menu. User can switch input source, or to control the "Auto Source" function.

Input Source Selection

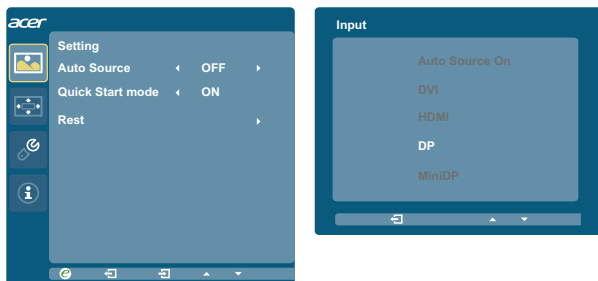

1. The default of Auto Source is "On", it can support auto search for signal source in order.
2. When Auto Source is Off, press the "Input" Hot key to display the input source Menu. User can switch input source, or to control the "Auto Source" function.

Acer eColor Management

Operation instructions

- 1 Press the Empowering Key to open the Acer eColor Management OSD menu and access the scenario modes.



- 2 Press the </> button to select the desired mode.
- 3 Press the **Auto** button to confirm the selection and exit Acer eColor Management.

Features and benefits

Icon	Mode type	Description
	User mode	User-defined. Settings can be fine-tuned to suit any situation.
	ECO mode	Adjusts the settings to reduce power consumption.
	Standard mode	Default settings. Reflects native display capability.
	Graphic mode	Enhances colors and emphasizes fine detail. Pictures and photographs appear in vibrant colors with sharp detail.
	Movie mode	Displays scenes in clearest detail. Presents great visuals, even in unsuitably-lit environments.

Using the OSD Menus



Note: The following content is for general reference only. Actual product specifications may vary.

Your LCD monitor is equipped with an on-screen display (OSD) menu for making various adjustments and settings.

Press the **Menu** button to open the OSD menu. You can use the OSD menu to adjust the picture quality, OSD timeout, and general settings.

Picture Menu

The Picture menu is used for adjusting the picture quality.

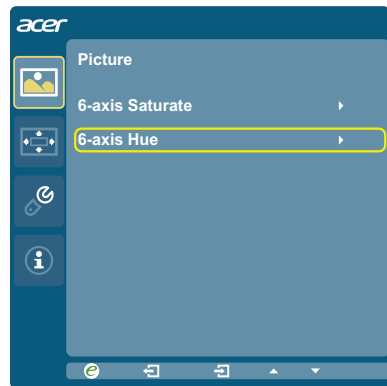
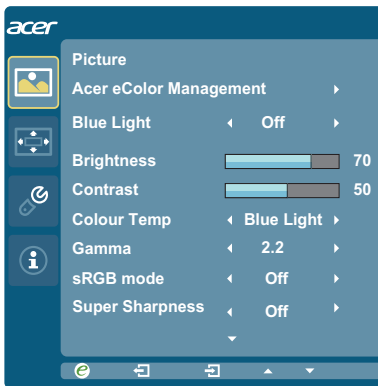

- 1 Press the **Menu** button to bring up the OSD menu.
- 2 Press the **</>** button to select  **Picture** and press the **Menu** button to enter the **Picture** menu.
The following options are available in the **Picture** menu: Acer ecolor Management, Blue Light, Brightness, Contrast, 6-axis Saturate, 6-axis Hue, sRGB mode, Super sharpness, and Colour Temp.
- 3 Press the **</>** button to scroll through the **Picture** options, and press the **Menu** button to enter its sub-menu.
- 4 Press the **</>** button to adjust/select the setting and press the **Auto** button to confirm.
- 5 Blue Light: filter out blue light by adjusting different Blue Light showing ratio - 80%, 70%, 60%, 50%.



Note: Higher values allow more blue light through. For the best protection select a lower value.

6 Brightness: Adjust the brightness from 0 to 100.



.....
Note: Adjusts the balance between light and dark shades.

7 Contrast: Adjust the contrast from 0 to 100.



.....
Note: Sets the degree of difference between light and dark areas.

8 Colour Temp is for user to adjust the colour temperature from blue light, warm, cool and user. The default value is warm.

9 Gamma mode is for user to adjust Tone of Liminance. The default value is 2.2 (Standard value for Windows)

10 sRGB mode is for user such as DSCs, printers, photographer to get better color matching representation with the peripheral device.

11 Super Sharpness technology can simulate high-resolution images by boosting the pixel density of the original source. It can make the image more sharper and clear.

12 6-axis Saturate: Adjust saturation of red, green, blue, yellow, magenta and cyan
6-axis Hue: Adjust hue for red, green, blue, yellow, magenta and cyan.

OSD Menu

The OSD menu is used for adjusting the OSD menu location and the timeout setting.

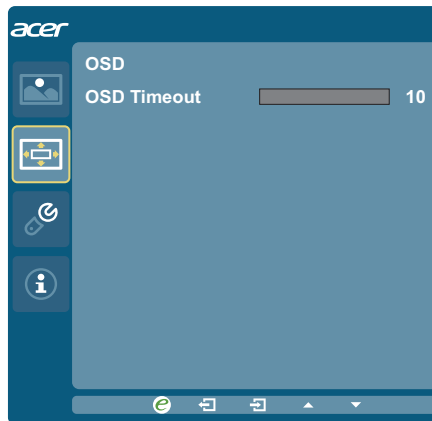

1 Press the **Menu** button to bring up the OSD menu.

2 Press the **</>** button to select  **OSD** and press the **Menu** button to enter the **OSD** menu.

3 Press the **</>** button to adjust the OSD Timeout (10 ~ 120 seconds), the default is 10 seconds.

Setting Menu

The Setting menu is used for adjusting the general settings for current input signal such as aspect ratio, OSD language, and etc.

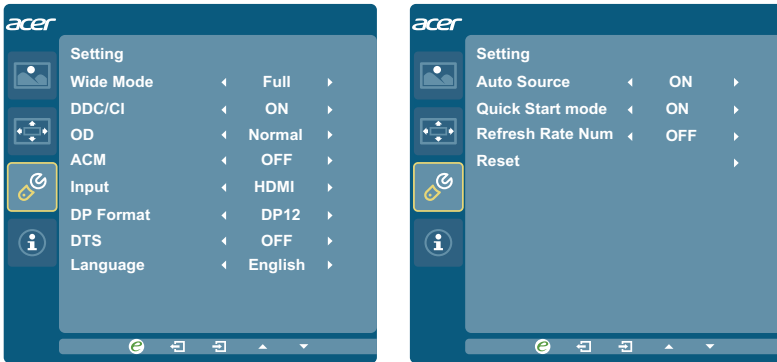

- 1 Press the **Menu** button to bring up the OSD menu.
- 2 Press the **< / >** button to select  **Setting** and press the **Menu** button to enter the **Setting** menu.
The following options are available in the Setting menu: Wide Mode, DDC/CI, OD, ACM, Input, DP Format, DTS, Language, Auto Source, Quick Start mode, and Reset.
- 3 Press the **< / >** button to scroll through the **Setting** options, and press the **Menu** button to enter its sub-menu.
- 4 Press the **< / >** button to adjust/select the setting and press the **Auto** button to confirm.
- 5 Wide mode: You can select which screen aspect you are using. The options are Full, Aspect, and 1:1.
- 6 DDC/CI: Allows the monitor settings to be set through the software on the PC.



Note: DDC/CI, short for Display Data Channel/Command Interface, which allows monitor controls to be sent via software.

- 7 OD: Select Off, Normal, or Extreme.
- 8 ACM: Turn ACM on or off. The default is off.
- 9 Input: Select the source from DVI, HDMI, DP, or miniDP.
- 10 DP Format :Default is DP1.2, can selection DP support DP1.1 or DP1.2 format.
- 11 DTS: Turn DTS Sound On or Off. Your monitor is equipped with two 3W speakers on the rear. DTS Sound is stratified and creates a remarkable sonic flow.
- 12 Language: Set the OSD menu language.
- 13 Auto Source:The default is "On", can support auto search for signal source in order.
- 14 Quick start mode: Select Off or On. The default is "Off". Turn on to speed up boot speed.
- 15 Refresh rate num: Display the panel's current refresh rate on the screen. The default value is "Off".

Information Menu

The Information menu displays the basic information of the LCD monitor.



- 1 Press the **Menu** button to bring up the OSD menu.
- 2 To view the basic information of the LCD monitor, press the **</>** button to select  **Information**.

Troubleshooting

Before sending your LCD monitor for servicing, please check the troubleshooting list below to see if you can self-diagnose the problem.

DVI/HDMI/DP Mode (Optional)

Problem	LED status	Remedy
No picture visible	Blue	Using the OSD menu, adjust brightness and contrast to maximum or reset to their default settings.
	Off	Check the power switch. Check if the AC power cord is properly connected to the monitor.
	Blinking Blue	Check if the video signal cable is properly connected at the back of monitor. Check if the computer system is switched on and in power saving/standby mode.



For DTS patents, see <http://patents.dts.com>. Manufactured under license from DTS Licensing Limited. DTS, the Symbol, & DTS and the Symbol together are registered trademarks, and DTS Sound is a trademark of DTS, Inc. © DTS, Inc. All Rights Reserved.