

electric*i*Ⓞ

USER MANUAL



ULTRA HD SMART LED TV

eiQ-43UHDT2SMH-V2

LED TV

CONTENTS

SAFETY INFORMATION	3
CONNECTION AND PREPARATION OF TV	6
WHAT IS INCLUDED	6
INSTALLATION OF LEGS	6
WALL MOUNTING	7
BUTTONS	8
INPUT / OUTPUT TERMINALS	9
CONNECTING TO EXTERNAL DEVICES	10
REMOTE CONTROL	11
INSTALLATION OF BATTERIES	12
INITIAL SETUP	12
BASIC OPERATION	13
SETTING OF STANDBY MODE	13
SETTING THE INPUT SOURCE	13
TV MENU	14
PICTURE SETUP	14
SOUND SETUP	15
CHANNEL SETUP	16
SETTINGS	17
TIME	18
LOCK	18
LAUNCHER	19
TV	19
APP	19
MEDIA	20
TECHNICAL SPECIFICATION	21
SUPPORTED SIGNAL MODES	22
SIMPLE TROUBLESHOOTING	23
MANUFACTURER SUPPORT	24

SAFETY INFORMATION

- Read these instructions – All the safety and operating instructions should be read before this product is operated.
- Keep these instructions – The safety and operating instructions should be retained for future reference.
- Heed all warnings – All warnings on the appliance and in the operating instructions should be adhered to.
- Follow all instructions – All operating and usage instructions should be followed.
- Do not use this equipment near water – The appliance should not be used near water or moisture e.g. in a wet basement or near a swimming pool.
- Clean only with a dry cloth. Do not use solvents or petroleum based fluids.
- Do not block any ventilation openings.
- Do not install near any heat sources such as radiators, stoves or other apparatus (including amplifiers) that produce heat.
- Do not tamper with the supplied plug. This plug is a BS1363 standard plug.
- Protect the power cord from being walked on or pinched, particularly at the plug and at the point where they exit from the appliance.
- Only use attachments/accessories specified by the manufacturer.
- Unplug the apparatus during lightning storms or when unused for long periods of time.
- Refer all servicing to qualified personnel. Servicing is required when the apparatus has been damaged in any way, such as power supply cord or plug is damaged, liquid has been spilled or objects have fallen into the apparatus or it has been exposed to rain or moisture, it does not operate normally or has been dropped.
- Please keep the unit in a well ventilated environment.
- The TV should only be connected to an earthed mains power supply with AC 100-240V~ 50/60Hz
- To prevent overload, do not share the same power supply socket with too many other electronic components.
- Do not place any connecting wires where they may be stepped on or tripped over.
- Do not place heavy items on the cable as this may cause damage.
- Hold the main plug, not the wires, when removing from a socket.
- Unplug immediately and seek professional help if the plug or cable is damaged, liquid has spilt onto the set, if accidentally exposed to water or moisture, if anything accidentally penetrates the ventilation slots or if the set does not work normally.
- Do not remove the safety covers. There are no user serviceable parts inside.
- To avoid battery leakage, remove exhausted batteries from the remote control when not in use for a long period.
- Do not block ventilation slots on the back cover. The TV can be placed in a

cabinet but ensure there is at least 5cm (2") clearance all around.

- Do not tap or shake the TV screen, this may damage internal components.
- At full volume, prolonged listening may damage the users hearing.
- Diagrams within the manual are for illustrative purposes only, and as such there may be differences to the actual product received.

WARNING

Never place a television set in an unstable location. A television set may fall, causing serious personal injury or death. Many injuries, particularly to children, can be avoided by taking simple precautions such as:

- Use cabinets or stands recommended by the manufacturer of the television.
- Only use furniture that can safely support the television set.
- Ensure the television is not overhanging the edge of the supporting furniture.
- Do not place the television on tall furniture (for example, cupboards or bookcases) without anchoring both the furniture and the television to a suitable support.
- Do not place the television set on cloth or other materials that may be located between the television set and the supporting furniture.
- Educate children about the dangers of climbing on furniture to reach the television or its controls.

If your existing television set is being retained and relocated, the same considerations as above should be applied.

WARNING

To reduce the risk of fire or electric shock, do not expose this apparatus to rain or moisture. The apparatus shall not be exposed to dripping or splashing and objects filled with liquids, such as vases, shall not be placed on or next to the apparatus.

WARNING

The wall plug socket is used as a disconnection device and should remain readily accessible.

CAUTION

Danger of explosion if the battery is incorrectly replaced.
Replace only with the same or equivalent type.
Batteries shall not be exposed to excessive heat such as direct sunlight, fire or the like. Used batteries should be recycled appropriately.

CAUTION

To reduce the risk of electric shock, **DO NOT** remove the cover (or back).
No user serviceable parts inside. Refer servicing to qualified service personnel.

ATTENTION

- Place the TV on a firm and flat surface, leaving a space of at least 10cm around the set and 30cm from the top of the set to the ceiling or cabinet. Ensure the TV is positioned close to the wall to avoid it falling when pushed.

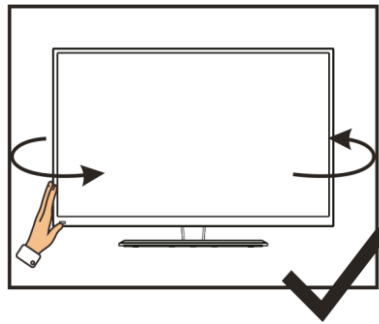
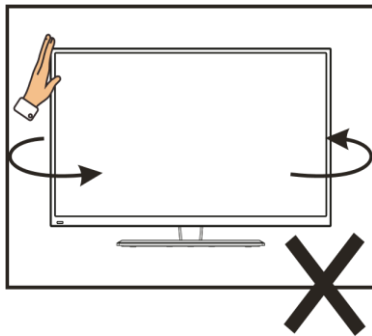
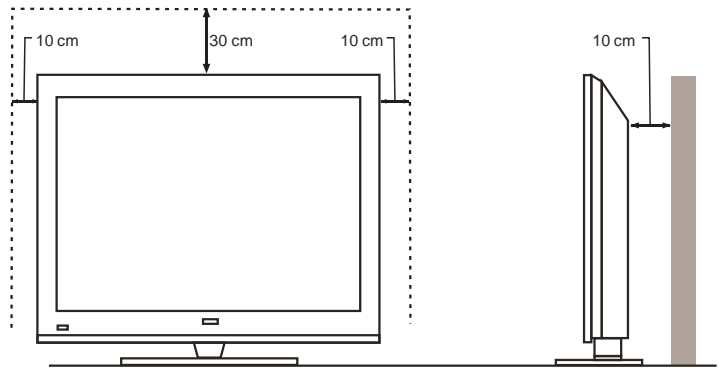

- When twisting the TV set, do not hold the top of the TV, you should twist from the base.

- When lifting the TV, do not use one hand to handle it, you should lift the TV using two hands, ensuring pressure is not put on the screen itself.

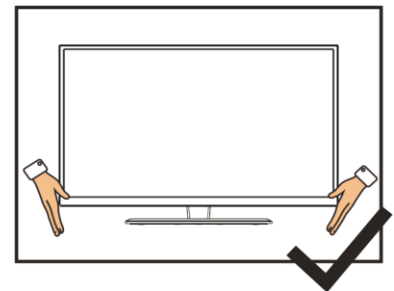
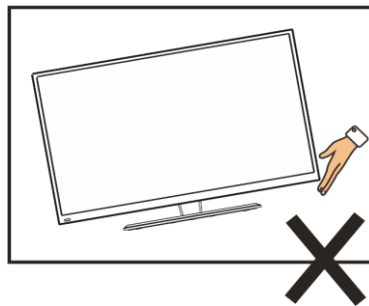

CONNECTION AND PREPARATION OF THE TV

WHAT IS INCLUDED



TV Set



Remote Control
(2 x AAA Batteries)



User Manual

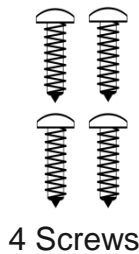

4 Screws

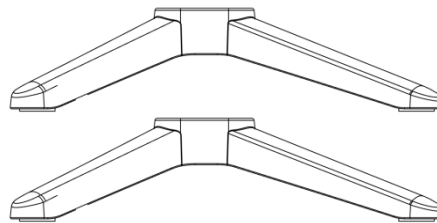

2 Legs

INSTALLATION OF LEGS

- 1 Place the TV with the front facing downwards on a soft cloth pads on a desk.
- 2 Insert the legs into the sockets on the base of the TV.
- 3 Insert the screws into the sockets and tighten them with a screwdriver. Do not use an electric screwdriver, or similar.

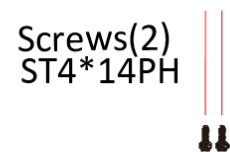
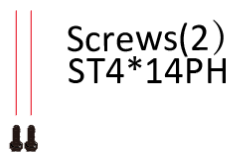
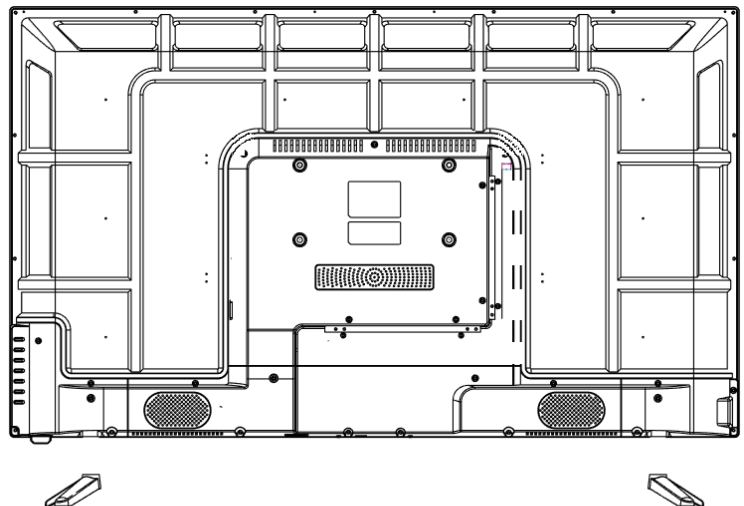

WALL MOUNTING

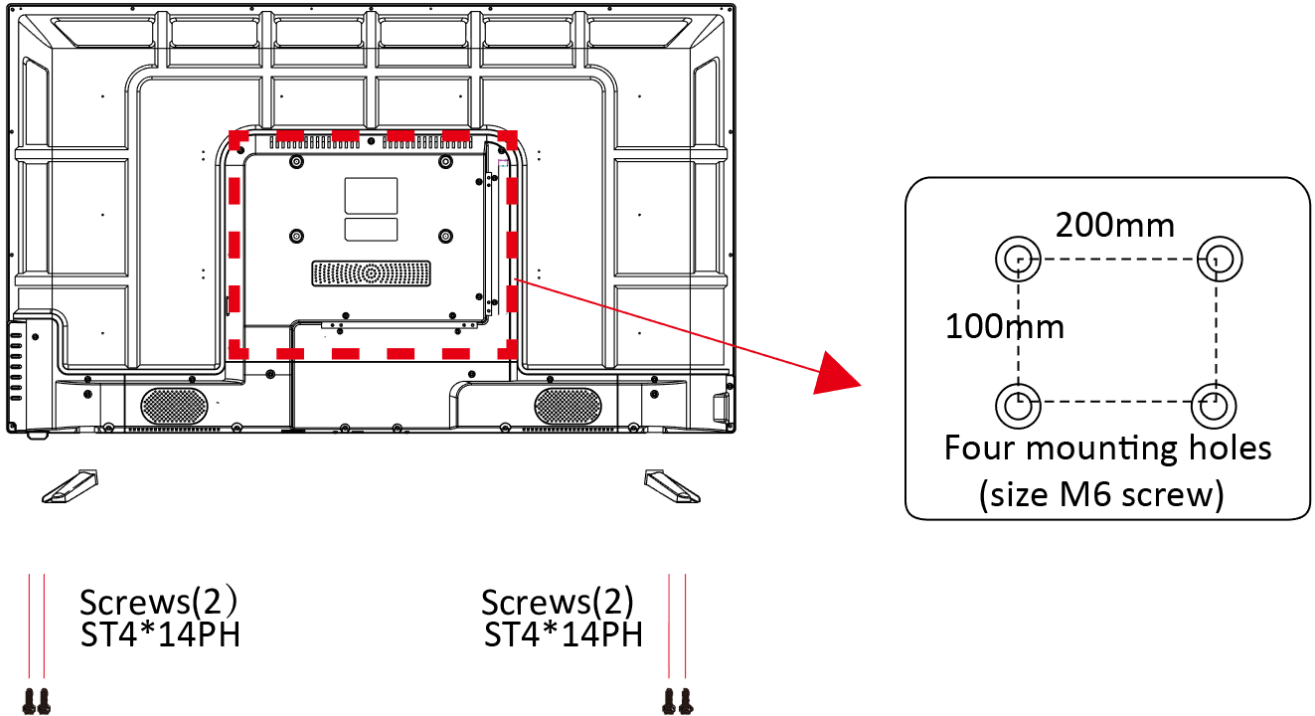

- The TV is provided with mounting holes for a VESA approved wall mounting bracket (not supplied).
- The VESA mounting pattern is :
200x100mm and the size of the bolts for the top holes is 4 x M6 x 12(not supplied).
- Do not use bolts longer than the size specified above for your model or damage will occur to the internal components.

NOTES:

- Do not install this product until this manual has been read and understood thoroughly. Please keep these instructions for future reference.
- Due to the heavy weight and dimensions of the LCD screens and their fragile nature, we recommend that they are unpacked and assembled by 2 people and professional installers are used to wall mount them (Wall mounting is optional). If you do not understand the instructions, or are unsure how to install this product, please contact a professional for assembly advice and assistance.
- Careful consideration should be made regarding the location the television is to be wall mounted as some walls are not suitable for installation. If the television is to be mounted on drywall, the mount must be anchored into a wooden stud, concrete block or brick behind the drywall. Installing on drywall alone will not support the weight of the display.
- When drilling holes it is particularly important to take care of electrical cables, water or gas pipes in the wall. Please follow the instructions provided by the wall bracket manufacturer and ensure that all fixing screws supplied are used.
- electriQ and its distributors and dealers are not liable or responsible for damage or injury caused by improper installation, improper use or failure to observe these safety instructions. In such cases any guarantee will expire.

BUTTONS



- 1. **POWER BUTON** To turn the TV ON/OFF
- 2. **SOURCE BUTTON** To select the input source.
- 3. **MENU BUTTON** To enter the main menu.
- 4. **CH- BUTTON:** To select the previous channel
- 5. **CH+ BUTTON:** To select the next channel
- 6. **VOL- BUTTON:** To decrease the volume.
- 7. **VOL+ BUTTON:** To increase the volume.
- 8. **REMOTE CONTROL SENSOR** Receives signals from the remote.
- 9. **POWER INDICATOR:** In standby mode the indicator light will display red, when switched on the indicator light will display green.

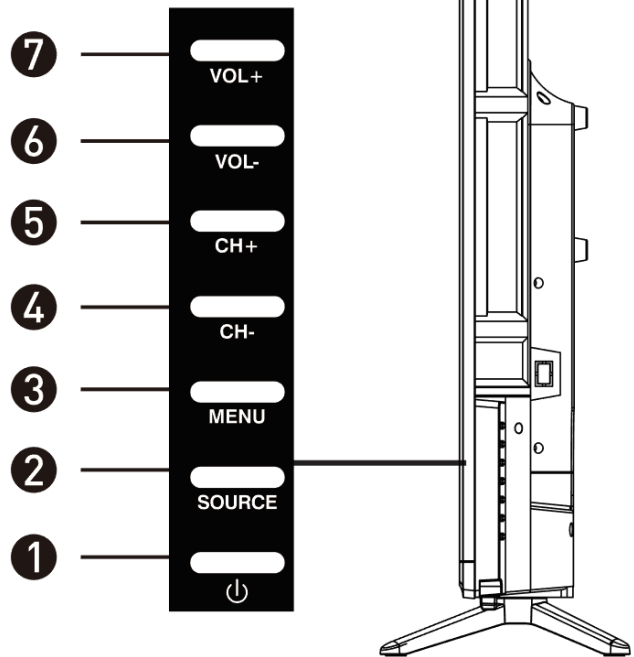

INPUT / OUTPUT TERMINALS

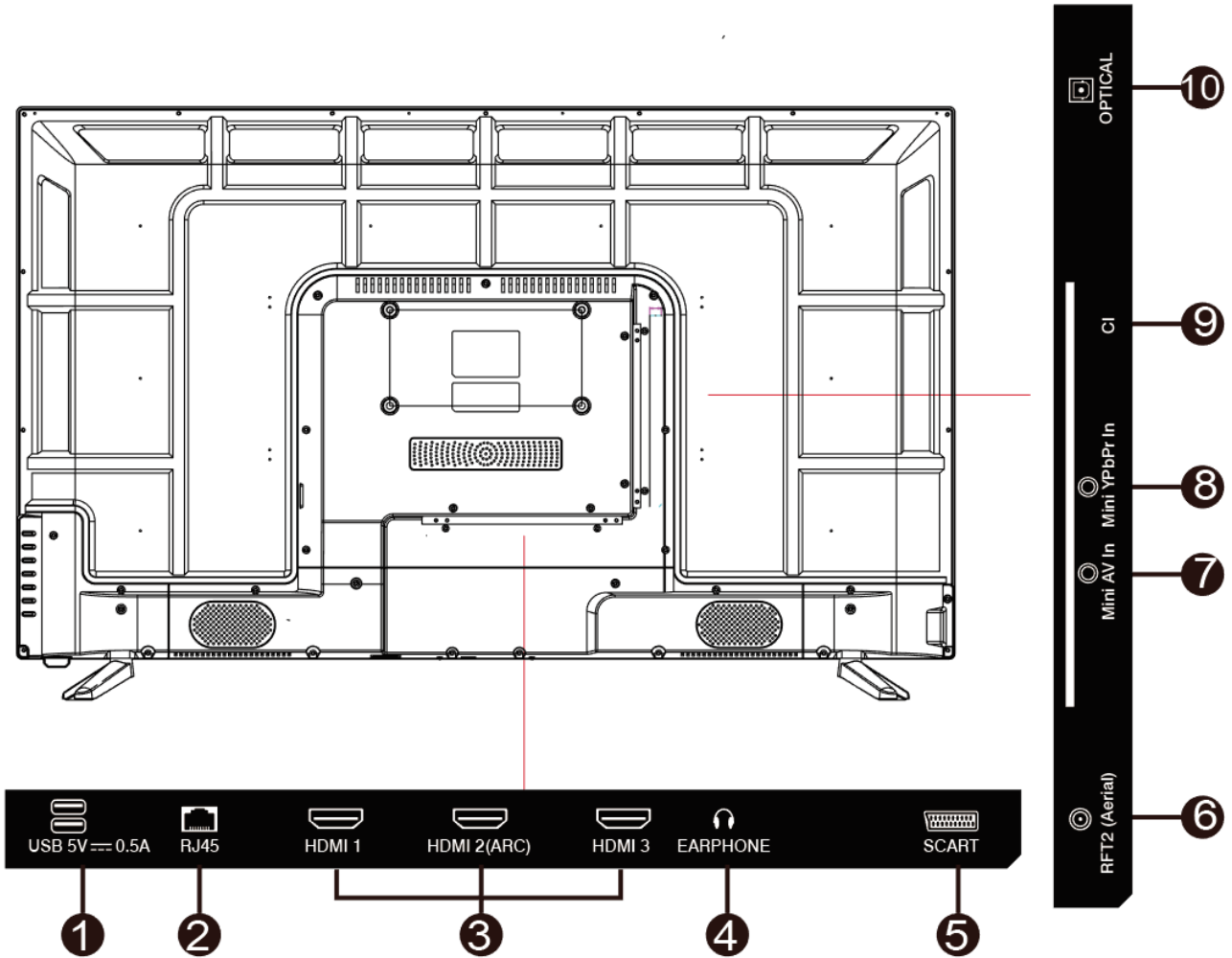

- 1. USB** Provides access to SMART TV. Connect smart remotes, keyboards, gaming accessories or USB flash drive. Can be used for DTV recording, time shift or as a media player file.





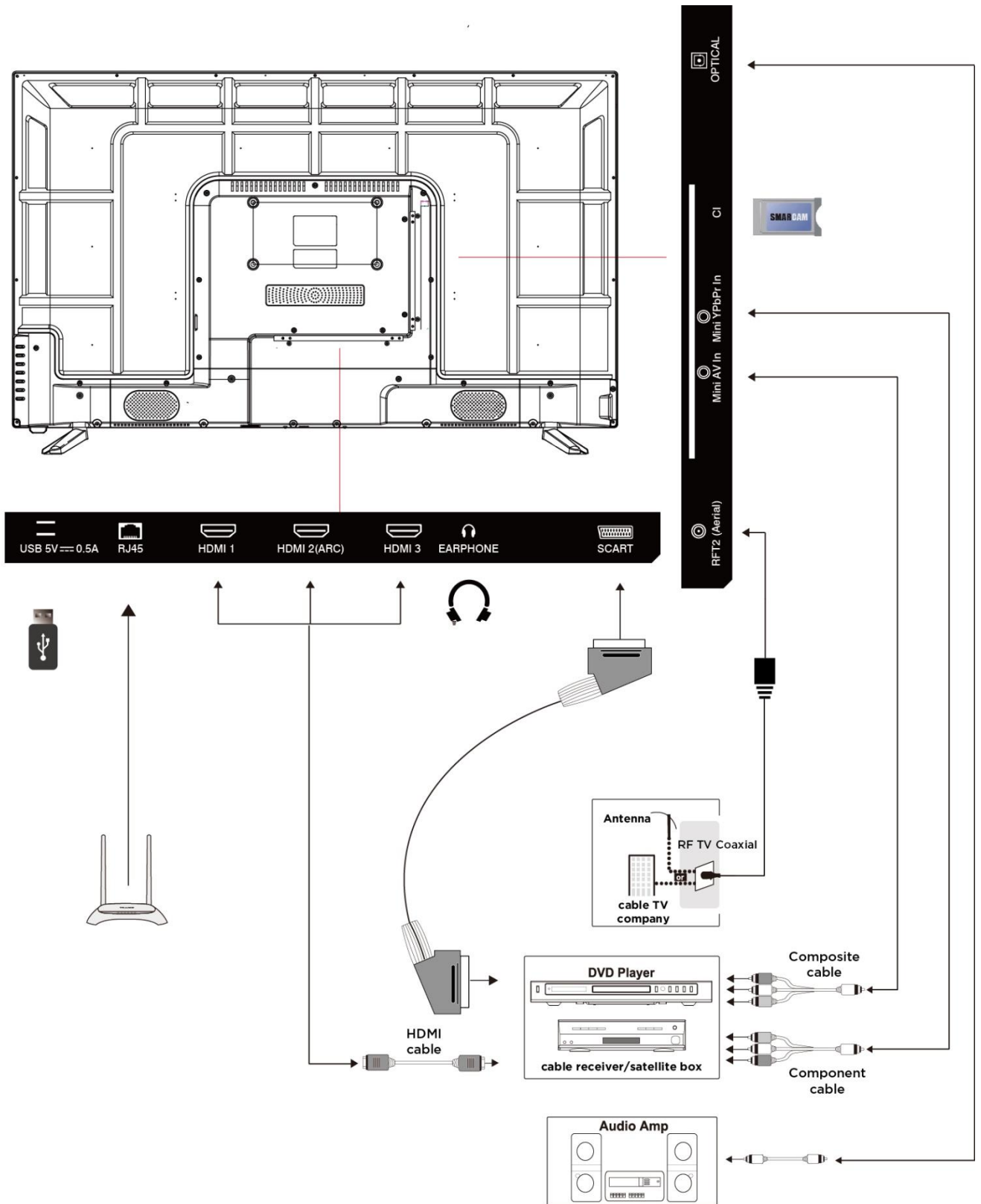



Note: only connect low power USB flash drives or externally powered hard drives to the USB ports as they only provide 0.5 Amps power.
- 2. RJ45** Wired network connection
- 3. HDMI x3.** DVD players, set top boxes, games consoles etc
- 4. EARPHONE** Earphones, headphones, or external speakers
- 5. SCART** For connecting older equipment such as VCRs
- 6. RF** Antenna connection.
- 7. Mini AV Input:** External AV signal input and right/left sound channel input.
- 8. Mini YPbPr:** Connect to the YPbPr video output terminal from a DVD player or similar
- 9. CI** For inserting a compatible CI card
- 10. OPTICAL:** Optical audio output.

CONNECTING TO EXTERNAL DEVICES



REMOTE CONTROL



1. STANDBY: Turn the TV On/Off
2. MUTE: Mute the sound.
3. 0-9: Press the buttons to select a channel
4. FAV: Favorite channel list.
5. MOUSE: Turn the remote control mouse On/Off.
: Return to previous channel.
6. AUDIO: Select TV audio mode between stereo/mono (While playing DVD/multimedia): Switch audio channel.
7. S.MODE: Set audio options
8. P.MODE: Set picture options
9. SLEEP: Auto power off timer.
10. VOL+: Increase the volume.
VOL -: Decrease the volume.
11. CH +: Next channel.
CH -: Previous Channel.
12. SOURCE: Select the signal source
13. INFO: Shows information about the current programme.
14. ASPECT: Press repeatedly to select the desired screen size.
15. FREEZE: To freeze the current picture.
16. : Go to the SMART homepage.
17. : Quick access to the SMART settings.
18. DIRECTION BUTTONS: used for menu navigation.
19. MENU: Enter the menu.
20. EXIT: Exit the menu or current operation.
21.  (MEDIA mode): Fast rewind
SIZE (within TXT): Sets size of the characters.
22.  (MEDIA mode): Next file or chapter.
HOLD: Hold the current page.
23.  (MEDIA mode): Previous file or chapter.
TEXT: Enter or exit teletext.
24.  (MEDIA mode): Fast forward.
REVEAL: Reveal hidden information
25. GUIDE: Enter or exit the electronic program guide.
26.  (MEDIA mode): Press to stop playback.
SUBPAGE (within TXT): Enter sub page mode.
27.  (MEDIA mode): Press to pause / play.
INDEX: Display the index page.
28. SUBTITLE: DTV mode select subtitle mode.
29. TV/RADIO: Change between TV or radio mode
30. R.LIST: Displays DVR list in DTV mode.
31. RECORD: DTV mode record to USB stick.
32. TIMESHIFT (Within DVR): Time shift
33. RED: Access the red item or page.
GREEN: Access the green item or page
YELLOW: Access the yellow item or page.
BLUE: Access the blue item or page.

INSTALLATION OF BATTERIES

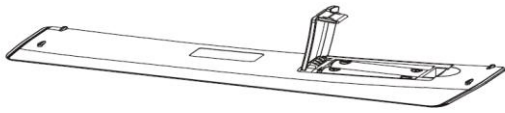

1 Remove the battery cover from the rear of the remote control.

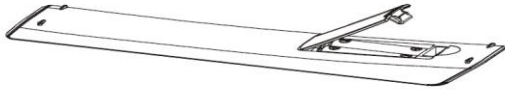

2 Install two AAA 1.5V batteries. (Ensure the correct polarity of the batteries.)

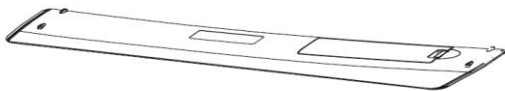

3 Replace the battery cover.

Please take out of the batteries from the remote when it is not going to be used for a long period of time.

If the remote control doesn't work properly, please carry out the following checks.

- Check the TV is turned on.
- Check the polarity of the batteries are correct.
- Check the batteries and replace if necessary
- Check the plug is fully inserted and the socket is switched on.
- Check there are no special fluorescent light or neon light which could interfere with remote signals.

INITIAL SETUP

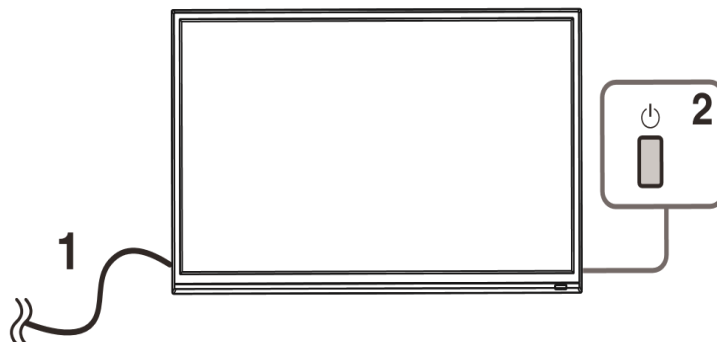

1. Connect your TV to the power outlet.
2. Connect your aerial and/or set top box to the television.
3. Press the POWER button on the remote to turn on the TV.
CAUTION: Always disconnect the TV from the power outlet when the TV will not be used for a long period of time. The POWER button on the television and remote is only used for switching the TV into standby and does not disconnect the device from the mains voltage. To completely disconnect the mains voltage, please remove the plug from the socket.
4. Use the ▼/▲/◀/▶ buttons on the remote to follow the setup guide on screen.

BASIC OPERATION

STANDBY MODE

- Press the STANDBY button to turn on the television.
- Press the STANDBY button again to return the television to standby mode. The power indicator will turn red.
- Be sure not to set your TV in standby mode for a long period of time.

SELECT THE INPUT SOURCE

USING THE REMOTE:

Press the SOURCE button to display the input source list.

Use the ▲ and ▼ buttons to select the input.

Press the ENTER button on the remote to confirm

USING THE TV CONTROLS:

Press the SOURCE button repeatedly to scroll through the input source list

TV MENU

Press the MENU button to display the main menu. The menu is split into 6 sub menus:

- Picture
- Sound
- Channel
- Setting
- Time
- Lock

Use the ◀ and ▶ buttons to change between the sub menus. Once the required sub menu has been selected, use the ▲ and ▼ buttons to select the setting within the sub menu to change. Then use the ◀ and ▶ buttons to amend the values. The MENU button can be pressed to navigate back a level in the menu, and the EXIT button can be used to exit the menu.

PICTURE SETUP

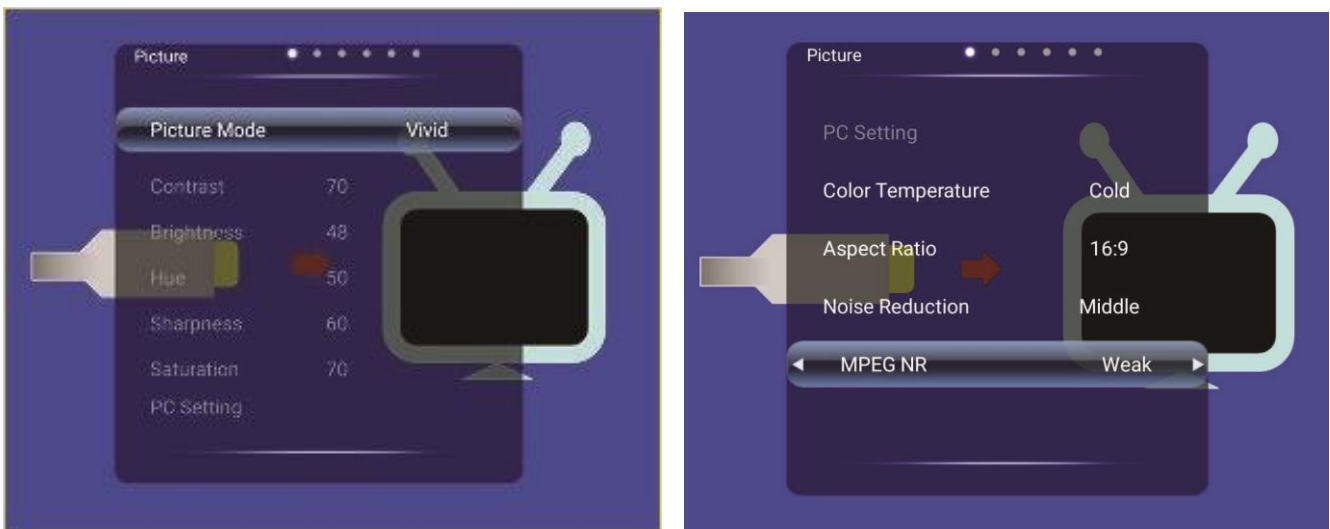

PICTURE MODE	Choice of 8 different picture modes: Standard, Soft, User, Game, Vivid, Natural Sports and Lightness. Individual picture settings are locked within each of the modes apart from User.
--------------	--

Within the User Picture mode the Contrast, Brightness, Hue, Sharpness and Saturation can be edited amend other settings, allowing the picture to be set to the users requirements.

COLOR TEMPERATURE	Used to set the colour temperature which is most comfortable.
ASPECT RATIO	Used to select the picture scale viewing mode required
NOISE REDUCTION	Used to reduce noise and improve picture quality
MPEG NR	Used to smooth the screen to reduce noise and improve image quality.

SOUND SETUP

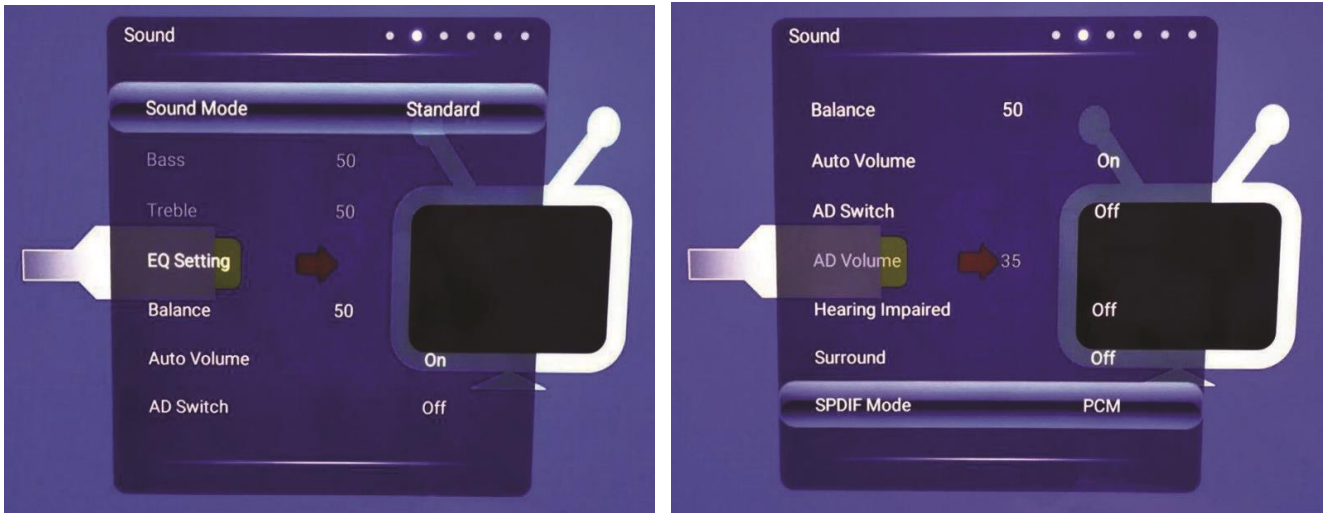

SOUND MODE	Select the sound mode required. When set to User, the bass and Treble can be amended.
EQ SETTING	Press to enter the equaliser to adjust the gain on individual frequency ranges.
BALANCE	Adjust the balance of the output between the left and right speakers.
AUTO VOLUME	Turn the auto volume control On / Off. When turned on if the volume exceeds a set value, it will be automatically reduced to protect the speakers / amplifier.
AD SWITCH	Designed for people with visual impairment.
HEARING IMPAIRED	This setting will make changes to the sound, improving the experience for users with hearing impairment.
SURROUND	Turn surround sound On / Off
SPDIF MODE	Select the Coaxial output mode.

CHANNEL SETUP

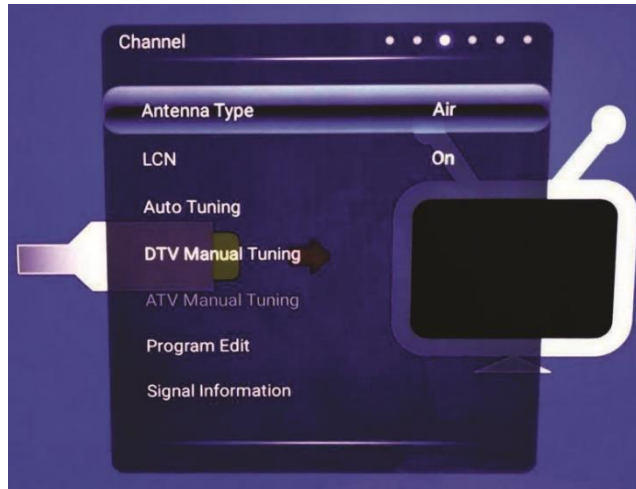

ANTENNA TYPE	Select the Antenna type between Air / Cable	
LCN	Select whether to use LCN to sort the channels.	
AUTO TUNING	Choose the Automatic search in the submenu, select your country, the TV will then search for all channels currently available in your area.	
DTV MANUAL TUNING	Enter the sub menu to make changes to the tuning for individual channels.	
PROGRAM EDIT	Use the ▲ and ▼ buttons to select the channel you wish to edit. The selected channel can be moved, deleted, jumped, or added to modify your channel list.	
SIGNAL INFORMATION	Displays information about the Strength and quality of the signal for each channel.	

SETTINGS

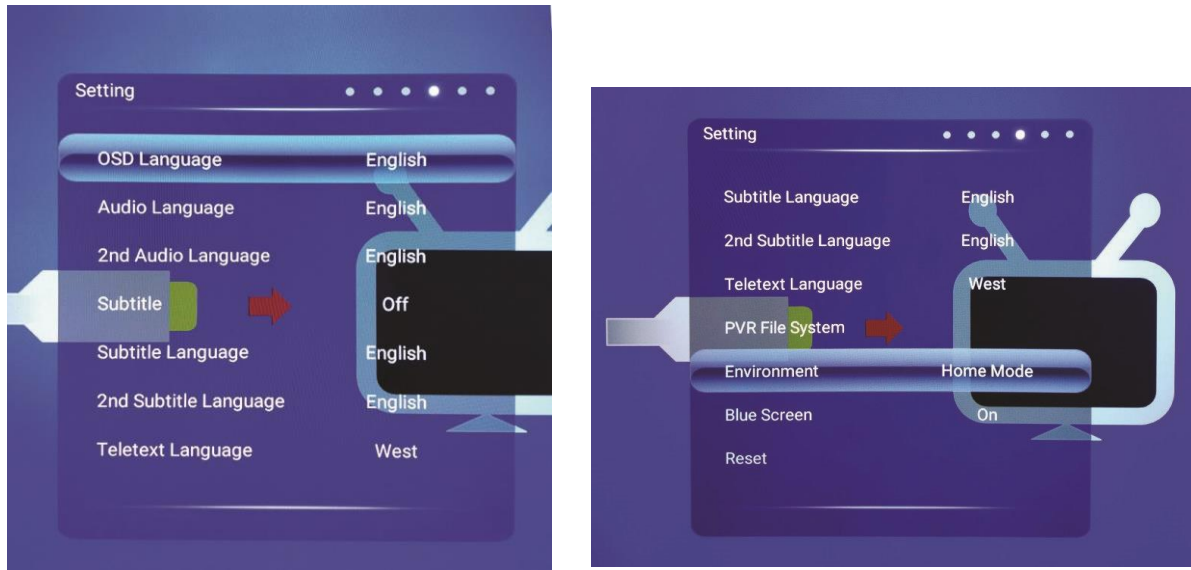

OSD LANGUAGE	Set the OSD language.
AUDIO LANGUAGE	Set the audio language.
2 ND AUDIO LANGUAGE	Set the 2 nd audio language.
SUBTITLE	Turn subtitles On/Off.
SUBTITLE LANGUAGE	Set the 1 st language for subtitles.
2 ND SUBTITLE LANGUAGE	Set the 2 nd language for subtitles.
TELETEXT LANGUAGE	Sets the language for teletext.
PVR FILE SYSTEM	Sets the file system used when recording within the PVR.
ENVIRONMENT	Change the mode between “HOME MODE” and “SHOP MODE”
BLUE SCREEN	Turn the blue screen (when no reception) on and off.
RESET	Reset the TV to factory defaults. A dialogue box will request confirmation before reset.

TIME

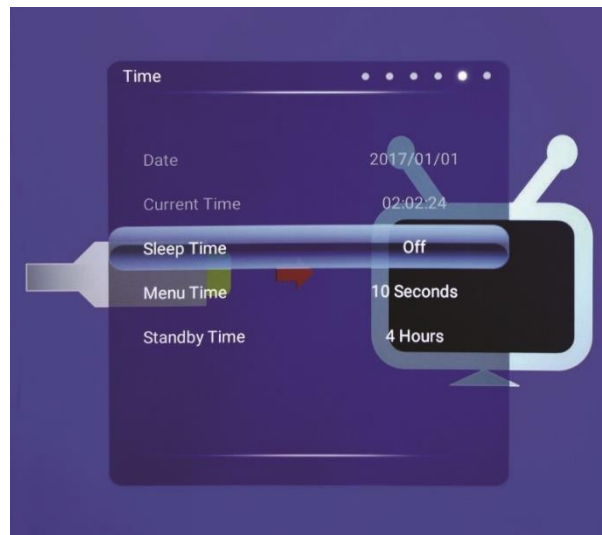

Date / Time	Shows the current date and time
Sleep time	Allows the system sleep time to be set.
Menu Time	Select how long the menu will be displayed on the screen without input
Standby Time	Select how long until the TV goes into standby when no input.

LOCK



Lock System	Allows the system lock to be activated and deactivated.
Set Password	Enter to set a password for the lock
Block Program	Enter to select a program to block.
Parental Guidance	Enter to set the parental guidance level.
Button Lock	Press to lock the controls
Hotel Mode	Enter to set Hotel Mode

LAUNCHER

Press the HOME button on the remote to enter the launcher.

Press the DOWN button to select the icons at the bottom of the screen, then use the left and right buttons to move between the TV, APP and MEDIA sections of the launcher.

Once the required section has been chosen, press the UP button to enter the section

Press the EXIT button to exit the launcher.

TV SECTION

Use the left and right buttons to change between the different input sources. Press the ENTER button on the remote to select the input source in the centre of the screen.

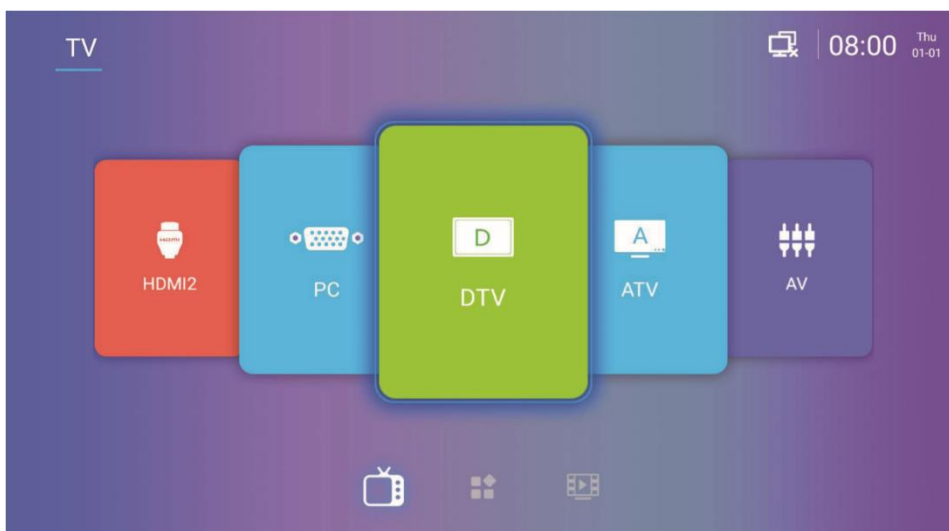

APP SECTION

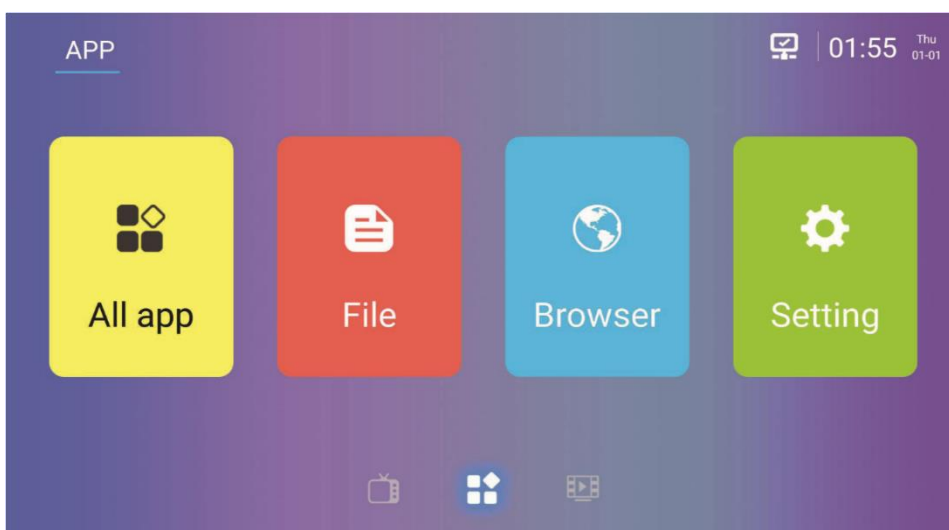

ALL APP	View all apps installed on the TV
FILE	Open the File manager to view files saved on the TV
BROWSER	Use to access the internet.
SETTING	Access and modify the Android settings.

SETTING

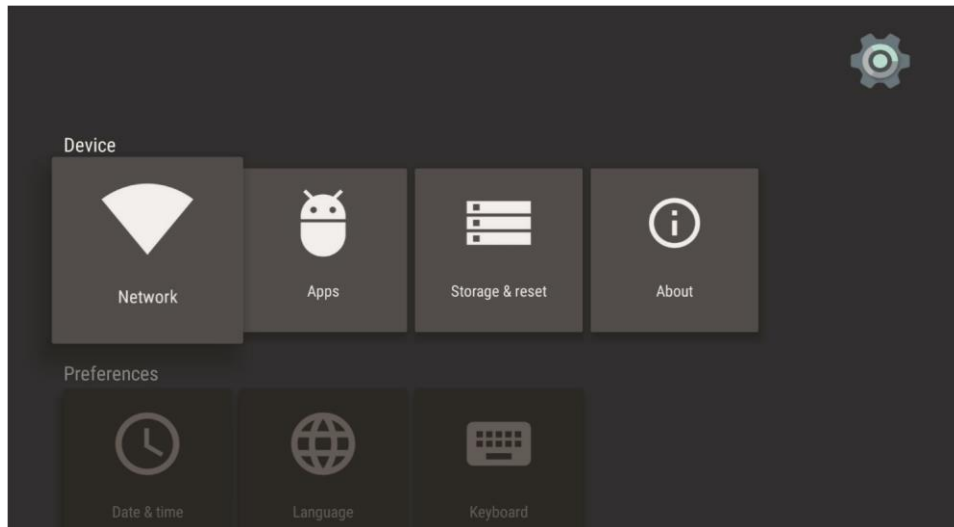

Network	Configure Network Settings
Apps	View and remove apps installed on the TV
Storage and reset	Gives storage information and the option to reset SMART features to factory defaults
About	System Info
Date and Time	You can make the adjustment to the date and time;
Language	You can change the language that is displayed
Keyboard	Configure the keyboard

MEDIA

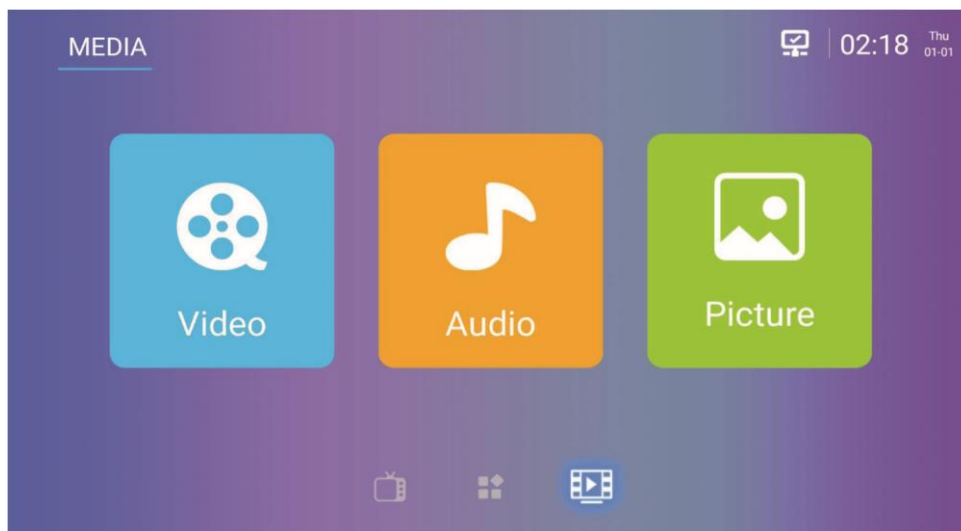

Within Media you can view Video, Audio and Pictures that have been saved to the TV or inserted memory stick.

TECHNICAL SPECIFICATION

Product Model		eiQ-43UHDT2SMH-V2
Screen Size		43" Diagonal
Aspect Ratio		16:9
Power Supply		AC 100-240V, 50/60Hz
Power Consumption		95W
TV System		PAL DVB-T2/-T/-C (There is no DVB-C signal in some Countries or Areas.)
Audio Output Power (Internal)		8Wx2
Input Terminal	Antenna Input	x 1
	USB Input	x 2
	HDMI Input	x 3
	VGA Input	NO
	PC AUDIO Input	NO
	Audio Input (L/R)	NO
	Video Input	x 1 (Mini)
	YPbPr Input	x 1 (Mini)
	RJ45 Input	x 1
	CI card In	YES
	SCART In	YES
	DC In (12V)	NO
	CARD SLOT	NO
	Output Terminal	Earphone
Audio Line Out(L/R)		NO
Video Output		NO
Optical		x 1
Coaxial out		NO
Working Temperature		0°C ~40°C
Working Humidity		20% ~ 80% Non-condensing

Note: Due to continued product development the specification shown above may change without notice.

SUPPORTED SIGNAL MODES

YPbPr MODE

Resolution	Horizontal Frequency (Khz)	Vertical Frequency (Hz)
480i	15.734	59.94
480p(720x480)	31.468	59.94
576i	15.625	50.00
576p(720x576)	31.25	50.00
720p(1280x720)	37.50	50.00
	45.00	60.00
1080i	28.13	50.00
	33.75	60.00
1080P(1920x1080)	67.50	60.00
	56.25	50.00

HDMI MODE

Resolution	Horizontal Frequency (Khz)	Vertical Frequency (Hz)
480p	31.468	59.94
576p	31.25	50.00
720p	45.00	60.00
1080i	33.75	60.00
1080p(1920x1080)	67.50	60.00
2160p(3840x2160)	67.50	30.00
2160p(3840x2160)	135.00	60.00

- *When the signal received by the display is not within the allowed range, a warning message will appear on the screen.*
- *You can confirm the input signal format onscreen.*

SIMPLE TROUBLESHOOTING

If the display fails or the performance changes dramatically, check the display in accordance with the following instructions. Remember to check the peripherals to pinpoint the source of the failure.

Symptom	Solution
Power cannot be turned on. (Power indicator does not illuminate.)	-Check that both ends of the power cable are plugged into the socket appropriately and the wall socket is operational
No Input Signal message appears.	-Check that the aerial cable is connected properly. -Check that the power of the relevant peripherals is turned on. -Check that the selected source matches the input.
The remote control does not function properly.	-Check the batteries are not drained.(Use new batteries.) -Check that the remote control is within the operating range. -Check that the remote control is pointed to the remote control window on the display. -Check that there are no obstacles between the remote control and the remote control window.
Flashing spots or stripes appear on the screen.	-Check that there are no emission (Car, HV cable or Neon lamp) or other possible interference sources.
Image colour or quality deteriorates.	-Check that all the video settings are adjusted appropriately, such as brightness, contrast, colour etc. -For more information about video settings, refer to OSD Functions
Screen position and size are incorrect.	-Check that the screen position and size is adjusted appropriately.
Image or colour is incorrect.	-Check that the signal line is connected properly. -When connecting to a PC, you can change the resolution of the PC to acquire the correct image. The discrepancy of the PC output signal may affect the display of the image.
Display warning message.	-Check that the input signal line is properly fixed. -Select the correct input signal. -For more information, refer to Supported Signal Modes

PRODUCT DISPOSAL



Do not dispose this product as unsorted municipal waste. Collection of such waste must be handled separately as special treatment is necessary.

Recycling facilities are now available for all customers at which you can deposit your old electrical products. Customers will be able to take any old electrical equipment to participating civic amenity sites run by their local councils. Please remember that this equipment will be further handled during the recycling process, so please be considerate when depositing your equipment. Please contact the local council for details of your local household waste recycling centres.

electriQ UK SUPPORT

Complete online support form on www.electriQ.co.uk/support

Service Line: 0871 620 1057

Office hours: 9AM - 5PM Monday to Friday

Unit J6, Lowfields Business Park,
Lowfields Way, Elland
West Yorkshire, HX5 9DA