

electric 

55 inch OLED TV



eiq-55UHDT2HOLED

OLED TV

CONTENTS



- WHAT'S INCLUDED-----4
- TV STAND INSTALLATION/REMOVAL----- 5
- GETTING STARTED-----6
- CONNECTING TO EXTERNAL DEVICES-----7
- REMOTE CONTROL-----8
- BATTERY INSTALLATION-----10
- SETTINGS-----11
- BASIC OPERATION----- 12
- SYSTEM SETTINGS MENU----- 17
- IMAGE SETTINGS MENU----- 20
- SOUND SETTINGS MENU----- 21
- CHANNEL SETTINGS MENU-----23
- FUNCTION SETTINGS MENU-----28
- TIMER-----33
- PVR-----36
- DTV-----38
- TROUBLESHOOTING-----39
- SPECIFICATION-----41
- SUPPORTING SIGNALS-----42

SAFETY INFORMATION

- Read these instructions – All the safety and operating instructions should be read before this product is operated.
- Keep these instructions – The safety and operating instructions should be retained for future reference.
- Heed all warnings – All warnings on the appliance and in the operating instructions should be adhered to.
- Follow all instructions – All operating and usage instructions should be followed.
- Do not use this equipment near water – The appliance should not be used near water or moisture e.g. in a wet basement or near a swimming pool.
- Clean only with a dry cloth. Do not use solvents or petroleum based fluids.
- Do not block any ventilation openings.
- Do not install near any heat sources such as radiators, stoves or other apparatus (including amplifiers) that produce heat.
- Do not tamper with the supplied plug. This plug is a BS1363 standard plug.
- Protect the power cord from being walked on or pinched, particularly at the plug and at the point where it exits from the appliance.
- Only use attachments/accessories specified by the manufacturer.
- Use only with a cart, stand, tripod, bracket or table specified by the manufacturer or sold with the apparatus. When a cart or stand is used, use caution when moving it to avoid any injuries or damage from it tipping over.
- Unplug the apparatus during lightning storms or when unused for long periods of time.
- Refer all servicing to qualified personnel. Servicing is required when the apparatus has been damaged in any way, such as when the power supply cord or plug is damaged, liquid has been spilled, objects have fallen into the apparatus, it has been exposed to rain or moisture, it does not operate normally or has been dropped.
- Please keep the unit in a well-ventilated environment.
- The TV set should only be connected to a mains power supply with 100-240V~ 50/60Hz 
- To prevent overload, do not share the same socket with too many other electronic components.
- Do not place any connecting wires where they may be stepped on or tripped over.
- Do not place heavy items on the cable as this may cause damage.
- When removing the plug from a socket, hold the plug, rather than the wires.
- Pull the plug out immediately and seek professional help if the plug or cable is damaged, liquid has spilt onto the set, if accidentally exposed to water or moisture, if anything accidentally penetrates the ventilation slots or if the set does not work normally.
- Do not remove the safety covers. There are no user serviceable parts inside. Trying to service the unit yourself is dangerous and may invalidate the product's warranty.
- Only qualified personnel should service this apparatus.
- To avoid battery leakage, remove exhausted batteries from the remote control when not in use for a long period.
- Do not block the ventilation slots on the back cover. The TV can be placed in a cabinet but ensure at least 5cm (2") clearance all around.

SAFETY INFORMATION

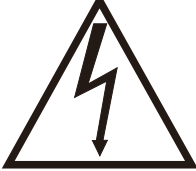
- Do not tap or shake the TV screen, this may damage internal components.
- **WARNING:** To reduce the risk of fire or electric shock, do not expose this apparatus to rain or moisture. The apparatus shall not be exposed to dripping or splashing. Objects filled with liquids, such as vases, shall not be placed on the apparatus.
- **WARNING:** The wall socket is used as a disconnection device and should remain readily accessible.
- **WARNING:** The batteries shall not be exposed to excessive heat such as direct sunlight or fire.

	RISK OF ELECTRIC SHOCK DO NOT OPEN	
<p>This warning sign is to warn of dangerous voltage inside the product.</p>	<p>CAUTION: To reduce the risk of electric shock, DO NOT remove the cover (or back). No user serviceable parts inside. Refer servicing to qualified service personnel.</p>	<p>This warning sign is to alert you of important instructions accompanying the product.</p>

This equipment is a Class II or double insulated electrical appliance. It does not require an earthed connection.

AT FULL VOLUME, PROLONGED LISTENING MAY DAMAGE THE USER'S HEARING.



WHAT'S INCLUDED

Please make sure the following items are included with your OLED TV. If any items are missing, contact your dealer.



TV Set



Remote Control (2xAAA batteries)

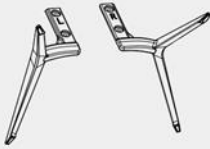

Base Stand
(Factory Fitted)



4 Bolts

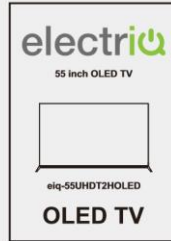

User Manual

TV STAND INSTALLATION/REMOVAL

STAND INSTALLATION

The television is supplied with the 2 legs factory fitted, and so the unit is ready for use. Should the legs not be needed (i.e. if wall mounted), they can be easily removed, by undoing the two bolts which hold each leg in position.

WALL MOUNTING INSTRUCTIONS (OPTIONAL):

- The TV is provided with mounting holes for a VESA approved wall mounting bracket (not supplied).
- The VESA mounting pattern is : 400x300mm and the size of the bolts is 4 x M6 x 12(not supplied).
- Do not use bolts longer than the size specified above for your model or damage will occur to the internal components.

NOTE: Do not install this product until this manual has been read and understood thoroughly. Please keep these instructions for future reference.

Due to the heavy weight and dimensions of the screen and its fragile nature, we recommend that it is unpacked and assembled by 2 people and professional installers are used to wall mount it (Wall mounting is optional). If you do not understand the instructions, or are unsure how to install this product, please contact a professional for assembly advice and assistance.

Careful consideration should be made regarding the location the television is to be wall mounted as some walls are not suitable for installation. If the television is to be mounted on drywall, the mount must be anchored into a wooden stud, concrete block or brick behind the drywall. Installing on drywall alone will not support the weight of the display.

When drilling holes it is particularly important to take care of electrical cables, water or gas pipes in the wall. Please follow the instructions provided by the wall bracket manufacturer and ensure that all fixing screws supplied are used. Electriq and its distributors and dealers are not liable or responsible for damage or injury caused by improper installation, improper use or failure to observe these safety instructions. In such cases any guarantee will expire.

GETTING STARTED

JOYSTICK FUNCTIONS

The joystick on the lower-left panel behind the TV will control the basic features, including the on-screen menu. To use the more advanced features, you must use the remote control.

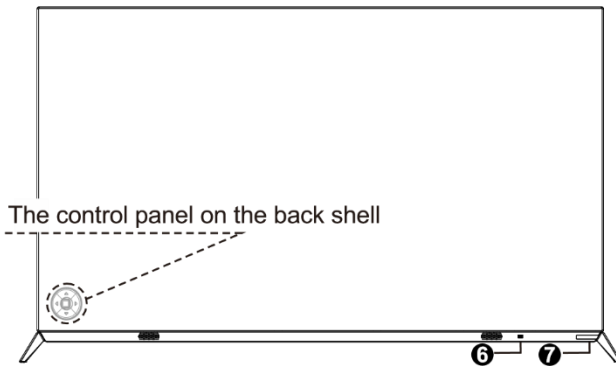

Directly in front the TV operation schematic diagram :

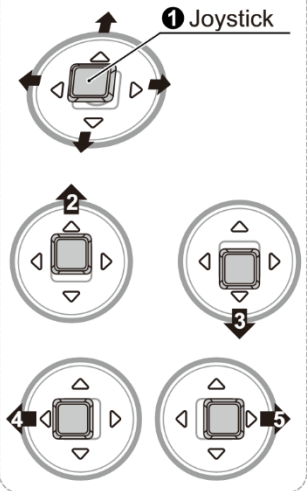

1	□ Centre	Press this button on the control panel one time to CONFIRM selection on menus. Press and hold this button to display FUNCTION menu at any menu. Press and hold this button to turn on the TV when it is in standby mode.
2	↑ Up	Push one time: Use to select menu item if menu on TV. Use to go to last channel when watching TV.
3	↓ Down	Push one time: If the menu is displayed, use to select the next menu item. Use to go to next channel when watching TV. Push and hold to return to the last page within the menu.
4	← Left	Push one time: Use to select the left menu item if menu on TV. Use to decrease volume when watching TV.
5	→ Right	Push one time: If the menu is displayed, use to select the right menu item. Use to increase volume when watching TV.
6	IR SENSOR	Aim the remote control towards this spot on the TV.
7	POWER INDICATOR	Light on: In standby mode. Light off: In power on mode.

CONNECTING TO EXTERNAL DEVICES

You can connect the TV with video devices such as a DVD player, VCR or a video camera to enjoy a high quality picture.

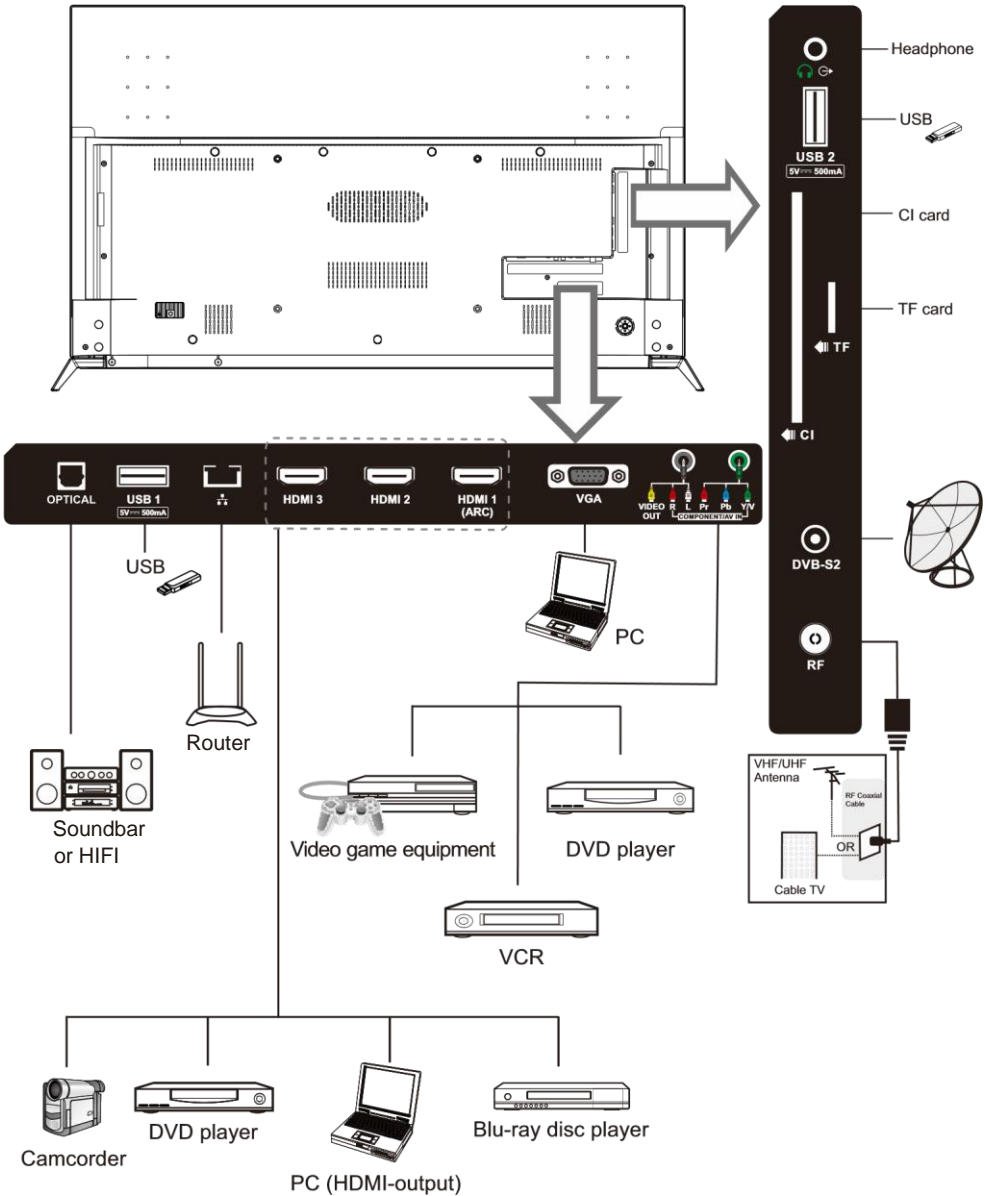

REMOTE CONTROL

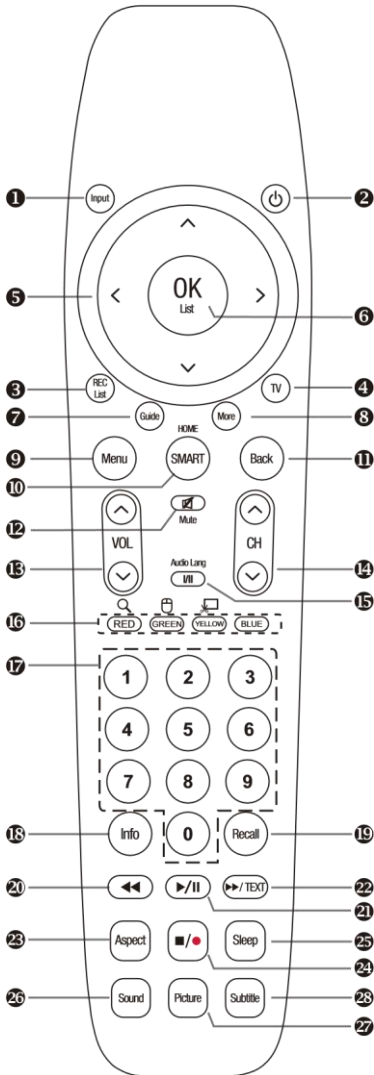

1. **INPUT:** This button is used to switch among different sources: DTV, ATV, AV, YPbPr, VGA, HDMI1, HDMI2, HDMI3. Select a source and press OK button to confirm.
2. **POWER:** Press this button to switch to standby mode, and press it again to turn the TV on.
3. **REC LIST:** Press this button to display a list of recorded programs in DTV.
4. **TV:** Press this button to enter TV source.
5. **Arrow buttons:** Press these buttons to move the cursor up / down / left / right within the menu.
6. **OK LIST:** Press this button to display a channel list, or confirm your selection.
7. **GUIDE:** In DTV source, this button is used to start the EPG application.
8. **MORE:** Press this button to display extended options within the menu. You can use virtual buttons in "more" menu to control TV functions with the remote.
9. **MENU:** Press this button to display the quick menu or exit the menu.
10. **SMART:** Press this button to enter the main SMART interface directly.
11. **BACK:** Return to previous page.
12. **MUTE:** Press this button to shut off of the sound from the TV, press again to restore the sound.
13. **VOL+ and VOL-:** Press these buttons to adjust the volume of the TV.
14. **CH Δ and CH ∇ :** Press these buttons to change the channel upward or downward. Within teletext, these buttons are used to display the next page and previous page.
15. **I/II button/AUDIO LANG:** In ATV source, the button is used to set NICAM sound system. In DTV source, the button is used to set the audio language.
16. **Red/Green/Yellow/Blue Command:** These four buttons are used to request linked buttons within the current menu/page. **GREEN button:** enables you to use the remote control to move a cursor. Long press on the **YELLOW button** to capture screen image. Press the **RED button** to switch the AD(Audio Description) function On/Off. When in the Home/Smart user interface, Press the **RED button** to open Google search.

REMOTE CONTROL

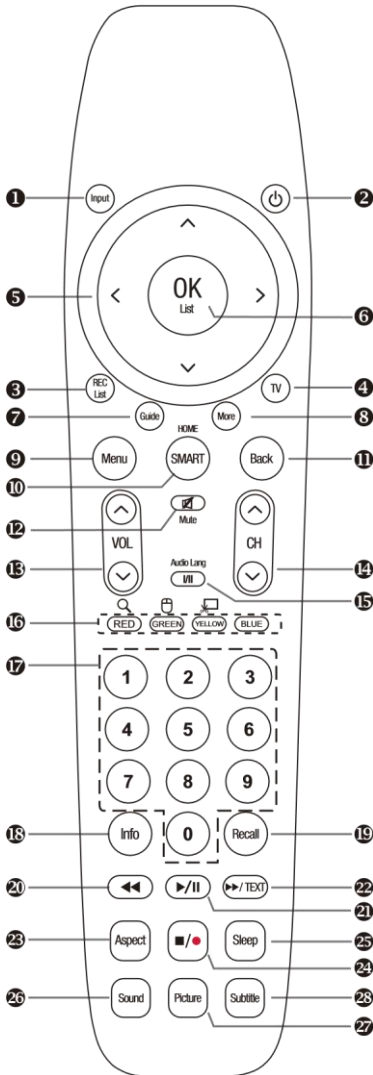

17. **Digital buttons(0-9):** To select channel with digital.
 18. **INFO:** This button is used to display source information or current program information.
 19. **RECALL:** Switch to the previous program.
 20. **◀◀:** Use as rewind function in USB Video/Audio playback Mode. Use as reveal function in ATV Text.
 21. **▶▶:** Use as Play/Pause function in USB Video/Audio playback Mode. Use as TimeShift function in DTV.
 22. **▶▶/TEXT:** Use as fast forward function in USB Video/Audio playback Mode. In ATV Mode, press this button to Enter Text Mode. Use as cancel function in ATV Text Mode.
 23. **ASPECT:** Press this button to switch the aspect ratio or scale mode.
 24. **■/●:** Use as a Stop function in USB video/Audio playback Mode. Use for the Record function in DTV.
 25. **SLEEP:** The TV will be switched off automatically at the end of the duration set for the sleep timer. Use your remote control to set the sleep timer. Repeatedly press the SLEEP button on the remote control to scroll through the timer lengths available: off, 10,20, 30, 60, 90, 120, 180, 240 mins.
- Notes: The sleep timer will be cancelled if the TV turns off or if a power failure occurs.**
26. **SOUND:** This button is used to select the sound mode.
 27. **PICTURE:** This button is used to adjust the picture mode.
 28. **SUBTITLE:** Turns the subtitles on or off in DTV or ATV Teletext mode.

BATTERY INSTALLATION

Installing Batteries

- 1** Open the battery compartment cover on the back

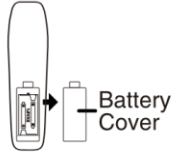

- 2** Insert two 1.5V AAA size batteries in correct polarity. Don't mix old or used batteries with new ones.

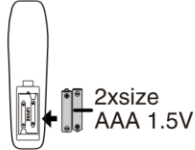

- 3** Replace the cover.

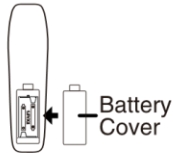

- ✦ Point the remote towards the remote control sensor of the TV and use it within 8 meters.

NOTES:

- Once installed, batteries will last for 1 year under normal use.
- If you do not intend to use the remote control for a long period of time, remove them to avoid damage due to leakage.
- Do not use old and new batteries together.
- The batteries should not be exposed to excessive heat such as sunshine, fire or the like

SETTINGS

INITIAL SETUP

How to turn the TV on or off

1. Insert the plug into the power socket.
2. If TV is in standby mode, press **POWER** ⏻ button on the remote control or press the joystick on the rear of the TV.
3. The picture will be displayed on the screen after 15 seconds. If no signal input, "No Signal" will be displayed on the screen.
4. If temporary POWER off is required, press **POWER** button on the remote control or press the joystick on the rear of the TV. The TV will enter standby mode.
5. If you want to completely switch off the power for the unit, unplug the tv, or switch off at the mains, after putting the TV into standby using the remote or the joystick on the rear of the TV.
6. After switching off the unit, you should wait at least 5 seconds before switching on again.



Status indication lamp

Light on: In standby mode.

Light off: In power on mode.

Auto power-off

1. If there is no signal, the TV will automatically enter standby mode after 10 minutes of inactivity.
2. In VGA mode, if there is no input for 15 seconds, the TV will enter standby mode.

Memory before turning TV off

The picture and sound settings and preset channels will be memorized at the point when the TV is turned off. When the TV is started up again it will work according to the previous settings.

BASIC OPERATION

Setup Wizard

When the TV is started for the first time, it will automatically enter the TV guide system.

OSD LANGUAGE SETTING

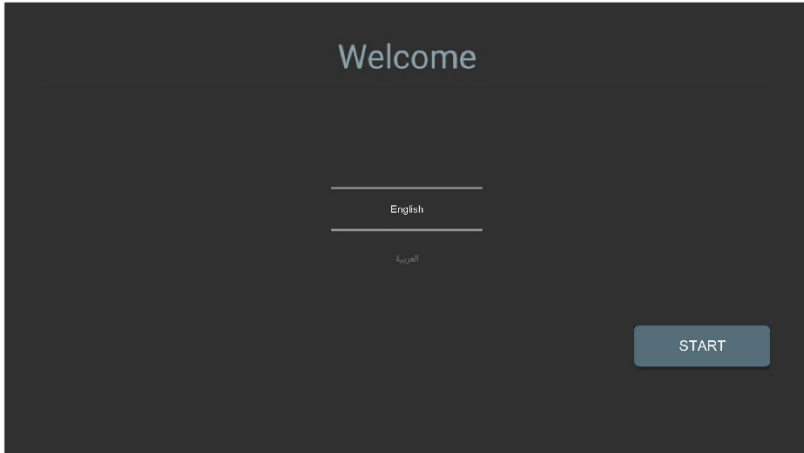

1. Press the ▲/▼ buttons to select the language.
2. Press the ► button then press the “START” button to continue to setup.

COUNTRY SETTING

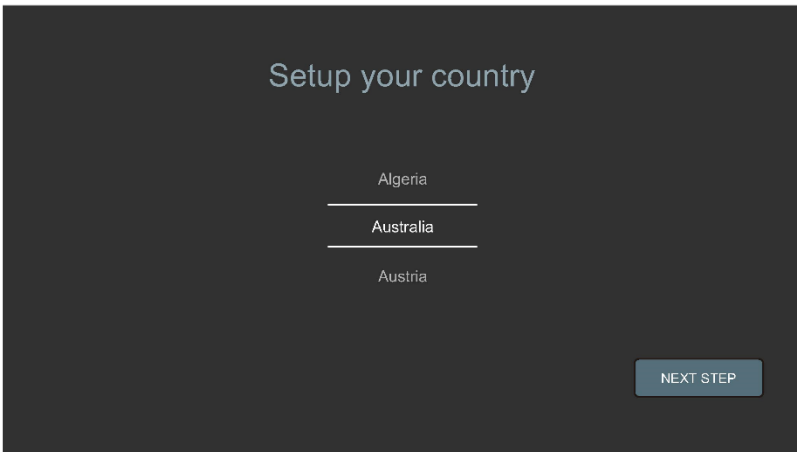

1. Press the ▲/▼ buttons to select your country (Algeria/Australia/Austria).
2. Press the ► button then select the “NEXT STEP” button to go to the next step.

NETWORK SETTINGS

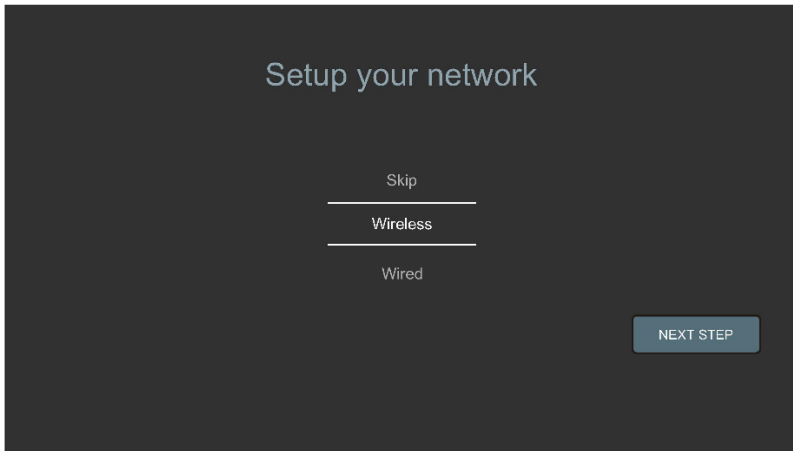

1. Press the ▲/▼ buttons to select the method of connection to your network(Skip/wired/wireless).
2. Press the ► button then press "NEXT STEP" button to enter the next step.

WIRELESS CONNECTION (WIFI)



1. Wait around 5 - 10 seconds for the list of available networks to be displayed.
2. Press the ▲/▼ buttons to select the network to connect to.
3. Select WIFI
4. Enter password and click "Connect".

WIRED CONNECTION



1. Press the ▲/▼ buttons to select the wired connection type (DHCP/STATIC).
2. Press the ► button then press "NEXT STEP" button to enter the next step.

If "DHCP" is selected, click "NEXT STEP", The connection is set-up automatically, then click Finish. Selecting "STATIC" allows the user to manually enter the IP address and default gateway. Once this has been entered click on "Set".

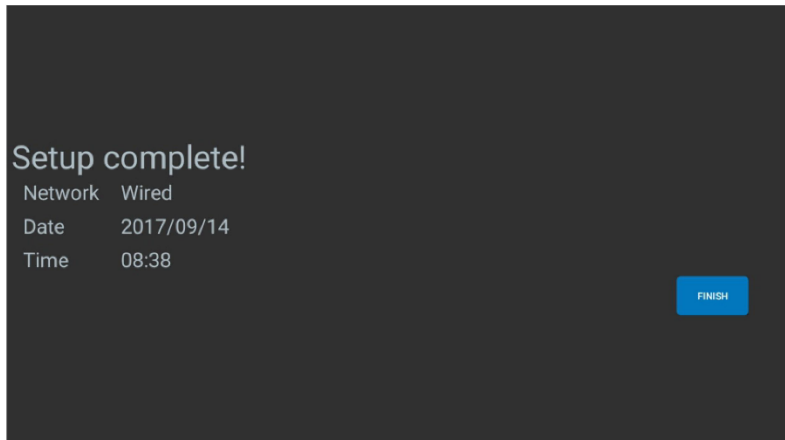

Explanation of Network types:

DHCP: The connection information is automatically assigned by your router, enabling a quick connection.

STATIC: Allows manual entry of IP address and other network settings if known.

In the majority of circumstances we would advise for the DHCP option to be selected.

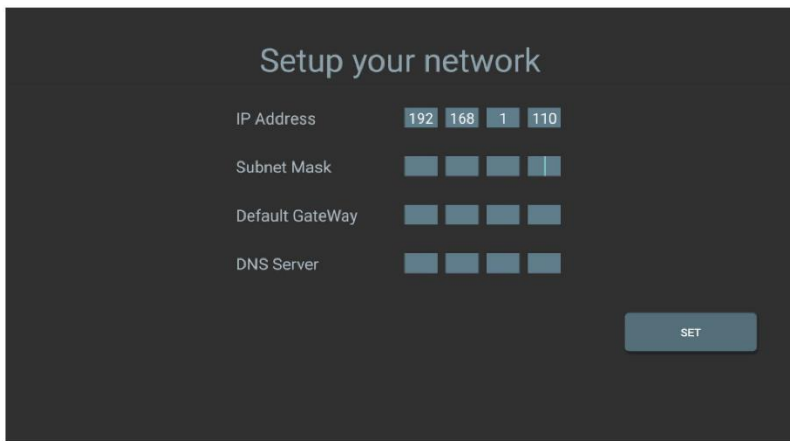

QUICK MENU



When viewing live TV, there is a Quick Menu to allow alteration of the most commonly changed settings.

MENU button: Opens the Quick menu or exits the menu.

BACK button: To exit the menu.

Arrow buttons: To select the required option.

OK button: Enter the option you have selected.

SMART MENU OPERATION

Accessible by pressing the SMART button on the remote

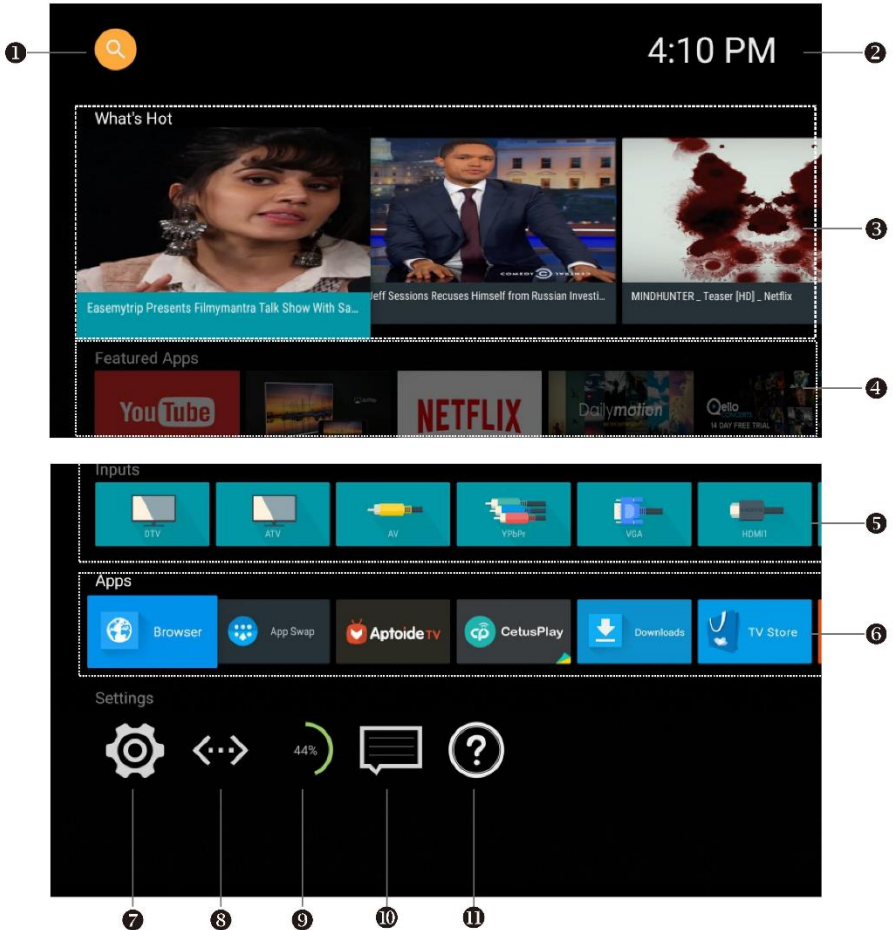

Arrow buttons: Select an item on the menu.

OK button: Enter the options which you've selected.

1. Google Search
2. Current Time
3. What's Hot: Popular videos from the Internet.
4. Featured app: Featured apps on the Internet for Smart TVs.
5. Inputs: Input sources available on TV (DTV, ATV, AV, YPbPr, VGA, HDMI1, HDMI2, HDMI3, USB2.0).
6. Apps: All applications installed on the TV.
7. System Settings: All Setting Options on the TV.
8. Network Status: Display your network status. Enter this option to make changes to your network connection.
9. RAM: Percentage of system memory that has been used.
10. Message Center.
11. Help.

SYSTEM SETTINGS MENU

MAIN MENU

This is accessible through the settings cog on the SMART MENU. This gives access to change the settings for all the TV's functions

TV

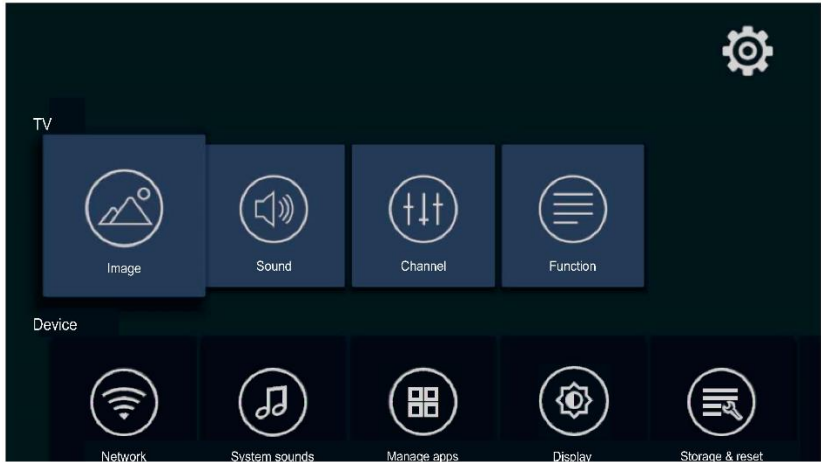

Image: Allows the screen settings for the TV to be changed. More in depth information can be found in the "IMAGE SETTINGS MENU" Section

Sound: Allows the sound settings for the TV to be changed. More in depth information can be found in the "SOUND SETTINGS MENU" Section

Channel: Allows the TV to be re-tuned. More in depth information can be found in the "CHANNEL SETTINGS MENU" Section

Function: Gives access to extra features within the TV. More in depth information can be found in the "FUNCTION SETTINGS MENU" Section

DEVICE

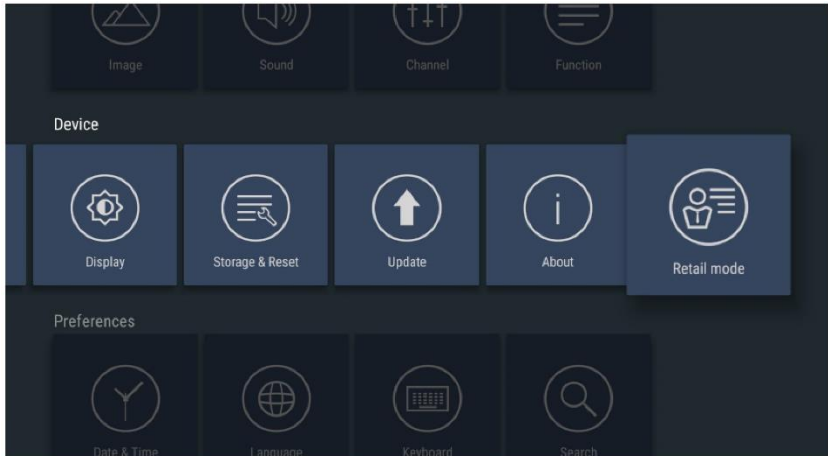
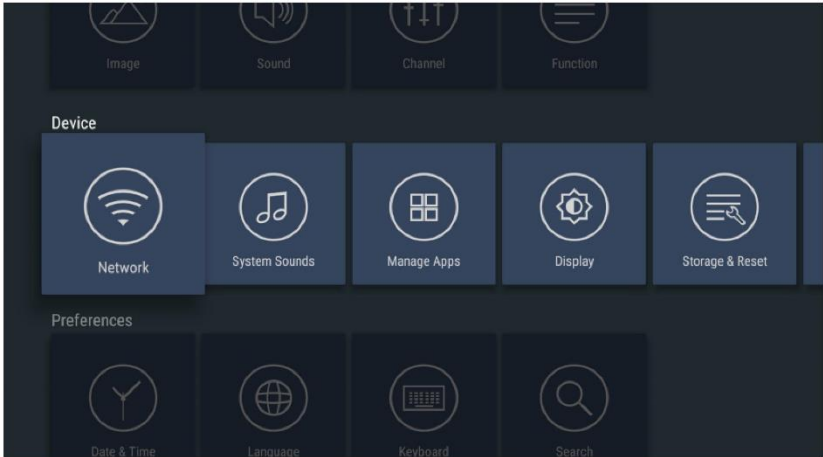

Network: Configure Network Settings;

System sounds: Configure sound settings for SMART mode;

Manage Apps: Allows removal of installed apps.

Display: Configure display settings for SMART mode;

Storage&Reset: Gives storage information and the option to reset SMART features to factory defaults;

Update: System Upgrade;

About: System info;

Retail mode: Retail mode (Use for retail store);

PREFERENCES

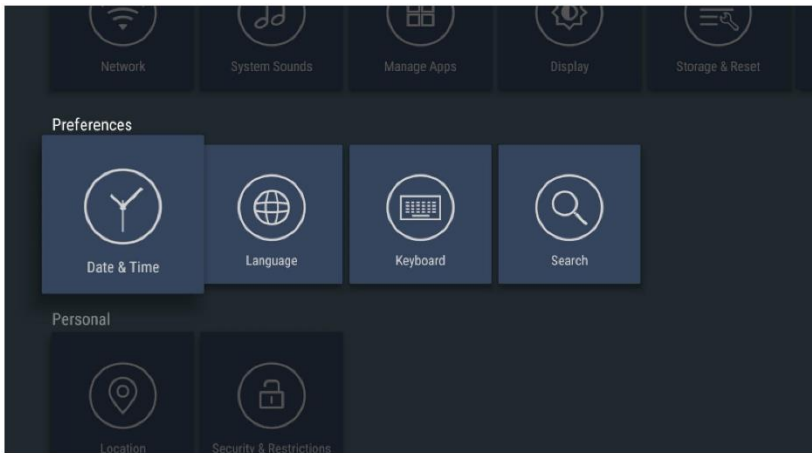

Date & time: You can make the adjustment to the date and time;

Language: You can change the language that is displayed;

Keyboard: Configure the keyboard;

Search: Google search;

PERSONAL

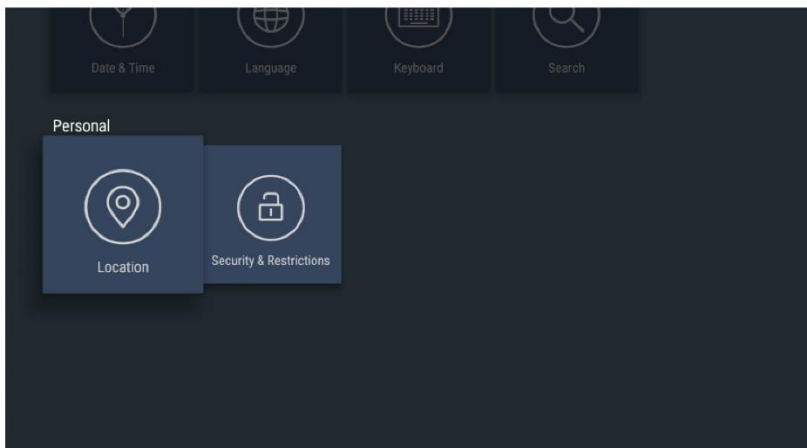

Location: Use network to provide location information;

Security & Restrictions: Security settings for the SMART feature;

IMAGE SETTINGS MENU

PICTURE MODE

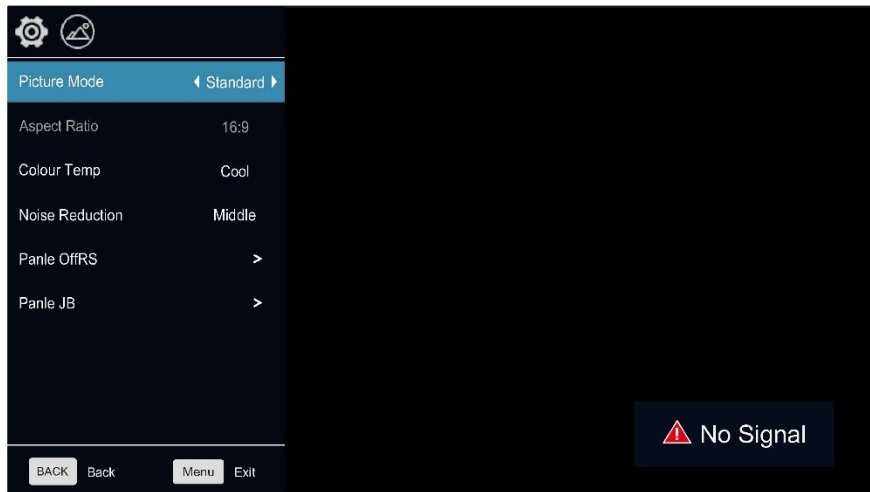

Your TV has these picture settings (Soft, Vivid, User, Dynamic, Standard) that are preset from the factory. Only “User” mode can be set to your preference by adjusting particular items such as Contrast, Brightness, Color, Sharpness, Tint.

1. Press the ▲/▼ buttons to select “Picture Mode” option.
2. Press the ◀/▶ buttons to select the picture mode.

Aspect Ratio

You can select the picture size which best corresponds to your viewing requirement.

1. Press the ▲/▼ buttons to select “Aspect Ratio” option.
2. Press the ◀/▶ buttons to set the scale mode. You can also press “Aspect” button on the remote control to select one of the scale modes. Each source has different scale modes.

Colour Temp

You can change the color of the entire screen according to your preference.

1. Press the ▲/▼ buttons to select “Colour Temp” option.
2. Press the ◀/▶ buttons to select your desired colour temperature.

Standard: Keeps whites white.

Warm: Makes whites reddish.

Cool: Makes whites bluish.

Noise Reduction

1. Press the ▲/▼ buttons to select “Noise Reduction” option.
2. Press the ◀/▶ buttons to adjust noise reduction mode.

Note: Noise Reduction is disabled in VGA Mode.

Panel OffRS

Use this function to clean ghosting on the screen. Tv will execute this function every 4 hours automatically. Keep the power on, this action takes about 8 minutes and then TV will enter standby mode.

Panel JB

Use this function to clean ghosting on the screen. Tv will execute this function every 1500 hours automatically. Keep the power on, this action takes about 70 minutes and then TV will enter standby mode.

SOUND SETTINGS MENU

SOUND MODE

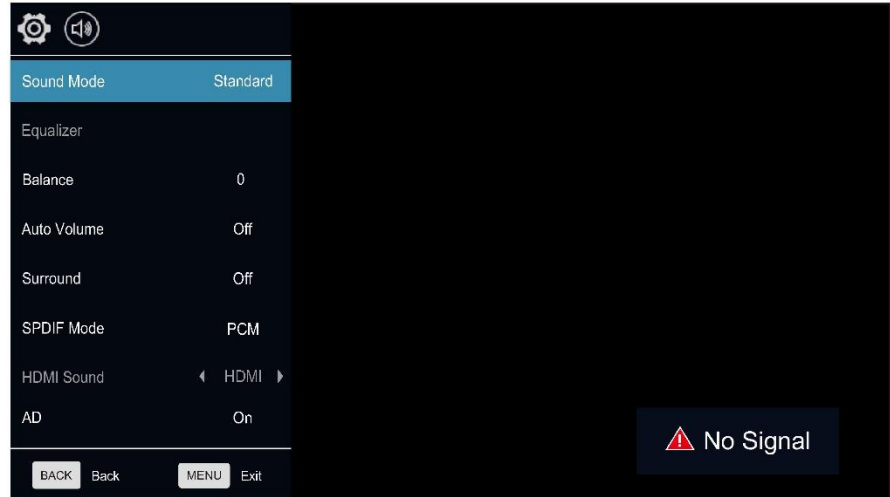

You can adjust the type of sound settings to be used when watching a given broadcast. Your TV has five sound settings ("Standard", "Music", "Movie", "Sports", "User")

Standard: Selects the normal sound mode.

Music: Select the sound mode for music.

Movie: Provides live and full sound for movies.

Sports: Emphasizes bass over other sounds.

User: Allows the sound to be customised using the equalizer.

Equalizer

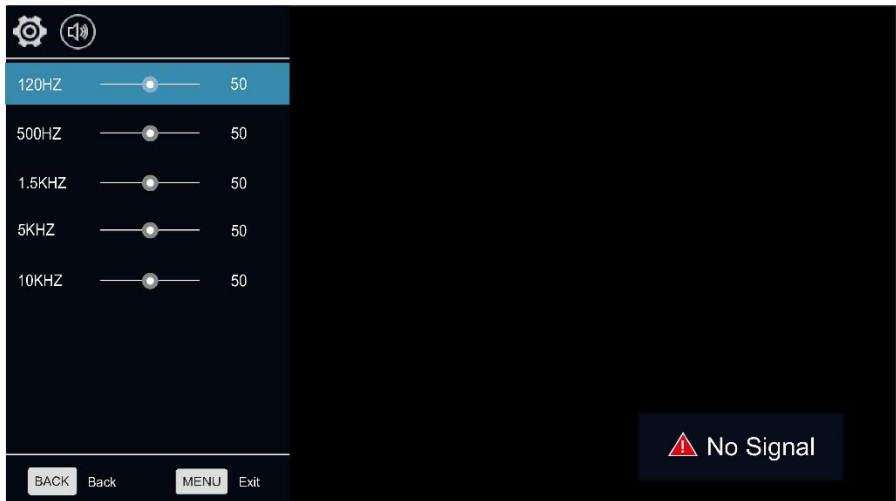

1. Press the ▲/▼ buttons to select an equalizer item.
2. Press the OK button to enter the equalizer submenu.
The sound settings can be adjusted to suit your user preferences.
3. Press the ▲/▼ buttons to select a particular item.
4. Press the ◀/▶ buttons to decrease or increase the value of the selected item.

Balance

If the volumes from the left speaker and the right speaker are not the same, from your usual sitting position, you can adjust the "Balance" to suit your preference.

1. Press the ▲/▼ buttons to select "Balance" option.
2. Press the ◀/▶ buttons to decrease or increase the value of the item.

Auto Volume

Each broadcasting station has its own signal conditions, and it is inconvenient to adjust the volume every time the channel is changed. "Auto Volume" automatically adjusts the volume of the desired channel by lowering the sound output when the modulation signal is high or by raising the sound output when the modulation signal is low.

1. Press the ▲/▼ buttons to select "Auto Volume" option.
2. Press the ◀/▶ buttons to select "On" or "Off".

Surround Sound

This is used to turn on surround sound to gain a better sound experience.

1. Press the ▲/▼ buttons to select "Surround" option.
2. Press the ◀/▶ buttons to select "On" or "Off".

SPDIF Mode

This is used to select "SPDIF Mode". This option is only used in HDMI/DTV mode.

1. Press the ▲/▼ buttons to select "SPDIF Mode" option.
2. Press the ◀/▶ buttons to select "RAW", "PCM" or "OFF".

HDMI Sound

This option is only used in HDMI mode.

1. Press the ▲/▼ buttons to select "HDMI Sound" option.
2. Press the ◀/▶ buttons to select HDMI Sound mode, HDMI or VGA.**Note: HDMI Sound is just enabled in source HDMI.**

AD (Audio Description)

This option is only used in DTV mode.

1. Press the ▲/▼ buttons to select "AD" option.
2. Press the ◀/▶ buttons to select "On" or "Off".

AD Volume

1. Press the ▲/▼ buttons to select "AD Volume" option.
2. Press the ◀/▶ buttons to decrease or increase the value of the item.

CHANNEL SETTINGS MENU

ANTENNA TYPE

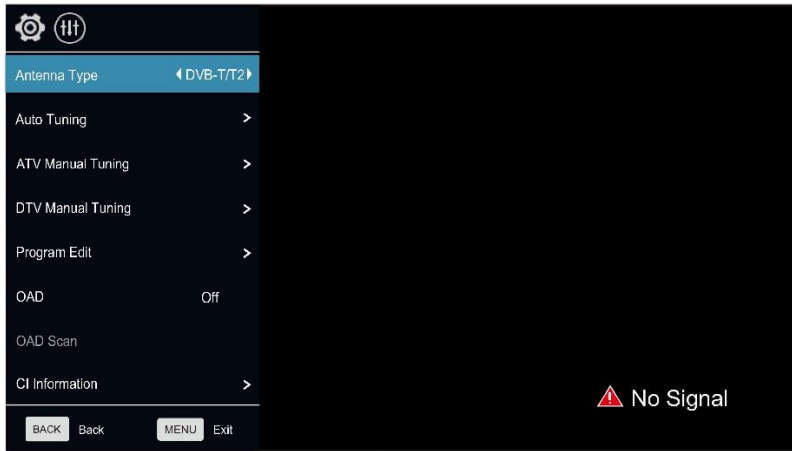

1. Press the ▲/▼ buttons to select "Antenna Type" option.
2. Press the ◀/▶ buttons to select the type of antenna: DVB-C (Cable), DVB T/T2 (Freeview), DVB-S (Freesat).

AUTO TUNING

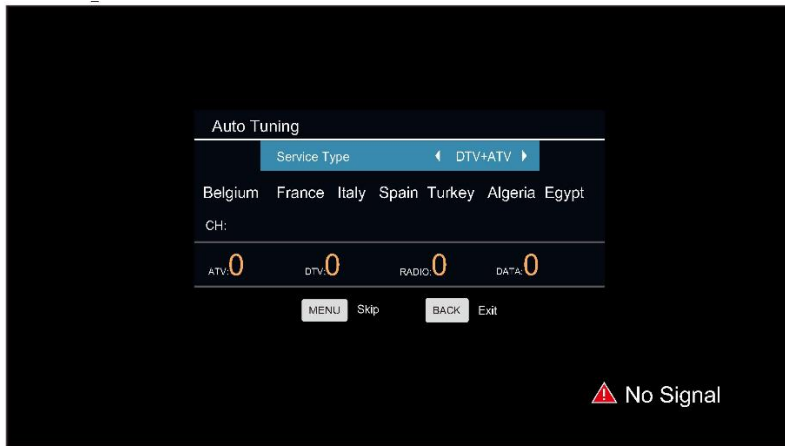

Press the ▲/▼ buttons to select the "Auto Tuning" option. You can select the country in the list view and set "Search Type" option. The number of channels found will be shown on the screen.

If you set "Tune Type" to "DTV+ATV", when the searching of DTV channels is over, the TV will start to search ATV channels. When the whole searching is finished, all the channels will be stored in memory.

If the Antenna Type is DVB-S, firstly you should set the DVB-S Option. You can set the satellite, scan mode, tune option etc in this menu.

Note: If you want to exit the whole searching, you can press BACK button, although this will not save any of the channels found.

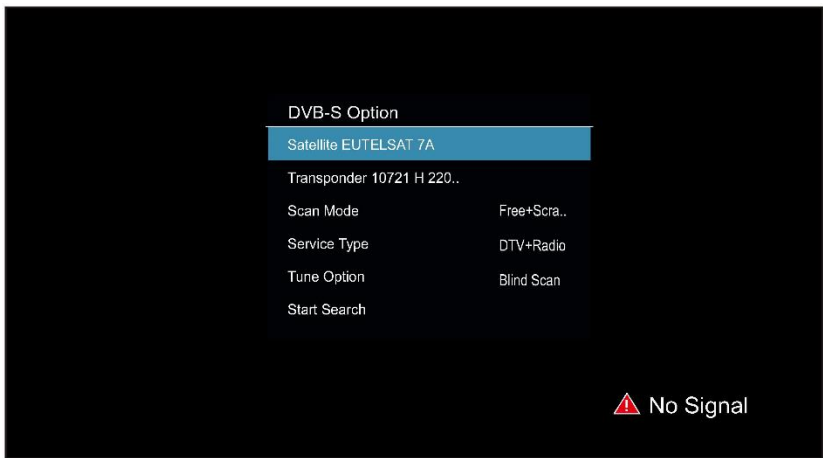

ATV MANUAL TUNING

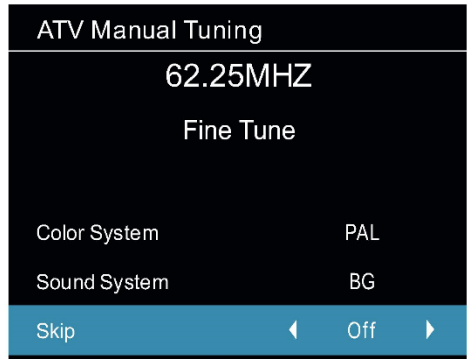

In the ATV/DTV source, you can choose "ATV Manual Tuning" to enter "ATV Manual Tuning" menu.

Current CH: You can see the current channel number and you can press the ◀/▶ buttons to choose the channel you want to modify.

Colour System: Select the "Colour System" option, press the ◀/▶ buttons to select the correct system. The color system will be changed in the order: PAL, SECAM, NTSC, or AUTO. The standard for the UK is PAL.

Sound System: Select the "Sound System" option, press the ◀/▶ buttons.

The sound system will be changed repeatedly in the below order: BG, DK, I, L or M.

Search: You can use the ▶ button to search channels from low frequency to high frequency and use the ◀ button to search channels from high frequency to low frequency. When you have searched for a channel, the searching will be paused and you can press it again for other channels after you the channel has been stored.

Fine Tune: In case of unfavorable image or sound on a particular channel, you can use "Fine Tune".

Skip: Select "Skip" option, "be changed" on the remote control or TV to switch, select "ON" to skip current program, select "OFF" to add the program into the program list.

Frequency: You can see the frequency of the searched channels.

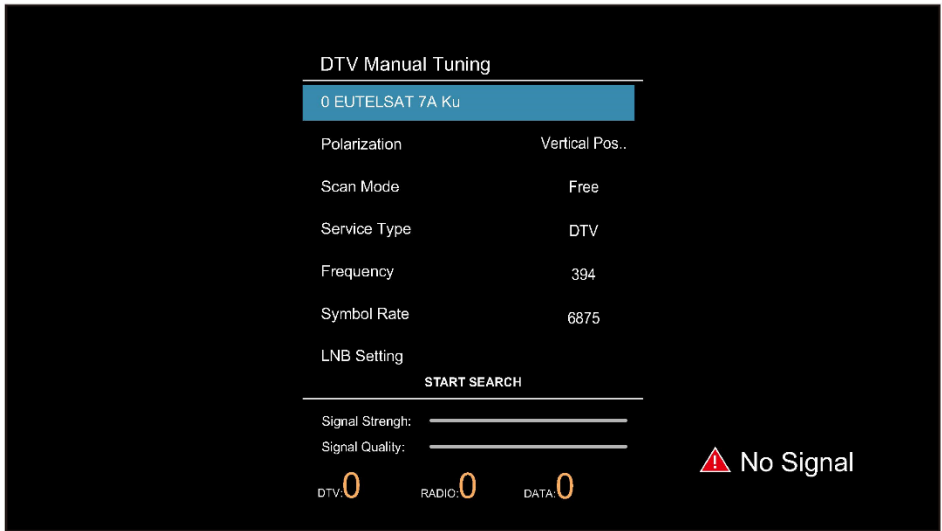

In the ATV/DTV source, you can choose "DTV Manual Tuning" to enter "DTV Manual Tuning" menu. If the Antenna Type is DVB-C (Cable), you can use the ◀/▶ buttons to choose the Frequency. If the Antenna Type is DVB-T (Freeview), you can use the ◀/▶ buttons or input number to choose the channel. If the Antenna Type is DVB-S (satellite), you can select the satellite and other settings. Then press OK button to search, the TV will store the DTV channel if there is a DTV signal present.

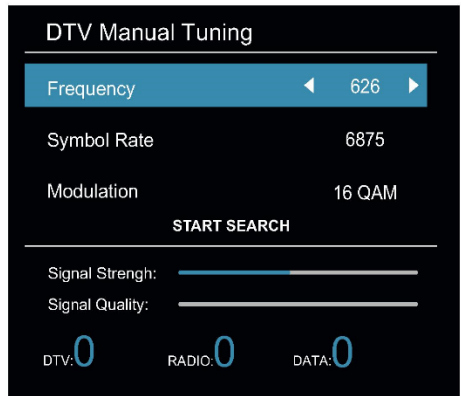
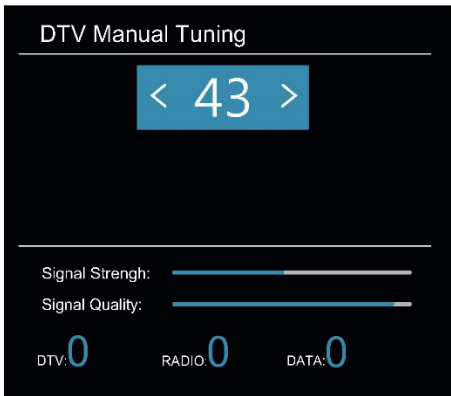

PROGRAM EDIT

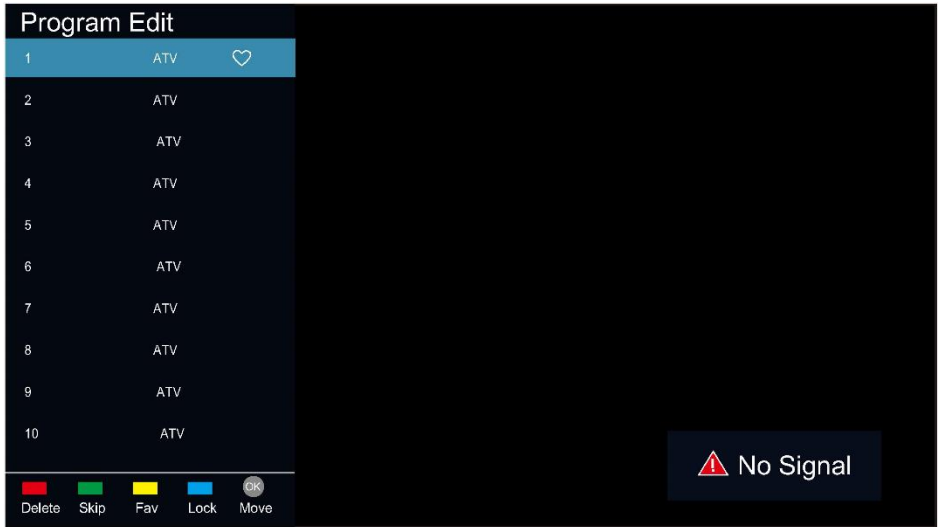

You can use the ▲/▼ buttons to choose "Program Edit" and enter the menu, press the colour buttons on the remote control to skip, delete and lock programs, or add programs to your favorite list.

Delete: You can press the RED button to delete the selected channel, then choose the channel you want to delete and press the RED button again to delete.

Skip: You can press the GREEN button to skip the channel. The channel will be skipped when you change channels. Also, the channel will not be displayed on the channel list.

Fav: You can press the Yellow button in the menu to add channels to your favorite list. Then you can press the ◀/▶ buttons on the remote to switch between the channel list and favorite list in list menu. **Lock:** If you don't want your children or your guest user to watch the channel without your permission, you can press Blue button to lock the channel. Once the channel is locked and the Lock System is on, a password is needed to view the channel.

Move: You can use the OK button to adjust the sequence of the programs.

SIGNAL INFORMATION (USED ONLY IN DTV)

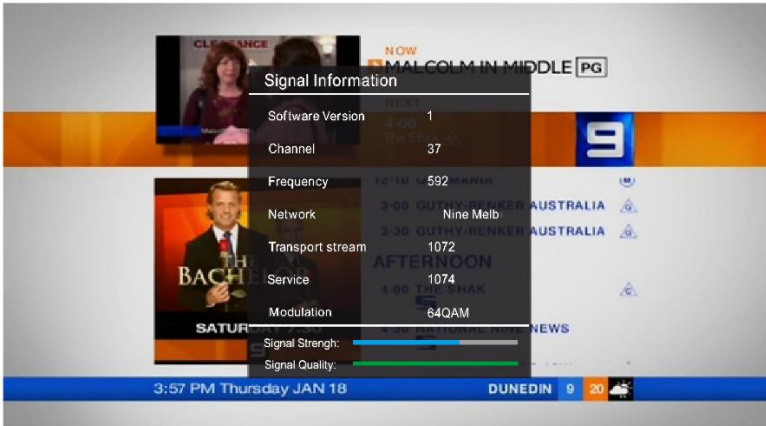

1. Press the ▲/▼ buttons to select "Signal Information" option.
2. Press the "OK" or ► button to see the information for the DTV channel.

Note:

Signal Quality/Signal Strength (DTV Only):

Unlike analogue channels, which can vary in reception quality, digital channels must have perfect reception quality or you will not receive them at all. As such you are not able fine tune a digital channel. If the signal strength indicates that the signal is weak, a possible solution is to adjust your antenna to increase the signal strength.

Continue to adjust the antenna until you find the best position with the strongest signal.

OAD (On Air Download)

This option is used to enable or disable system software update contained in DTV broadcasts.

1. Press the ▲/▼ buttons to select "OAD" option.
2. Press the ◀/▶ buttons to select "On" or "Off".

Note: This option is only used in DTV mode.

OAD Scan

This option only used in DTV mode.

1. Press the ▲/▼ button to select "OAD Scan" option.
2. Press the OK button to search for system software update files from DTV broadcasts.

CI Information

1. Press the ▲/▼ buttons to choose "CI information" and enter the menu.
2. Press "OK" button, you can see specific CI information including CI Module information, smart card information, etc.

Note: This option is only used in DTV mode.

LNB Setting

1. Press the ▲/▼ buttons to choose "LNB Setting" item.
2. Press "OK" button to display LNB Setting menu.

You can set specific setting to search DVB-S channels.

Note: This option is only used in DVB-S mode.

FUNCTION SETTINGS MENU

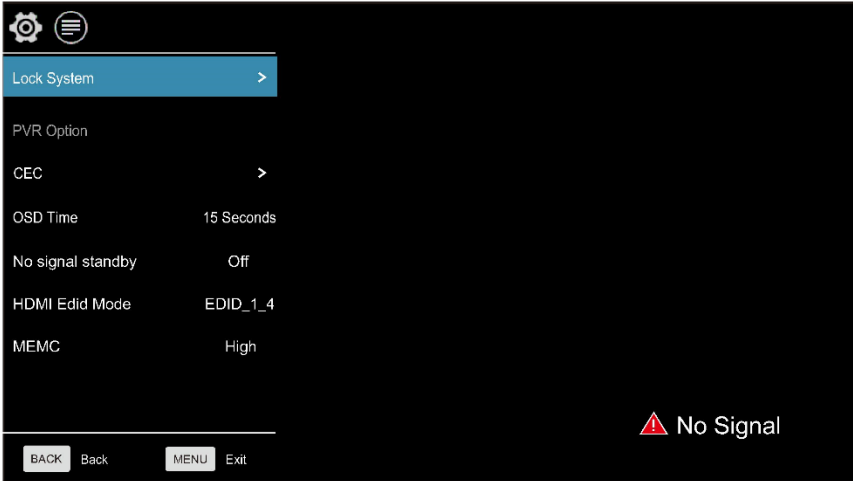

OSD Time: Set the preferred amount of time for the OSD (On Screen Display) to be displayed on the screen.

LOCK (OPTIONAL)

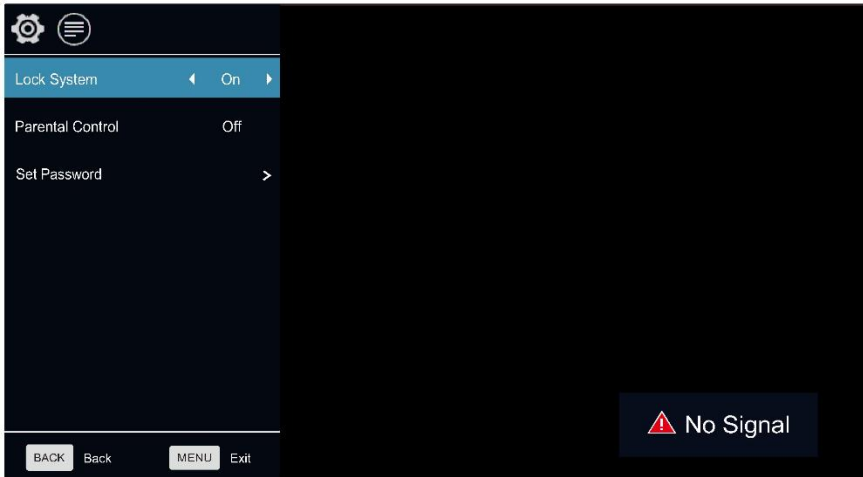

1. Press the "Enter" button to select the "System Lock" submenu.
2. Press the ◀/▶ buttons to turn the lock "On" or "Off".

SET PASSWORD

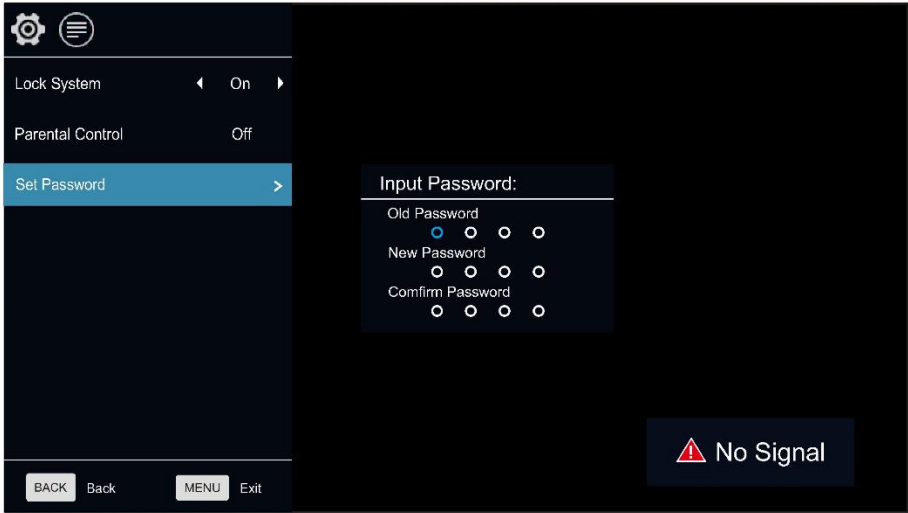

1. Press the “OK” button to select "Set Password" option.
2. Enter your 4-digit password for the old password. Choose any 4-digits for your new password and enter them. As soon as the 4 digits are entered, the cursor will skip to “Confirm password”, re-enter the same 4 digits, and your new password will be set.
(The default password is 0000).

PARENTAL CONTROL

This option only used in DTV mode.

1. Press ▲/▼ button to select “Parental Control” option.
2. Press ◀/▶ button to select the lock level of the Parental Control.

CEC

Consumer Electronics Control (CEC) is an HDMI feature designed to allow the user to command and control up-to 15 CEC - enabled devices ,that are connected through HDMI, by using only one of their remote controls (for example by controlling a television set, set-top box, and DVD player using only the remote control of the TV).

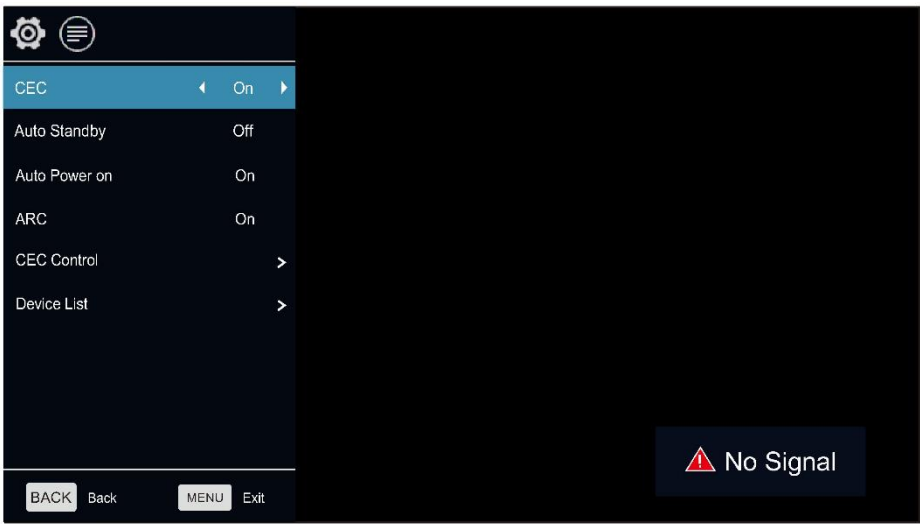

1. Press the ▲/▼ buttons to select “CEC” option.
2. Press OK button to enter “CEC” setting submenu. This option is used to enable or disable CEC.
1. Press the ▲/▼ buttons to select “CEC” option.
2. Press the ◀/▶ buttons to select “On” or “Off”.

Auto Standby

This option is used when CEC function is enabled, if enabled when the TV is turned off, it will also put any compatible CEC control device connected via HDMI into standby.

1. Press the ▲/▼ buttons to select “Auto Standby” option.
2. Press the ◀/▶ buttons to select “On” or “Off”.

Auto Power on

This option is used when CEC function is enabled, and will automatically turn on the TV, when a compatible CEC enabled device which is connected via HDMI is turned on.

1. Press the ▲/▼ buttons to select “Auto Power on” option.
2. Press the ◀/▶ buttons to select “On” or “Off”.

ARC

This option is used when CEC function is enabled, it enables the TV send audio to the device linked to itself in HDMI mode.

1. Press the ▲/▼ buttons to select “ARC” option.
2. Press the ◀/▶ buttons to select “On” or “Off”.

Note: ARC is only available in HDMI1 MODE.

Device List

This option is used when CEC function is enabled, it lists the devices linked to the TV.

1. Press the ▲/▼ buttons to select “Device List” option.
2. Press the OK button to show the devices linked to the TV.

CEC Control

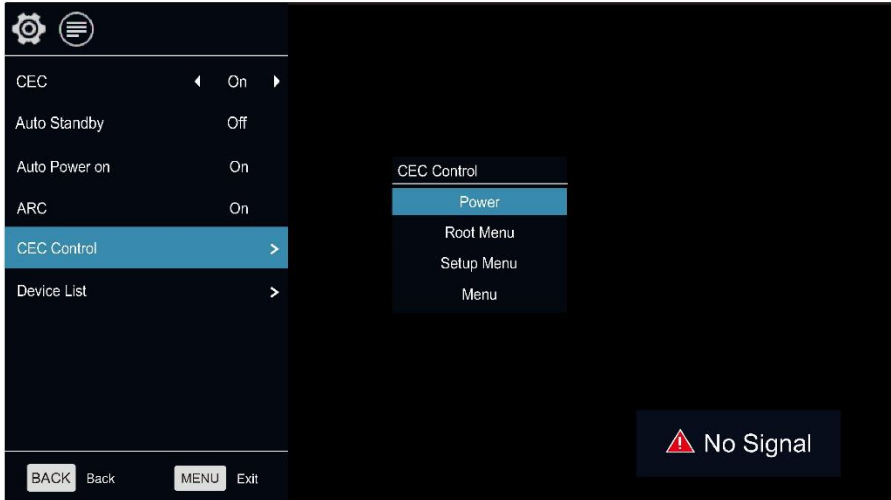

This option enables the TV to control the device linked to it.

1. Press the ▲/▼ buttons to select “CEC Control” option.
2. Press the OK button to enter the “CEC Control” submenu.

Power

1. Press the ▲/▼ buttons to select “Power” option.
2. Press the OK button to power off the device linked to the TV.

Root Menu

1. Press the ▲/▼ buttons to select “Root Menu” option.
2. Press the OK button to enter the root menu of the device linked to the TV.

Setup Menu

1. Press ▲/▼ buttons to select “Setup Menu” option.
2. Press the OK button to enter the setup menu of the device linked to the TV.

Menu

1. Press the ▲/▼ buttons to select “Menu” option.
2. Press the OK button to enter menu of the device linked to the TV.

PVR Option

1. Press the ▲/▼ buttons to select “PVR Option” option.
2. Press the OK button to enter “PVR Option” submenu, for detailed operation refer to “PVR”.

No Signal StandBy

1. Press the ▲/▼ buttons to select “No Signal StandBy” option.
2. Press the ◀/▶ buttons to choose “On” or “Off”. If set “On”, TV will auto standby after 10 minutes in “No Signal” states.

(In VGA mode, if there is no signal or operation, the TV will enter standby mode.)

Screen Saver

This option is only used in ATV mode.

1. Press the ▲/▼ buttons to select “Screen Saver” option.
2. Press the ◀/▶ buttons to select “On” or “Off”.

HDMI Edid Mode (Optional)

This option is only used in HDMI mode.

1. Press the ▲/▼ buttons to select “HDMI Edid Mode” option.
2. Press the ◀/▶ buttons to switch HDMI Edid Version.

MEMC(Optional)

Motion Estimate and Motion Compensation

1. Press the ▲/▼ buttons to select “MEMC” option.
2. Press the ◀/▶ buttons to change the MEMC level.



TIMER

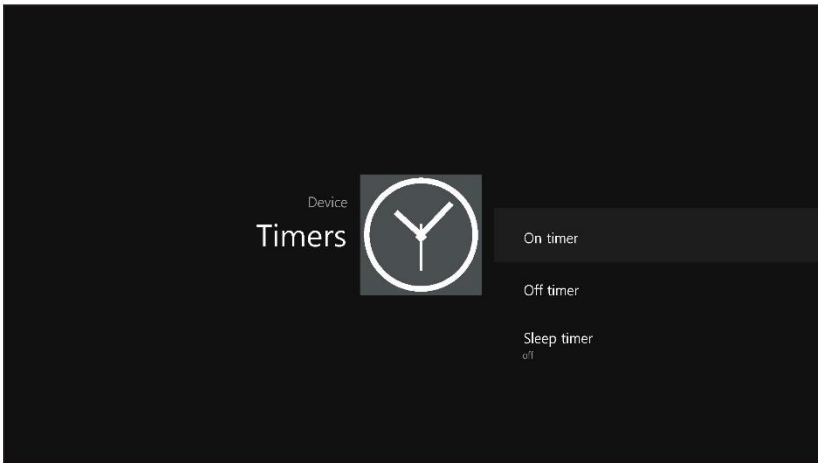
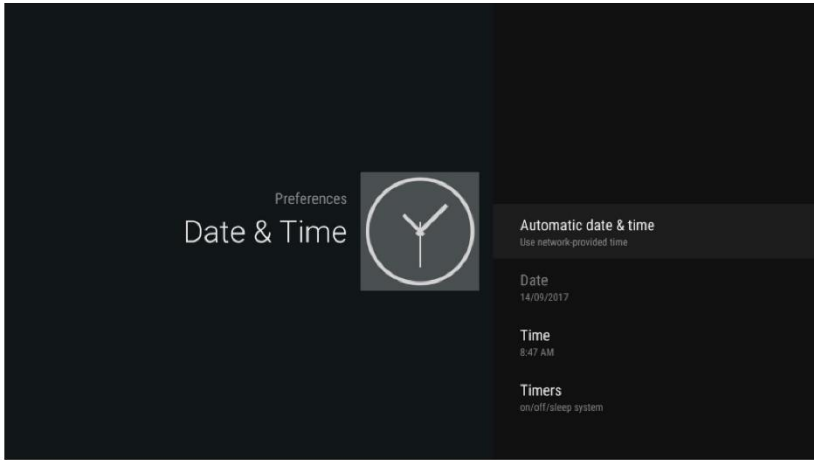

ON TIMER



Select the "On Timer", press the OK button to enter the submenu, set the time to turn on the TV set, when the TV set is in the standby mode. You can set a desired source to be displayed automatically when you start TV in "Source" menu.

OFF TIMER

Select the "Off Timer", press the OK button to enter the submenu, set the time to turn off the TV set.

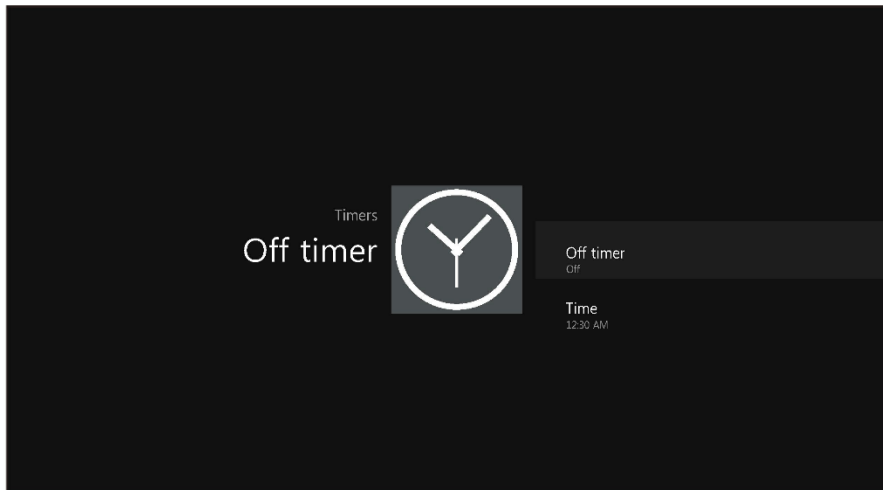

SLEEP TIMER

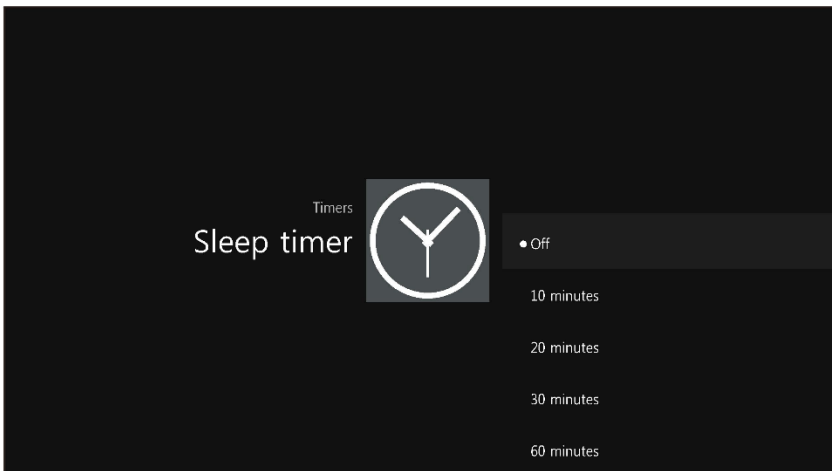

1. Press the ▲/▼ buttons to select "Sleep Timer" option.
2. Press the ◀/▶ buttons repeatedly until the desired time appears (Off, 10min, 20min, 30min, 60min, 90min, 120min, 180min, 240min).

Notes:

1. The sleep timer you have set will be cancelled when the TV turns off or if a power failure occurs
2. When the time is up, a reminder will be displayed on screen.
3. Press any button to cancel the timer function.

Audio Language

1. Press the ▲/▼ buttons to select "Audio Language" option.
2. Press the ◀/▶ buttons to set Primary Audio Language.

Note: This option only used in DTV mode.

Subtitle Language

1. Press the ▲/▼ buttons to select "Subtitle Language" option.
2. Press the ◀/▶ buttons to set Primary Subtitle Language.

Note: This option only used in DTV mode.

PVR

WARNING:

1. Before connecting your USB device to the TV, please back up your files to prevent data loss.
2. A USB disk must be formatted when first used for the PVR. Any existing data on the disk will be lost during the formatting process. Please back up your disk if you do not want to lose this data. You are recommended to use a dedicated disk for PVR use only. Do not disconnect the disk or power during formatting.
3. Do not modify PVR files on a PC.

Note: Make sure your USB device is compatible with the TV and able to support PVR recording.

Select Disk: Press "OK" button to enter submenu and press "◀/▶" to choose the disk for PVR.

Time Shift Size: Press ◀/▶ to choose the size.

Format Disk: Press "OK" button to enter the format submenu. The disk must be formatted when first used for PVR. Do not disconnect the disk or turn the power off during formatting. When formatting your disk, a progress bar will appear on the display.

Note: The larger your device the longer it will take to format. The device may take many minutes to format, this is not a malfunction, please wait for the formatting to finish.

Speed Check: Test your disk speed.

PVR Guide

If the disk for PVR is ready, the programs can be recorded in DTV mode.

PVR

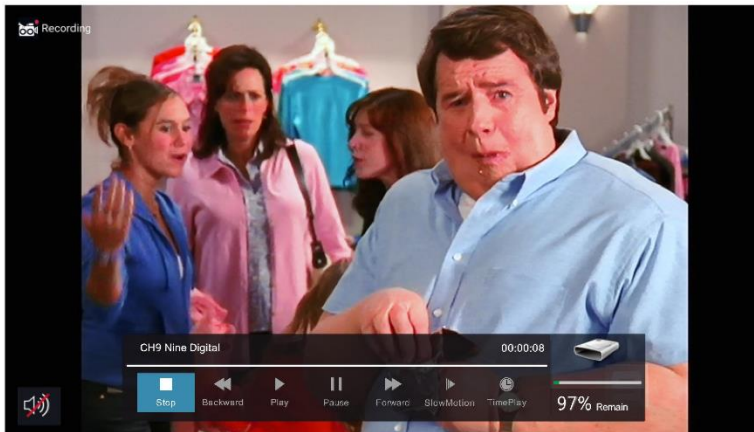

Time shift

In DTV mode, press ▶/|| button to pause the DTV program.

The length of time a program can be paused depends upon the setting in the PVR File System. Press "BACK" to stop the time shift.

Press the PLAY button to continue playing the program from the point where it was paused.

Note: Time Shift will stop if you change channels, change inputs or go into standby mode while in Time Shift mode.

Instant recording

1. Select the desired channel then press the ● button on the remote control to start recording the current broadcast, a progress bar will be displayed at the bottom of the screen.
2. Recording stops when you press the BACK button and the recorded file is stored in the external USB device automatically.

Note: You can only watch channels on the same frequency as the program being recorded. If you try to change to another channel or access the main interface a message will appear prompting you to continue and "stop recording" or remain on the current channel. The system will stop recording if the user confirms the change of channel.

Recording in standby mode

This unit is able to record while in standby mode.

Note: Start a recording then press the power button. A message will be displayed prompting you to standby, stop or cancel.

DTV

DTV EPG (Electronic Program Guide)



In DTV mode, press the "GUIDE" button to enter the Electronic Program Guide. Within the Guide menu, press the "RED" button to display the Add record menu, allowing changes to be made to the recording time before pressing OK to schedule the recording.

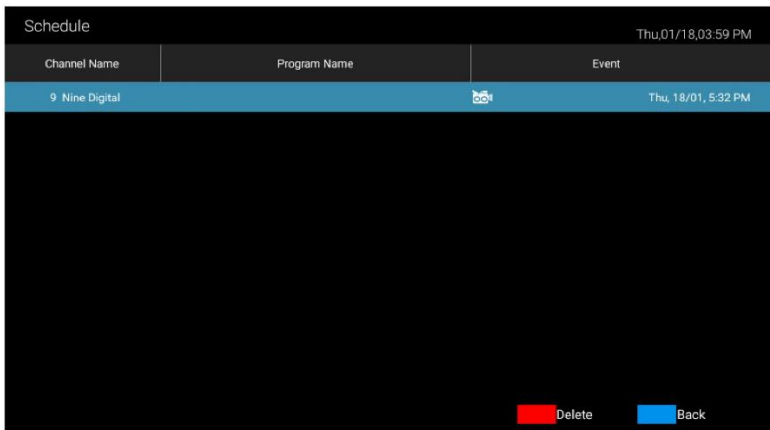

Within the Guide menu, press the "OK" button to set a reminder for a program. Note: Press the ◀/▶ buttons to adjust the scheduled time, press the "OK" button to save the setting.

Screen Shot

You can capture a picture of the current screen by holding the Yellow button for more than 1 second. The picture preview will automatically pop up if the capture succeeded.

Share to

When previewing the captured picture, you can press the OK button or choose by mouse to share it via Email, bluetooth to your friend, facebook, twitter etc. see the picture.

Note: This mode does not support bluetooth.

TROUBLESHOOTING

If you have any problem, check the solutions for each symptom listed below. The following symptoms may have been caused by inappropriate adjustment rather than a malfunction of the unit. If the problem persists, contact the Customer Care Centre, see back page for contact details.

Symptoms	Possible solutions
No power	Please check the power cord is plugged in and that the power outlet works. Unplug the power cord and plug it in after 60 seconds and restart the TV.
No picture	Please check antenna connection. Station may be experiencing problems, please tune to another station. Please adjust the contrast and brightness settings.
Good picture but no sound	Please increase the volume. Please check TV is not under mute mode, press MUTE button on the remote control. Please check sound settings If external devices are being used, check their volumes are not set too low or turned off. If using AVI or Component inputs, please make sure cables are connected properly and not loose. If using DVI to HDMI cable, a separate audio cable is required. Make sure a headphone jack is not connected.
Good sound but abnormal color or no picture	Please check antenna connection and antenna condition. If using Component input, please check Component connections, incorrect or loose connections may cause colour problems or cause the screen to be blank.
No response to remote control	Batteries of remote control may have exhausted, if necessary, please change the batteries. Clean the remote control lens. The distance between OLED TV and remote control should be within 8m, within recommended operating angle and path is free of obstructions.
Full screen flickering under VGA	V-HEIGHT value may be set too high, restart the computer and enter safe mode, set monitor parameters to correct value according to adjustment description.
Horizontal stripes under VGA	Sample phase may be deflected, adjust phase according to picture position.
Colored dots may be present on the screen	Although the OLED screen is made with high-precision technology and 99.99% or more of the pixels are effective, black dots may appear or bright points of light (red, blue, or green) may appear constantly on the OLED screen. This is a structural property of the OLED screen and not a malfunction.
Picture is breaking up	Keep the TV away from noisy electrical sources such as cars, hair dryers, welders, and all optional equipment. Electrical atmospheric interference such as local or distant lightning storms may cause picture to break up. When installing optional equipment, leave some space between the optional equipment and the TV. Check the antenna and connection. Keep the antenna away from any power or input/output cables.

After Auto Tuning, only some channels are available.	Check your area is covered by Digital Video Broadcasts. Try re-tuning or manually tuning missing channels. Check that you are using the correct antenna type.
Channel cannot be selected	Check if the channel has been blocked in the main menu settings.
USB not playing	Please check connecting USB cable and power supply is connected Hard drive has not been formatted. Please make sure USB disk is compatible and the multimedia data formats are supported.
Picture is distorted, macroblock, small block, dots, pixelization, etc	Compression of video contents may cause distortion especially on fast moving pictures such as sports and action movies.
Noise from speaker	Check cable connections, make sure a video cable is not connected to an audio input. Low signal level may cause sound distortion.
TV turns off automatically	Check if the Off Timer is set to On in the Setup menu. Sleep Timer may have been enabled. If there is no signal for about 10 minutes from an input, the TV will automatically turn off. If connected to your PC, check your PC power settings. Make sure the AC power cord is plugged in securely to the wall outlet and the TV.
TV turns on automatically	Check if the On Timer is set to On in the Setup menu.
Picture is not shown in full screen	Black bars on each side will be shown on HD channels when displaying SD (4:3) contents. Black bars on Top & Bottom will be shown on movies that have aspect ratios different from your TV. Adjust picture size option on your external device or TV to full screen.

WARNING

Never place a television set in an unstable location. A television set may fall, causing serious personal injury or death. Many injuries, particularly to children, can be avoided by taking simple precautions such as:

- Using cabinets or stands recommended by the manufacturer of the television set.
- Only using furniture that can safely support the television set.
- Ensuring the television set is not overhanging the edge of the supporting furniture.
- Not placing the television set on tall furniture (for example, cupboards or bookcases) without anchoring both the furniture and the television set to a suitable support.
- Not placing the television set on cloth or other materials that may be located between the television set and supporting furniture.
- Educating children about the dangers of climbing on furniture to reach the television set or its controls

If your existing television set is being retained and relocated, the same considerations as above should be applied.

The plug or appliance coupler is used as the disconnect device, the disconnect device shall remain readily operable.

SPECIFICATION

Model		eiq-55UHDT2HOLED
Display size		55" Diagonal (max.)
OLED panel resolution		3840X2160
Speaker output power		≥5WX2
Power supply		220-240V~, 50/60Hz
TV receive system		Digital: DVB-T/T2, DVB-C, DVB-S/S2 Analog: PAL: BG, I, DK, SECAM: BG, D/K
Frequency range		Analog: Antenna: 46.25MHz-855.25MHz Digital : DVB-T/T2: 5-12,21-69 DVB-C: 113MHz-898MHz DVB-S/S2: 950MHz-2150MHz
Video in		PAL/NTSC/SECAM
Power consumption		330W
Standby consumption		≤0.5W
Antenna input		75 ohms
Controller power		DC 3V (Two AAA size batteries)
Dimensions (LxWxH)	TV with stand	1306x231x771mm
	TV without stand	1230x41x727mm
Weight (Net weight)	TV with stand	16.2Kg
	TV without stand	15.5Kg
Work temperature		0°C-40°C

NOTES:

- Design and specifications are subject to change without notice.
- Weight and Dimension shown are approximate.

SUPPORTING SIGNALS

Input	Mode
DTV	Digital: DVB-T/T2, DVB-C, DVB-S/S2
ATV	PAL BG I DK
	SECAM BG DK
CVBS	PAL/NTSC/SECAM

Input	Resolution		Vertical Frequency
PC/VGA	VGA	640x480	60Hz
	SVGA	800X600	60Hz
	XGA	1024X768	60Hz
	SXGA	1280X1024	60Hz
		1360X768	60Hz
		1920X1080	60Hz

Input	Resolution	Vertical Frequency
Component	480i	60Hz
	480p	60Hz
	576i	50Hz
	576p	50Hz
	720p	50Hz/60Hz
	1080i	50Hz/60Hz
	1080p	50Hz/60Hz
HDMI	480p	60Hz
	576p	50Hz
	720p	50Hz/60Hz
	1080i	50Hz/60Hz
	1080p	50Hz/60Hz
	3840x2160	24Hz/25Hz/30Hz/60Hz

This TV is embedded with one digital media player. It can find devices that support USB1.1/2.0, including flash disk, USB hard disk and digital camera. It supports functions as: Display picture, Play music files, Play video files.

Note: Please do not remove the cable during the data transfer. It may cause problems for the system.

Picture	Codec	JPEG, PNG, BMP
Music	Audio Codec	MP-(1/2/3), AAC, AC3
	Container	MPG, MPEG, MP4, MKV, 3GPP, AVI, FLV
	Video Codec	HD/FHD: MPEG-(1/2/4), MVC, H.264, H.265
		UHD: H.264, H.265
	Audio Codec	MP-(1/2/3), AAC, AC3

PRODUCT DISPOSAL

Do not dispose this product as unsorted waste. Collection of such waste must be handled separately as special treatment is necessary. Recycling facilities are now available for all customers at which you can deposit your old electrical products. Customers will be able to take any old electrical equipment to participating civic amenity sites run by their local councils. Please remember that this equipment will be further handled during the recycling process, so please be considerate when depositing your equipment. Please contact the local council for details of your local household waste recycling centres.



electriQ UK SUPPORT

Complete online support form on www.electriQ.co.uk/support

Service Line: 0871 620 1057

Office hours: 9AM - 5PM Monday to Friday

www.electriQ.co.uk

Unit J6, Lowfields Business Park,

Lowfields Way, Elland

West Yorkshire, HX5 9DA